

**Toyon Elementary School**  
**Flexible Instructional Space Project**

**Berryessa Union School District**  
**MDG Project #1711**  
**CUSD Project #16-B03-24**

**October 25, 2018**

**BERRYESSA UNION SCHOOL DISTRICT**  
**SAN JOSE, CALIFORNIA**

This Addendum forms a part of the Contract Documents. Bidders must acknowledge receipt of this Addendum in the space provided on the Bid Form. Failure to do so may subject the Bidder to disqualification.

**SPECIFICATION CLARIFICATIONS:**

**Item 1: Table of Contents (Document 00 01 10):**

Replace Document 00 01 10 Table of Contents with the attached Document 00 01 10.

*The table of contents has been modified to include **Appendix A: Hazmat Abatement Report; HMD #18-159 dated October 19, 2018***

**Item 2: Bid Form (Document 00 41 26):**

Replace Document 00 41 26 Bid Form with the attached Document 00 41 26.

*The bid form has been modified to clarify that the Unit Pricing will be used to evaluate additive and/or deductive change orders only.*

**Item 3: Bid Division Descriptions (Document 01 10 12):**

Insert the following paragraph after the last paragraph in section 1.3.B.4;

Contractor shall remove, protect, and reinstall existing benches in front of Building A, quantity (3) each.

**Item 4: Hazmat Abatement Report; HMD #18-159 dated October 19, 2018:**

Include the attached document **Appendix A: Hazmat Abatement Report; HMD #18-159 dated October 19, 2018**

**Item 5: DVBE Participation Form (Document 00 91 20):**

Replace Part II of this documents with the following:

**PART II – METHOD OF COMPLIANCE WITH DVBE PARTICIPATION GOALS** – Do not include with your bid proposal. Include this form and any other applicable documents listed in this table with your Agreement between the Owner and Contractor. Read the three columns in the table below as sentences from left to right. Check the appropriate box to indicate your method of committing the contract dollar amount.

**Item 6: Notice to Bidders(Document 00 11 16):**

Replace entire document 00 11 16 with the attached Document 00 11 16:

**DRAWING CLARIFICATIONS:**

**Item 7: Toyon Library As-Builts (c1979):**

As built are included as part of this addendum for reference only.

**Attachments:**

Document 00 01 10 Table of Contents (4 pages)

Document 00 41 26 Bid Form (4 pages)

As Built Drawings: Library Addition to Toyon ES, c1979 (9 sheets)

END OF ADDENDUM 01

**DOCUMENTS 00 01 10****TABLE OF CONTENTS****DIVISION 00 – PROCUREMENT AND CONTRACTING REQUIREMENTS**

00 00 00	Title Page
00 01 10	Table of Contents
00 11 16	Notice to Bidders
00 21 13	Instructions to Bidders
00 41 26	Bid Form
00 43 13	Bid Bond
00 43 36	Designation of Subcontractors
00 43 40	Sufficient Funds Declaration
00 45 19	Non Collusion Affidavit
00 45 26	Workers' Compensation Certification
00 45 28	Drug Free Workplace Certification
00 45 30	Roof Project Certification
00 45 32	Fingerprinting Notice and Acknowledgement
00 45 34	Iran Contracting Act Certification
00 50 50	Notice of Intent to Award
00 51 00	Notice of Award
00 52 26	Agreement between Owner and Contractor
00 54 00	Escrow Bid Documentation
00 54 26	Escrow Agreement for Security Deposits in Lieu of Retention
00 55 00	Notice to Proceed
00 61 13.13	Performance Bond
00 61 13.16	Payment Bond
00 72 00	General Conditions
00 73 00	Special Conditions
00 73 73	Compliance Monitoring and Enforcement Notice
00 81 00	Hazardous Materials Procedures and Requirements
00 88 00	Agreement and Release of Any and All Claims
00 89 00	Guarantee Form
00 91 20	Certification of Disabled Veteran Business Enterprise Participation
00 91 20	DVBE Good Faith Effort Worksheet
00 92 00	Smoke-Free Environmental Certification
00 92 50	Asbestos and Other Hazardous Materials Certification
00 93 00	Lead-Based Paint Certification
00 93 50	Imported Materials Certification

**DIVISION 01 – GENERAL REQUIREMENTS**

01 10 00	Summary
01 10 12	Bid Division Descriptions
01 10 28	Post Bid Descriptions
01 20 00	Price and Payment Procedures
01 20 10	Forms for Contractors' Use
01 21 00	Allowances
01 22 00	Unit Prices
01 23 00	Alternates & Unit Pricing
01 25 00	Substitution Procedures
01 30 00	Administrative Requirements
01 32 16	Construction Progress Schedule
01 40 00	Quality Requirements
01 50 00	Temporary Facilities and Controls
01 60 00	Materials and Equipment
01 60 05	Product Requirements
01 61 00	Delivery, Storage and Handling
01 70 00	Execution and Closeout Procedures
01 72 00	Field Engineering
01 77 00	Closeout Procedures
01 78 00	Closeout Submittals

**DIVISION 02 – EXISTING CONDITIONS**

02 41 19	Selective Demolition
----------	----------------------

**DIVISION 03 – CONCRETE**

03 10 00	Concrete Formwork
03 30 00	Cast-in-Place Concrete
03 35 00	Polished Concrete Finishing

**DIVISION 06 – WOOD, PLASTIC, AND COMPOSITES**

06 10 00	Rough Carpentry
06 20 00	Finish Carpentry
06 41 00	Custom Casework

**DIVISION 07 – THERMAL AND MOISTURE PROTECTION**

07 92 00	Joint Sealers
----------	---------------

**DIVISION 08 – OPENINGS**

08 11 13	Standard Steel Frames
08 11 14	Steel Doors
08 14 00	Wood Doors



08 71 00 Door Hardware  
08 80 00 Glazing

**DIVISION 09 – FINISHES**

09 21 16 Gypsum Board Assemblies  
09 51 14 Acoustical Ceiling Panels-Lay In  
09 51 23 Acoustical Tile Ceilings (Glue-Up Ceilings)  
09 65 13 Top-set Resilient Base  
09 68 16 Sheet Carpeting  
09 91 00 Painting

**DIVISION 10 – SPECIALTIES**

10 11 16 Marker Boards  
10 14 00 Parking Area Signs  
10 14 10 Room Signage  
10 14 11 Restroom Signs  
10 21 13 Solid Plastic Toilet Partitions  
10 28 00 Toilet & Bath Accessories  
10 44 16 Fire Extinguishers

**DIVISION 12 – FURNISHINGS**

12 24 13 Roller Shades

**DIVISION 22 – PLUMBING**

22 05 00 Common Work Results for Plumbing

**DIVISION 23 – HEATING, VENTILATION AND AIR CONDITIONING**

23 05 00 Basic mechanical Materials and Methods

**DIVISION 26 – ELECTRICAL**

26 00 00 Electrical General Requirements  
26 05 00 Basic Electrical Materials and Methods  
26 05 23 Conductors and Cables  
26 05 26 Grounding and Bonding  
26 05 33 Raceways and Boxes  
26 05 53 Electrical Identification  
26 09 23 Lighting Control Devices  
26 27 26 Wiring Device  
26 28 16 Enclosed Switches and Circuit Breakers  
26 51 00 Lighting

**DIVISION 27 – COMMUNICATIONS**

27 00 00 Data / Telephone System  
27 51 17 Assistive Learning System

**DIVISION 28 – ELECTRONIC SAFETY AND SECURITY**

28 31 00 Fire Alarm System

**DIVISION 32 – EXTERIOR IMPROVEMENTS**

32 12 16 Asphalt Paving

32 13 13 Cement Concrete Paving

32 17 23 Pavement Markings – Parking

32 17 26 Cast-in-Place Detectable / Tactile Warning Surfaces

32 31 13 Chain Link Fencing & Gates

**Appendix A:** Hazmat Abatement Report; HMD #18-159 dated October 19, 2018

END OF TABLE OF CONTENTS

DOCUMENT 00 41 26

**BID FORM**

Berryessa Union School District  
1376 Piedmont Road  
San Jose, CA 95132

Dear Board Members:

The undersigned doing business under the firm name of:

\_\_\_\_\_ hereby propose and agree to enter into a Contract, to furnish any and all labor, materials, applicable taxes, equipment and services for the completion of Work described hereinafter and in the Contract Documents:

**TOYON ELEMENTARY SCHOOL FIS PROJECT  
995 Bard St, San Jose, CA 95127**

prepared by:                    Kitchell CEM  
   1180 Coleman Ave  
   San Jose, CA 95110

for the amount of:

1) <u>Allowance for Unforeseen Conditions</u>	<u>One Hundred Thousand dollars,</u>	<u>\$ 100,000.00</u>
2) _____	Dollars \$ _____	
<b><i>TOTAL BASE BID:</i></b> (Add 1+2)		Dollars \$ _____

11.1.6.1            HAZMAT UNIT PRICES  
Contractor shall bid all quantities listed in the Appendix-A of the Asbestos Abatement and Lead Paint Stabilization Project Specifications under Base Bid. Any and all additional and/or deductions shall be based on the Abatement Unit Prices (Appendix-B) of the said specifications. Contractor is to attach the Unit Prices (Appendix-B) to this Bid Form.

11.1.6.2 UNIT PRICES. Contractor shall bid all quantities listed, which the Bidder must provide and the District may, at its discretion, utilize in valuing additive and/or deductive change orders:

<p><b>Unit Price 1:</b> Concrete walkway - replacement – 10’X10’ area.</p> <p>see spec section 01 23 00 for additional information.</p>	<p>Cost per square foot</p> <p>\$ _____ sf</p>	<p>Total Unit Cost 1</p> <p>\$</p>
<p><b>Unit Price 2:</b> AC paving – replacement - 10’x10’ per area.</p> <p>see spec section 01 23 00 for additional information.</p>	<p>Cost per square foot</p> <p>\$ _____ sf=</p>	<p>Total Unit Cost 2</p> <p>\$</p>
<p><b>Unit Price 3:</b> Tackable Wall Panel - 100-sf area.</p> <p>see spec section 01 23 00 for additional information.</p>	<p>Cost per square foot</p> <p>\$ _____ sf =</p>	<p>Total Unit Cost 3</p> <p>\$</p>
<p><b>Unit Price 4:</b> Chain Link Gate w/Kickplate – per occurrence (each).</p> <p>see spec section 01 23 00 for additional information.</p>	<p>Cost per occurrence (each).</p> <p>\$ _____ ea =</p>	<p>Total Unit Cost 4</p> <p>\$</p>
<p><b>Unit Price 5:</b> Chain Link Fencing – 50 LF increments.</p> <p>see spec section 01 23 00 for additional information.</p>	<p>Cost per linear foot (LF)</p> <p>\$ _____ lf =</p>	<p>Total Unit Cost 5</p> <p>\$</p>
<p><b>Unit Price 6:</b> Ornamental Fencing – 50 LF increments.</p> <p>see spec section 01 23 00 for additional information.</p>	<p>Cost per linear foot (LF)</p> <p>\$ _____ lf =</p>	<p>Total Unit Cost 5</p> <p>\$</p>

11.1.6.3 COURSE-OF-CONSTRUCTION INSURANCE REQUIREMENTS

Contractor, during the progress of the Work and until final acceptance of the Work by Owner upon completion of the entire Contract, shall maintain Builder’s Risk/Course-of-Construction insurance satisfactory to the Owner, issued on a completed value basis on all insurable Work included under the Contract Documents. This insurance shall insure against all risks, including but not limited to the following perils: vandalism, theft, malicious mischief, fire, sprinkler leakage, civil authority, sonic boom, explosion, collapse, flood, earthquake (for projects not solely funded through revenue bonds, limited to earthquakes equivalent to or under 3.5 on the Richter Scale in magnitude), wind, hail,

lightning, smoke, riot or civil commotion, debris removal (including demolition) and reasonable compensation for the Architect's services and expenses required as a result of such insured loss. This insurance shall provide coverage in an amount not less than the full cost to repair, replace or reconstruct the Work. Such insurance shall include the Owner, the Architect, and any other person or entity with an insurable interest in the Work as an additional named insured.

The Contractor shall submit to the Owner for its approval all items deemed to be uninsurable under the Builder's Risk/Course-of Construction insurance. The risk of the damage to the Work due to the perils covered by the Builder's Risk/Course-of-Construction insurance, as well as any other hazard which might result in damage to the Work, is that of the Contractor and the surety, and no claims for such loss or damage shall be recognized by the Owner, nor will such loss or damage excuse the complete and satisfactory performance of the Contract by the Contractor.

If written notice of the Award of Contract is mailed, faxed, or delivered to the undersigned at any time before this bid is withdrawn, the undersigned shall, within ten (10) days after the date of such mailing, faxing, or delivering of such notice, execute and deliver an agreement in the form of agreement present in these Contract Documents and give Performance and Payment Bonds in accordance with the specifications and bid as accepted.

The undersigned hereby designates as the office to which such Notice of Award of Contract may be mailed, faxed, or delivered:

\_\_\_\_\_

Our Public Liability and Property Damage Insurance is placed with:

\_\_\_\_\_

Our Workers' Compensation Insurance is placed with:

\_\_\_\_\_

Circular letters, bulletins, addenda, etc., bound with the specifications or issued during the time of bidding are included in the bid, and, in completing the Contract, they are to become a part thereof.

The receipt of the following addenda to the specifications is acknowledged:

Addendum No. \_\_\_\_\_ Date \_\_\_\_\_ Addendum No. \_\_\_\_\_ Date \_\_\_\_\_  
Addendum No. \_\_\_\_\_ Date \_\_\_\_\_ Addendum No. \_\_\_\_\_ Date \_\_\_\_\_

This bid may be withdrawn at any time prior to the scheduled time for the opening of bids or any authorized postponement thereof.

A bidder shall not submit a bid unless the bidder's California contractor's license number appears clearly on the bid, the license expiration date and class are stated, and the bid contains a statement that the representations made therein are made under penalty of perjury. Any bid submitted by a contractor who is not licensed pursuant to Business and

Professions Code section 7028.15 shall be considered nonresponsive and shall be rejected. Any bid not containing the above information may be considered nonresponsive and may be rejected.

**NOTE:** Each bid must give the full business address of the bidder and be signed by bidder with bidder's usual signature. Bids by partnerships must furnish the full name of all partners and must be signed in the partnership name by a general partner with authority to bind the partnership in such matters, followed by the signature and designation of the person signing. The name of the person signing shall also be typed or printed below the signature. Bids by corporations must be signed with the legal name of the corporation, followed by the name of the state of incorporation and by the signature and designation of the chairman of the board, president or any vice president, and then followed by a second signature by the secretary, assistant secretary, the chief financial officer or assistant treasurer. All persons signing must be authorized to bind the corporation in the matter. The name of each person signing shall also be typed or printed below the signature. Satisfactory evidence of the authority of the officer signing on behalf of a corporation shall be furnished.

The undersigned declares under penalty of perjury under the laws of the State of California that the representations made in this bid are true and correct.

Print or Type Name: \_\_\_\_\_

Title: \_\_\_\_\_

Name of Company as Licensed: \_\_\_\_\_

Business Address: \_\_\_\_\_

\_\_\_\_\_

Telephone Number: \_\_\_\_\_

California Contractor License No.: \_\_\_\_\_

Class and Expiration Date: \_\_\_\_\_

State of Incorporation, if Applicable: \_\_\_\_\_

( ) Evidence of authority to bind corporation is attached.

Dated: \_\_\_\_\_, \_\_\_\_\_

Signed: \_\_\_\_\_

END OF DOCUMENT

**ASBESTOS, LEAD and PCB ABATEMENT  
PROJECT SPECIFICATIONS**

**TOYON ELEMENTARY SCHOOL  
995 BARD STREET  
SAN JOSE, CA 95132**

**BUILDING 'H' – OLD LIBRARY AREAS**

**BUESD – TOYON ES FLEXIBLE INSTRUCTION SPACE  
RENOVATION PROJECT**

**Prepared for:  
BERRYESSA UNION ELEMENTARY SCHOOL DISTRICT  
945 PIEDMONT ROAD  
SAN JOSE, CA 95132**

OCTOBER 19, 2018

HMD Project # 18-159

**Prepared by:  
HAZMAT DOC  
3080 OLCOTT STREET • SUITE 135 D  
SANTA CLARA, CA 95054  
Tel: 408.748.0055**

## CONTENTS

### SECTION 02 82 00 - ASBESTOS ABATEMENT

<b>SUB-SECTION</b>		<b>Page No.</b>
00	General Asbestos Removal Specifications	1
01	General Requirements	8
02	Labor, Materials and Equipment	25
03	Execution	27
04	Special Procedures	39
05	Inspections, Project Management, Air Monitoring and Completion	50
06	Alternate Procedures and Violations of Specifications	56
07	Emergency Planning	57
08	Fire Safety and Safe Egress	58

### SECTION 02 83 00 - LEAD ABATEMENT

<b>SUB-SECTION</b>		<b>Page No.</b>
01	General Lead Removal Specifications	1
02	Materials and Equipment	13
03	Execution	15

### SECTION 02 84 00 - POLYCHLORINATED BIPHENYLS (PCB) AND FLUORESCENT LIGHT BULB/TUBE REMOVAL

<b>SUB-SECTION</b>		<b>Page No.</b>
01	General	0
02	Products	4
03	Execution	5

### APPENDICES

- A. SCOPE OF WORK
- B. ABATEMENT UNIT PRICES



**SECTION 02 82 00  
ASBESTOS-ABATEMENT**

**SUB-SECTION 00  
GENERAL ASBESTOS REMOVAL SPECIFICATIONS**

**INTRODUCTION**

These asbestos removal specifications are necessarily general and are intended only to give a description of what is required to adequately complete an asbestos abatement project. The asbestos abatement project is accompanied by a job-specific SCOPE-OF-WORK (attached as an appendix to this document), which summarizes the procedures, describes the extent and nature of the asbestos removal or abatement, and may detail any special conditions at the job site. These specifications are not intended to cover all variations that may occur, however, a field directive will address unanticipated variations.

**TERMS AND DEFINITIONS**

The following section is a list of terms and definitions that will be used in this specification.

**Abatement:** Procedures to control fiber release from asbestos-containing materials (ACM). Includes encapsulation, enclosure and removal.

**Accredited:** A person who holds a current certificate of training or updated certificate of continuing training as required by Federal and State regulations.

**AHERA:** The Asbestos Hazard Emergency Response Act of 1986, also referred to as the Asbestos-Containing Materials in Schools; Final Rule and Notice, and 40 CFR Part 763

**Asbestos:** Means the asbestiform varieties of serpentine, Chrysotile, riebeckite (crocidolite) cummingtonite-grunerite, anthophyllite and actinolite-tremolite

**Asbestos-Containing Construction Material (ACCM):** Term used by Cal/OSHA to describe construction materials that contain asbestos in amounts greater than one-tenth of one percent (0.1%) either alone or mixed with fibrous or non-fibrous materials..

**Asbestos-Containing Material (ACM):** Any material or product that contains more than 1 percent (1%) asbestos as determined by Polarized Light Microscopy (PLM) analysis, or assumed to contain greater than 1 percent asbestos.

**Airlock:** A system for permitting ingress or egress without permitting air movement between a contaminated area and an uncontaminated area, typically consisting of two curtained doorways at least 3 feet apart.

**Air Monitoring:** The process of measuring the fiber content of a specific volume of air in a stated period of time in an appropriate location.

**Ambient Air:** The air outside a building or structure OR the air as it normally exists in a space prior to activity

**Amended Water:** Water to which a surfactant has been added.

**Authorized Visitor:** Owner, HazMat Project Manager, or representative of any regulatory or other agency having jurisdiction over the project.

**Cal/OSHA:** California Division of Occupational Safety and Health

**Clean Room:** An uncontaminated area or room that is part of the worker decontamination unit, with provisions for storage of uncontaminated clothing and equipment.

**HazMat Project Manager:** An asbestos consulting company and its employees retained by Owner, which employs a full-time HazMat Project Manager who is qualified to perform asbestos consulting services.

**Containment:** The temporary, polyethylene-lined, enclosure structure erected to control the release of asbestos fibers to the ambient environment.

**Contractor:** An asbestos abatement contracting company and its employees, which employs a full-time contractor who is certified to provide asbestos abatement services, and whose employees hold current applicable accreditation.

**Critical Barrier:** A unit of temporary construction that provides the only separation between the asbestos work area and an adjacent area. This includes the decontamination unit, perimeter walls, ceiling penetrations and any temporary barriers between the work area and outside environment.

**Curtained Doorway:** A device to allow entry or exit from one room to another while permitting minimal air movement between the two rooms, typically constructed by placing two overlapping sheets of polyethylene over an existing or temporary framed doorway, securing the vertical edge of one sheet along one vertical side of the doorway, and securing the vertical edge of the other sheet along the opposite vertical side of the doorway.

**CSLB** California Contractors State License Board

**Decontamination Unit:** A series of connected rooms, each room being an airlock, with curtained doorways between any two adjacent rooms, for the decontamination of workers or of materials and equipment.

**Demolition:** The wrecking or taking out of any non structural building material, casework, surface mounted items or surfaces of a facility together with any related transportation and disposal, and any related razing, removing, or stripping of asbestos products.

**Debris Box/Dumpster:** Synonymous with waste container. All debris boxes/dumpsters used on this project shall be hard sided including a hard lid, locked at all times when not in use and placed in an owner designated location.

**DOP:** Dioctylphthalate particles which are used to test the efficiency of HEPA filtration equipment. Substitutes such as Di [2-ethyhexyl] phthalate, PAO (Emery 3004), DOS (Dioctyl-sebacate) may be utilized with prior written permission from the Project Manager.

**DOSH:** California Department of Industrial Relations, Division of Occupational Safety and Health

**Encapsulant :** A liquid material that can be applied to ACM or surfaces stripped of ACM and that controls the possible release of asbestos fibers from the material either by creating a membrane over the surface (bridging encapsulant) or by penetrating into the material and binding its components together (penetrating encapsulant). When used, care must be taken that any re-insulation material will adhere to the encapsulant.

**Encapsulant (Lock-down) :** A liquid designed to mist the air within a containment area after the containment has passed visual clearance by the HazMat Doc Project Manager. Lock-down encapsulant is designed to bind asbestos fibers together and create a sticky surface, allowing asbestos fibers to adhere to it.

**Encapsulation:** All herein specified procedures necessary to coat surfaces from which ACM has been removed with sealing substance meeting applicable government standards. Encapsulation may also be referred to as "lock-down" encapsulation.

**EPA:** US Environmental Protection Agency.

**Equipment Decontamination Unit:** A decontamination unit for materials and equipment, typically consisting of a designated area of the work area, a washroom, holding area, and an uncontaminated area.

**Equipment Room:** A contaminated area or room that is part of the worker/equipment decontamination unit, with provisions for storage of contaminated clothing and equipment.

**Friable ACM:** Asbestos-containing material that can be crumbled, or reduced to a powder by ordinary hand pressure, or materials assessed as friable by an accredited asbestos abatement inspector.

**Fixed Object:** A piece of equipment or furniture in the work area that cannot or will not be removed from the work area, by Owner's decision.

**Full Containment/Enclosure:** Full containment/enclosures shall be constructed of two layers of 6-mil polyethylene sealing all surfaces, in all locations not being abated during the current phase of abatement. The sheeting must be secured in a manner that shall maintain the integrity of containment throughout removal and testing.

**Glovebag Technique:** A method with limited applications for removing small amounts of friable asbestos-containing material(s) from ducts, short pipe-runs, valves, joints, elbows and other non-planar surfaces. The glovebag assembly is a manufactured or fabricated device consisting of a glove bag (typically constructed of 6-mil transparent polyethylene or polyvinylchloride sheeting), two inward projecting long sleeves, an internal tool pouch and an attached. Labeled receptacle for asbestos waste. The glove bag is constructed and installed in such a manner that it surrounds the object or material to be removed and contains all asbestos fibers released during the process. Glove bags must meet the specification requirements for glove bags as listed in 8 CCR 1529. All workers who are permitted to use the glove bag technique must be trained, experienced and skilled in this method. All techniques and procedures employed by the contractor shall be approved by the HazMat Doc Project Manager.

**HEPA Filter:** A High Efficiency Particulate Air (HEPA) filter that traps and retains at least 99.97% of mono-dispersed particles 0.3 microns in diameter or larger.

**HEPA-Filtered Exhaust Unit:** An exhaust fan that draws contaminated air through a HEPA filter and exhausts the filtered air to the outside of the building.

**HEPA-Filtered Vacuum:** High efficiency particulate air filtered vacuuming equipment with a filter system that collects and retains 99.97% of mono-dispersed particles 0.3 microns in diameter or larger.

**Holding Area:** A room between the washroom and an uncontaminated area in the equipment decontamination unit. The holding area has an airlock constructed at its entrance from an uncontaminated area.

**HVAC:** Heating, ventilation and air conditioning system

**Manometer:** Instrument for measuring the static air-pressure differential across a barrier. This project requires at least one properly calibrated and fully functional manometer at each containment. Manometer units shall, at a minimum, be factory calibrated once a year.

**Mini-Containment/Enclosure:** Mini-enclosures may be used where glove bag setups are not feasible. The use of these must be pre-approved by the HazMat Project Manager. Mini-enclosures shall be constructed of 6-mil polyethylene (attached with tape and/or glue to walls and floors) and shall be small enough for a maximum for two workers who can enter the enclosure one at a time, complete the abatement process, pass out the debris (appropriately contained) and exit. The workers shall have available a change room contiguous to the work area where they can remove their coveralls prior to leaving the area.

**Monitoring:** May include

- (i) Visual inspection for the presence of visible emissions; or
- (ii) Air monitoring performed in accordance with accepted methods;
- (iii) Collecting core samples or encapsulated or bridged materials;
- (iv) Collecting bulk samples of soil during and following abatement;

**Moveable Object:** A piece of equipment or furniture in the work area that can be removed from the work area.

**Non-friable ACM:** Asbestos-containing material that does not crumble, or become reduced to powder by ordinary hand pressure, or material that has been assessed as non-friable by an accredited asbestos abatement inspector.

**Owner:** Individual or entity that owns the property and its employees, representatives or agents.

**PLM:** Polarized Light Microscopy. Asbestos analysis of bulk material via EPA 600/R-93/116 Method using Polarized Light Microscopy.

**Pressure Differential:** A condition whereby the containment is maintained at a pressure differential of at least minus 0.02 inches of water relative to the adjacent unsealed areas.

**Regulated Area:** An area established by a contractor to demarcate areas where airborne concentrations of asbestos exceed, or could potentially exceed, the PEL.

**Regulations:** ALL relevant Local, State and Federal Regulations

**Removal:** All specified procedures necessary to strip all ACM from the designated areas and dispose of these materials at an acceptable site.

**Renovation:** The modifying of any existing structure, or portion (component) thereof.

**Scope-of-Work:** Project specific removal tasks to be utilized in conjunction with these specifications. If a conflict arises the most stringent requirement shall apply.

**Shower Room:** A room in the worker decontamination unit that is located between the clean room and equipment room, and is equipped with a functional shower stall with hot and cold water and a waste water filtering system.

**Surfactant:** A non-toxic, non-flammable, chemical wetting agent added to water to improve penetration, thus reducing the quantity of water required for a given operation or area.

**Supervisor:** An employee of Contractor who is accredited as a Supervisor for Asbestos Abatement Projects, qualifies as a competent person on asbestos abatement projects, and holds current applicable accreditation.

**Structural Member:** Any load-bearing member, such as a beam, load-bearing walls or non-load bearing members such as ceilings and non load-bearing walls.

**TEM:** Transmission Electron Microscopy performed by EPA 40 CFR part 763 Final Rule (AHERA). Per AHERA specifications a Level II analysis on all AHERA jobs.

**Visible Emissions:** Any emissions, whether containing particulate material or not, that are detectable without the aid of instrumentation. Not including condensed UNCOMBINED water vapor.

**Waste Containers:** Synonymous with debris boxes/dumpsters. All waste containers used on this project shall be labeled, hard sided including a hard lid, locked at all times when not in use and placed in an owner designated location.

**Washroom:** A room between the work area and the holding area in the equipment decontamination unit. The washroom has an airlock between it and the holding area.

**Wet-Clean:** The process of eliminating asbestos contamination from building surfaces and objects by using cloths, mops, or other cleaning tools that have been dampened with amended water, and by afterwards disposing of these cleaning tools as asbestos-containing waste.

**Work Area:** The area of a building where asbestos-containing materials will be, or are being, removed or abated.

**Worker:** An individual who has successfully completed an initial US EPA and/or State approved accreditation course and who has maintained that certificate by attending mandated refresher training and possesses valid and current AHERA-accreditation documents.

**Worker Decontamination Unit:** A decontamination enclosure system for workers, typically consisting of a clean room, a shower room, and an equipment room.

## ABBREVIATIONS AND ACRONYMS

The following acronyms or abbreviations as referenced in this contract document are defined to mean these associated names. Both names and addresses are subject to change, and are believed to be, but are not assured to be, accurate and up-to-date as of date of this contract document:

ACM	Asbestos-Containing Materials >1%
ACCM	Asbestos Containing Construction Material greater than 1/10 <sup>th</sup> of 1 percent asbestos (i.e. 0.10% or greater)
ACRM	Asbestos-Containing Roofing Materials
AHERA	Asbestos Hazard Emergency Response Act; refers to EPA regulation 40 CFR Part 763 entitled "Asbestos-Containing Materials in Schools" in Vol. 52, No. 210, October 30, 1987.
AIA	American Institute of Architects
ASTM	American Society for Testing and Materials
ASHRAE	American Society for Heating, Refrigerating, and Air Conditioning Engineers
ASTM	American Society for Testing and Materials
Cal-OSHA	California Division of Occupational Safety and Health
CFR	Code of Federal Regulations
CGA	Compressed Gas Association
CS	Commercial Standard of NBS (U.S. Dept. of Commerce)
CSLB	Contractors State Licensing Board (California)
DOT	U.S. Department of Transportation
EPA	U.S. Environmental Protection Agency and by inference the local air pollution control agency or any other entity designated as a representative of the EPA
GSA	General Services Administration
HEPA	High Efficiency Particulate Air
HPM	Hazmat Project Manager
HVAC	Heating, Ventilating and Air-Conditioning
NBS	National Bureau of Standards
NEC	National Electrical Code (by NFPA)
NFPA	National Fire Protection Association
NESHAPs	National Emission Standards for Hazardous Air Pollutants (40 CFR Part 61)
NIOSH	National Institute for Occupational Safety and Health
NIST	National Institute of Standards and Technology, U.S. Dept. of Commerce
NVLAP	National Voluntary Laboratory Accreditation Program
OSHA	Occupational Safety & Health Administration
PAT	NIOSH Proficiency Analytical Testing Program
PCM	Phase Contrast Microscopy - Analytical Method used to determine airborne concentrations of asbestos fibers according to NIOSH Method 7400
PEL	Permissible Exposure Limit - OSHA allowable 8 hour TWA personal exposure above which employees are required to wear appropriate respiratory and personal protective equipment
PLM	Polarized Light Microscopy - Analytical method used to determine asbestos content in bulk material samples.
psi	Pressure expressed in pounds per square inch
ppm/v	Unit as expressed in parts per million by volume
SDS	Safety Data Sheet
STEL	Short Term Exposure Limit - OSHA allowable 30 minute TWA personal exposure above which employees are required to wear appropriate respiratory and personal protective equipment

TEM	Transmission Electron Microscopy - Analytical method used to identify and determine airborne concentrations of asbestos fibers according to EPA AHERA protocol.
TSCA	U.S. Toxic Substances Control Act of 1976
TWA	Time-Weighted-Average - Average unit of exposure to a substance over a general period of time
UL	Underwriters Laboratories

**SUB-SECTION 01  
GENERAL REQUIREMENTS**

**1.1 GENERAL**

**1.1.1 Description Of Work And Contractor Responsibilities**

This specification covers removal and disposal of materials identified as Asbestos-Containing Material (ACM) and/or Asbestos Containing Construction Material (ACCM) in independently prepared bulk material analysis reports, and removal and disposal of related materials.

- A. Furnish all labor, tools, materials, equipment, employee training and testing, permits, waste disposal services necessary for and reasonably incidental to the completion of removal and disposal of all Asbestos-Containing Material (ACM) and/or Asbestos Containing Construction Material (ACCM) from within the subject Buildings as denoted in the attached scope of work section of these documents. All work shall be performed in accordance with prevailing Local, State and Federal Regulation, including but not limited to the US Environmental Protection Agency (EPA), the Occupational Safety and Health Administration (OSHA), the State of California Division of Occupational Safety and Health (DOSH), the State of California Department of Industrial Relations (DIR), the recommendations of the National Institute of Occupational Safety and Health (NIOSH) and any and all other regulations. Where a conflict or overlap of regulations occurs, the MOST stringent shall apply.
- B. The asbestos abatement work as specified herein shall be performed as required to accommodate final aggressive air clearance testing of all interior work sites where standard negative air enclosures have been established, and satisfactory visual inspections for asbestos abatement which takes place on exterior building components. None of the negative air enclosures shall be removed until visual inspections and clearance testing results are satisfactory for the contained work site(s), nor the barricades removed until the final visual inspections are satisfactory for the exterior removal sites inspected.
- C. This is a calendar day contract. Weekends, holidays, etc., are regular working days for the purposes of this contract. The specific daily work schedules and timing for each area of asbestos-containing materials abatement in this project shall be coordinated with, and approved by the HPM, and then specified in the Contractor's asbestos abatement plan, prior to commencing work.
- D. Description of Asbestos-Containing Materials to be removed.  
Known ACM/ACCM that must be removed under this contract are listed in the attached Appendix. Determination of the actual quantities of these ACM/ACCM and related ACM/ACCM debris shall be the responsibility of the selected Contractor. In addition to these ACM/ACCM described below, the selected Contractor shall be responsible for the proper abatement of any incidental ACM/ACCM that is necessary to accomplish work of this project. Contractors who chose to submit a bid to perform this work, shall estimate quantities of listed as well as incidental ACM/ACCM by a visual assessment of the ACM/ACCM within the building(s) as illustrated in the attached Appendix.
- E. Quantity of Asbestos-Containing Materials.  
The actual determination of quantities and measurements of the asbestos-containing materials, related debris and contaminated materials within this building will be the responsibility of the Contractor. The Contractor shall deal with any encounters of these asbestos-containing materials, related debris and contaminated materials in full accordance with all applicable federal, state and local laws, rules and regulations. All related costs shall be included in the basic contract price. If, during the course of work, the Contractor encounters other materials in these areas or other areas not specified above suspected to contain asbestos, which could require disturbance, clean-up or removal, he shall halt work and immediately notify the HPM for a positive determination of asbestos content and instruction as to procedure.



- F. Suspect Asbestos-Containing Materials.  
For any types of extensive, non-incident asbestos-containing materials (ACM/ACCM) which are encountered during construction, and which are not specified above, if so directed by the HPM, the Contractor shall remove and dispose of such materials according to the methods specified herein by appropriate change order. All such materials shall be quantified by the HPM and the cost agreed upon by the Contractor and the Owner prior to commencing any asbestos abatement work.
- G. Known ACM/ACCM to Remain in Place.  
Other ACM/ACCM material may exist in locations not impacted by this scope of work. All ACM/ACCMs in the building(s) may not be designated for abatement and are to remain in their existing condition/location. The Contractor shall secure any known/suspect ACM/ACCM as may be impacted by their activities in the course of accomplishing the existing scope-of-work. The provisions for securing these materials shall be described in the Contractor's abatement plan, and approved by HPM prior to any activity.
- H. Construction Schedule.  
The construction schedule is attached elsewhere in these documents. The schedule may be corrected by addendum or otherwise in writing by the owner to the contractor. Work shall be accomplished in accordance with this schedule. Any delay in the completion of the work denoted in the attached Scope of Work may subject the contractor to financial and other damages as denoted in the bid section of these documents.
- I. Description of Work.  
Asbestos abatement work includes the complete and proper removal and disposal of all asbestos-containing materials, related ACM/ACCM debris and contaminated materials within the areas identified and using the procedures specified herein.
- J. Description of Work Sites.  
For each separately enclosed interior work site, provide a decontamination unit, negative air filtration system, negative pressure monitoring device, and all other requirements of these specifications.
- K. Project Conditions.  
Specific work areas of the building will not be occupied by the Owner or the general public during the work performed under this contract. The building is to be remodeled and/or renovated. If the Contractor hires any Sub-contractors (Subs) to perform any part of this work, all such Subs shall be notified of the locations of asbestos abatement activities and the schedule of such activities in accordance with these specifications, and as required by OSHA 29 CFR 1926.1101 (k). The Contractor shall coordinate with the Owner all activities such as waste load-out or periods of electrical power outage or usage that could effect nearby work areas or adjacent buildings. Sources for electricity and water will be discussed at the pre-bid conference.

The owner may or may not provide electricity, water and sanitation (toilet) facilities at the owners discretion. It is the contractors' responsibility to furnish all power, water and sanitation requirement for the project. All costs associated with this are to be built in to the contractors base cost.

### 1.1.2 Related Work

- A. Related work includes all work necessary for successful completion of removal and disposal of ACM/ACCM but not directly involving ACM/ACCM. This work includes but is not limited to:
1. Protection of the building and property in the building from work related damage.
  2. Proper cleaning and/or disposal of contaminated and non-contaminated materials.
- B. Related work includes the maintenance of daily work logs by Contractor on the job site. These work logs shall be supplied to HazMat Project Manager by Contractor and must include:

1. The name of each person, and description of the type of respiratory protection worn by each person entering containment or work area.
2. Descriptions of meetings or discussions regarding the job, special or unusual events, records of daily containment inspections as required by 1926.1101(o)(2), records of waste removal from containment, the chart from the recording manometer, and air monitoring results.
3. HazMat Project Manager shall examine Contractor's daily work log for completeness, and sign each page at the end of each shift.
4. A copy of this daily work log, signed by Supervisor must be submitted to HazMat Project Manager at the end of the project as a condition for completion.

### **1.1.3 Project Completion**

The project shall be deemed complete and Contractor released upon satisfaction of all terms and conditions of this specification, including:

1. All required forms, logs, and receipts and satisfactory completion of air testing and site inspection by HazMat Project Manager.
2. A release letter shall be provided to Contractor by HazMat Project Manager at this time.

### **1.1.4 Work Schedule**

Upon receipt of notification to proceed with a specific project by Owner, Contractor must file all notices to the applicable regulatory agencies, and obtain all required permits to perform the asbestos abatement. Contractor must submit to Owner a notarized affidavit that notifications have been sent to the applicable regulatory agencies, as well as a copy of the notification of asbestos abatement. Upon commencement of work, Contractor must complete the project within the time specified in the schedule.

### **1.1.5 Contractor Responsibilities**

- A. Contractor represents that Contractor and its employees are experts in asbestos removal with full knowledge of, and compliance with, all applicable Federal, State, and Local rules, regulations, and guidelines governing asbestos removal as well as state-of-the-art removal techniques.
- B. Contractor must furnish all permits, labor, material, services, insurance, tools, equipment, and notifications in accordance with EPA, OSHA, State, and all other applicable agencies to complete removal of ACM/ACCM.
- C. Contractor must attend a pre-construction meeting to be held at a mutually agreeable time and date. Attending this meeting will be Owner, Contractor, Supervisor, and HazMat Project Manager.
  1. Abatement Contractor Supervisor assigned to project must attend this meeting.
  2. All pre-construction submittals by Contractor will be reviewed at this meeting. Contractor shall be prepared to discuss and submit plans or documentation for:
    - a. Preparation of work area;
    - b. Personal protective equipment;

- c. Historical air monitoring data that shows levels of airborne fibers on similar jobs in the past;
  - d. Employee training certificates;
  - e. Decontamination procedures;
  - f. Abatement methods and procedures;
  - g. Handling and disposal procedures for ACM/ACCM;
  - h. Final decontamination and cleanup procedures;
  - i. Sequence and schedule of work;
  - j. Emergency procedures;
  - k. Respiratory Protection Program including evidence of respiratory protection training and current respirator fit tests;
  - l. Owner's Safety requirements;
  - m. Any site specific owner requirements;
3. There will be a final walk-through of the building and discussion of plans, anticipated problems, and areas of special concern.
- D. If Owner permits Contractor to use any of its equipment, tools, utilities, or facilities, such use shall be gratuitous and Contractor shall release and hold harmless Owner from any responsibility arising from claims or personal injuries, including death, arising out of the use of such equipment, tools, or facilities irrespective of the condition thereof or any negligence on the part of Owner in permitting its use.
- E. Should Contractor fail or be unable to execute the contract and complete the work for any reason, then Contractor shall be penalized in accordance with agreements stated in contract documents.
- F. Owner retains the right to stop work by and/or dismiss Contractor for any breach of specified procedures, including but not limited to airborne fiber levels exceeding 0.01 fibers/cc outside the containment. Dismissal of Contractor may also result in claims against Contractor in accordance with agreements stated in contract documents.
- G. Inspections: Inspections of work area will be made by HazMat Project Manager at scheduled intervals during the course of the project. It is Contractor's responsibility to ensure that:
- 1. Work area is initially cleaned and properly prepared for removal of ACM/ACCM.
  - 2. Asbestos-containing materials are being properly removed and disposed.
  - 3. Employees of Contractor are properly protected.
  - 4. All asbestos-containing materials have been removed and disposed in accordance with the procedures contained in these specifications and scope-of-work.
- H. The inspections will merely confirm that these conditions have been met. It is the sole responsibility of Contractor to correct any subsequent discoveries of inadequate initial cleaning, preparation, work procedures, or remaining ACM/ACCM encountered after an inspection, regardless of the outcome of such an inspection.

- I. Supervisory Personnel: Contractor must have an accredited Supervisor at each job site at all times, from mobilization to completion. Failure to have a Supervisor present shall result in termination of all asbestos abatement activities for the remainder of the day, or until an accredited Supervisor is again present. Contractor shall not begin work until an accredited Supervisor is present, and shall cease all work when Supervisor leaves the work site.
- J. Security of Containments: Contractor must secure all entrances to containments with a lockable plywood door. The door will be locked with a combination lock. The combination will be given to HazMat Project Manager and Owner's Security Representative. When decontamination units are located on the exterior of buildings, Contractor must cover the exterior portion of decontamination unit with 2" plywood, or suitable optional material to be approved by HazMat Project Manager and Owner.

## 1.2. SUBMITTALS, NOTICES, RECORDKEEPING, AND REFERENCES

### 1.2.1 Submittals

**Note: At a minimum, the contractor performing any and all work as part of this contract must have a California Contractors State License Board (CLSB) 'B' License Classification or a 'C' License Classification AND must have a CSLB C-22 License AND be a California Department of Industrial Relations, Division of Occupational Safety and Health (DOSH) registered contractor to perform any and all work as part of this contract. Copies of valid and current CSLB licenses and DOSH registration certificate are to be provided by the contractor as part of the pre-job submittal. Contractors having endorsements, riders or qualifiers on any of their licenses such as (but not limited to) 'for bidding purposes only' etc. are ineligible to perform work as part of this contract.**

- A. Submit the following to the HPM for approval within Ten (10) days of receiving the "Notice to Proceed" or at least Ten (10) Working Days prior to the start of work. These submittals are in addition to those required in any other section(s) or sub-section(s) of these documents. This document shall be submitted by the contractor performing the work and not by any other. Include at the very least the following:
  - 1. Notifications. All notifications shall be current and valid throughout the duration of the project. Any material changes to the notification, i.e., the quantity of materials being removed, the physical materials being removed, the duration of the project, etc. shall require revisions to the regulatory agencies, with copies provided to the HPM on site. Copies of the written notification and confirmations at least to/from the following regulatory agencies will be required:
    - a. Regional EPA and/or the local Air Quality Management District;
    - b. California Division of Occupational Safety and Health (Cal-OSHA) - Temporary Worksite Notification for Asbestos and Methylenedianiline-related work;
    - c. Air Resources Board Office (*if 1a above is not applicable*);
    - d. Local Authority charged with the responsibility for the enforcement of Occupational Health & Safety, if any (*if 1b above is not applicable*);
    - e. Any other agency as and when necessitated by prevailing regulation(s).
  - 2. Waste Haulers – Copies of :
    - a. Identification of the Waste Hauler(s) for both Hazardous and Non-Hazardous asbestos waste for this Project;
    - b. California Department of Toxic Substances Control (or DTSC) Hazardous Waste Transporter registration for each Waste Hauler;
    - c. California Department of Motor Vehicles (DMV) Motor Carrier Permit for each Waste Hauler;
    - d. U.S. Department of Transportation (DOT) Registration and U.S. Environmental Protection Agency (EPA) acknowledgement of Notification of Hazardous Waste Activity for each Waste Hauler (*only required if waste is to be transported out of State*);
    - e. Statement indicating that all waste generated on this specific site shall be transported by/disposed of by

- licensed, insured and certified personnel/locations;
- f. Statement that the types of Waste Containers being used for this Project will be accepted by the Waste Hauler(s) for the storage and transport of both Hazardous and Non-Hazardous waste.
3. Landfills – Copies of :
- Identification of the Landfill(s) to be used for the disposal of both hazardous and non-hazardous asbestos containing waste generated at the Project site;
  - Permits for the Landfill(s) to be used for the disposal of both hazardous and non-hazardous asbestos waste generated at the Project site;
  - Identification of the Types of Waste accepted at the Landfill(s);
  - Identification of the Types of Waste Profiling required by the Landfill(s);
  - Statement that the types of Waste Containers being used for this Project will be accepted by the Landfill(s) for both hazardous and non-hazardous waste.
4. Licensure:
- Copy of the current California Contractors State Board (CSLB) License (minimum requirement is a Class B License or a Class C License AND a CSLB C-22 License) for any and all contractor(s) or sub-contractor(s) involved in any facet of asbestos related work enumerated as part of this project;
  - Copy of the registration with the Division of Occupational Safety and Health, (Cal/OSHA) endorsement for Asbestos (ASB) work for any and all contractor(s) or sub-contractor(s) involved in any facet of asbestos related work enumerated as part of this project;  
NOTE: Contractors having endorsements, riders or qualifiers on any of their licenses such as (but not limited to) 'for bidding purposes only' etc. are ineligible to perform work as part of this contract.
5. Work Plan. A detailed written asbestos work plan including, but not limited to, the following:
- Identification of all Asbestos Scope of Work items that are part of this Project.
  - Identification of entire Work Sequence (schedule) for this Project, including specifics of materials being removed/stabilized and the correlation between work areas and Types of Work (Asbestos, Lead, PCB, etc. as applicable).
  - Identification of abatement duration.
  - Identification of dust control measures.
  - Identification of work area preparation.
  - Identification of construction of decontamination enclosure systems.
  - Identification of demarcation protocols. i.e., installation of barrier tape, barrier fence, asbestos signage, etc.
  - Identification of work area isolation protocols.
  - Identification of Site specific asbestos containing materials removal procedures.
  - Identification of asbestos-containing/contaminated debris cleanup and disposal procedures.
  - Identification of personal protection equipment to be utilized.
  - Identification of waste handling, storage and disposal procedures.
  - Identification of construction of chutes, if required for this project.
6. HEPA Vacuums, HEPA Differential Pressure Unit air filtration devices, HEPA Filters and other local exhaust ventilation equipment. – Copies of :
- Manufacturer's certification that any and all HEPA Vacuums, HEPA Differential Pressure Unit air filtration devices, HEPA Filters and other local exhaust ventilation equipment to be used on this Project conform to ANSI Z9.2-79.
  - Notification that required onsite testing has been scheduled for any and all HEPA Vacuums, HEPA Differential Pressure Unit air filtration devices, etc., to be used on this Project, to ensure that the filtration efficiency meets the criteria for HEPA filtration devices, i.e., 99.97% efficiency at arresting mono-dispersed particulate matter greater than 0.03 micrometers in diameter.

7. SDS– The Contractor shall submit copies of the Safety Data Sheet, fire retardant certification or equivalent, in accordance with the OSHA Hazard Communication Standard (29 CFR 1910.1200) for each surfactant, encapsulating material, spray glue, mastic removal agent, plastic sheeting, adhesive/duct tape, etc. or other chemicals/products for use on this Project, including the specific worker protective equipment proposed for use with the material indicated.
8. Personnel Documentation – Copies of :
  - a. Identification of the Project’s Asbestos Related Demolition Supervisor/Competent Person who meets the requirements of 29 CFR Part 1926.1101 and 8 CCR Part 1529 and is experienced in administration and supervision of asbestos abatement projects, including work practices, protective measures for building and personnel, disposal procedures, etc.
  - b. Current and complete documentation that the Contractor’s employees performing asbestos removal, disposal, etc., operations have received training which meets the criteria of Federal EPA Model Accreditation Plan (40 CFR Part 763, Subpart E, Appendix C). Training certification shall be provided prior to the start of work involving asbestos abatement, for all of the Contractor’s workers, forepersons, and Asbestos-Related Demolition Supervisors/Competent Persons. Training shall meet the requirements of 29 CFR Part 1926.1101 and 8 CCR Part 1529 and the criteria of the Federal EPA Model Accreditation Plan (40 CFR Part 763, Subpart E, Appendix C). Training shall be provided prior to the time of job assignment and, at least, annually. Training will be in compliance with all current Cal/OSHA requirements.
  - c. Provide as part of the pre-job submittal a letter from the contractor, signed by a responsible and authorized officer of the contractor’s company certifying the following – “This is to certify that all our personnel who may be exposed to airborne asbestos fibers are subject to current and valid medical monitoring in accordance with 29 CFR Part 1926.1101 and 8 CCR Part 1529 and they will receive continued medical surveillance, including monitoring their ability to work while wearing required respiratory protection without suffering adverse health affects as required by 29 CFR Part 1926.1101 and 8 CCR Part 1529 and by state and local regulations pertaining to such work. Furthermore, we certify that all relevant records shall remain valid and current throughout the project and that historical records will be retained by us, in accordance with 29 CFR Part 1926.1101.” The contractor may issue this letter and identify and list (by name) all of their employees who will be on site for this project or, alternatively issue an individual letter per employee.
  - d. Current and complete documentation of respirator fit-testing for Contractor employees and agents who must enter the work area. This fit-testing shall be in accordance with qualitative procedures as required by OSHA regulations or be quantitative in nature.
9. Respirators and Filters – Copies of Manufacturer’s documentation and certification of NIOSH approvals for respiratory protective devices utilized on site, including manufacturer’s certification of NIOSH approval of respirator cartridges (organic vapor, acid gas, mist, dust, high efficiency particulate) and High Efficiency Particulate Air (HEPA) filtration capabilities for all cartridges and filters.
10. Testing Laboratory. Submit the name, address and telephone number of the testing laboratory selected for analyzing personal air monitoring filters along with copies of certification that persons counting the samples have successfully completed NIOSH course #582 or a proven equivalent, that the lab has been judged proficient by successful participation in the National Institute for Occupational Safety and Health (NIOSH) Proficiency Analytical Testing (PAT) Program.
- 11 Site Specific Documentation – Copies of :
  - a. Identification of Work Area(s) at the site;
  - b. Identification of the nearest medical facility and route map/directions to the medical facility;
  - c. Emergency Contact Information and numbers for Emergency services as well as the contractors’ emergency contact personnel and information;
  - d. Identification of on-site emergency meeting location;
  - e. Identification and procedure for personnel accounting during an emergency.

12. Contractor General Documents – Copies of :
  - a. General Injury & Illness Prevention Program in compliance with 26 CCR 3203.
  - b. General Emergency Action Plan in compliance with 26 CCR 3220.
  - c. General Fire Prevention Plan in compliance with 26 CCR 3221
  - d. Respiratory Protection Program in compliance with 26 CCR 5144
  
- B. Hazardous waste manifests, non-hazardous waste data forms, trip tickets and disposal receipts for asbestos waste materials removed from the work area must be received within 24 hours of the transport
  
- C. Documents to be Provided on-site throughout the duration of the project:
  1. Provide on a DAILY basis, prior to the start of the shift, results from the personal air samples collected during the abatement process of the prior shift.
  2. Provide on a DAILY basis, prior to the start of the shift, copies of the containment entry log pertaining to the abatement process of the prior shift.
  3. Provide on a DAILY basis, prior to the start of the shift, copies of the Manometer logs pertaining to the abatement process of the prior shift.
  4. Copies of Safety Data Sheet (SDS) for solvents, encapsulants, wetting agents, neutralizers and any other chemicals/products used on site and replacement materials, as necessary.
  
- D. Upon completion of all asbestos abatement activities, submit to the HPM, documentation that includes, without limitation, the following:
  1. Work area entry/exit logbook. The logbook must record the name, affiliation, time in, and time out for each entry into the work site;
  2. Safety Data Sheet (SDS) for solvents, encapsulant(s), wetting agents and replacement materials, as necessary;
  3. OSHA required personal air monitoring results;
  4. Accident/incident reports where injury or damage has occurred on or to the client's property, if any;
  5. Safety Meeting Records;
  6. Daily Reports and Containment Manometer Log(s);
  7. Personnel documents for any and all personnel on site at anytime during the project

### 1.2.2 Notices to Contractor

The following section contains general notices applicable to Contractor for all asbestos abatement work for Owner.

- A. Employee Behavior
  1. All contractor employees shall be freshly shaved on a daily basis prior to the commencement of each work shift. The Hazmat Project Manager can direct the shift supervisor to have any and all employees removed from the work site if the Hazmat Project Manager determines that employees' facial hair may impede an adequate respirator seal.
  2. Contractor must provide its employees with a written policy of drug and alcohol abuse. No employee of Contractor shall be allowed to remain on Owner's property who is intoxicated by drugs (substance abuse) and/or alcohol, or who is observed using drugs or alcohol on Owner's property.
  3. Contractor is expected to enforce its drug and alcohol abuse policy at all times while conducting business.
  4. Weapons and other hazardous, dangerous, or otherwise disruptive items in the possession of Contractor or its employees are not allowed on Owner's property.

5. Contractor and its employees are required to display good manners to building staff and occupants at all times while on Owner's property. Complaints to HazMat Project Manager or Owner regarding harassment, threatening behavior, poor personal hygiene, or use of profanity or offensive language by any employee of Contractor may result in the suspension of abatement activities until the behavior problem is corrected or employee is removed from owner's property.
- B. Performance Standards:  
Contractor shall perform all asbestos removal using techniques and procedures recognized by the asbestos removal industry as being safe and effective in the control of fiber release during removal of ACM/ACCM. Contractor is expected to perform all removal, cleaning, and disposal operations in a manner that would meet final air clearance standards for analysis by Transmission Electron Microscope (TEM).
- C. Pay Requests: All requests for payment by Contractor must be submitted to the owner directly..
- D. Analytical and Test Results
1. Results of bulk sample analyses of ACM/ACCM pertaining to the scope of the asbestos abatement projects are available from Owner or HazMat Project Manager at Contractor's request.
  2. Results of background and previous air monitoring tests made by HazMat Project Manager prior to commencement of work will be available from HazMat Project Manager upon request prior to the beginning of asbestos removal project.
  3. Results of final air tests analyzed by phase contrast microscopy (PCM) will be made available to Contractor within, at least, 24 hours of collection of the sample. Results of final air tests analyzed by transmission electron microscopy (TEM) will be made available within, at least, 48 hours of completion of collection of the sample. HazMat Project Manager will make every reasonable effort to obtain these test results in a time and manner suitable to Contractor's work schedule.
- E. Condition of Building and Fixtures:  
Contractor and HazMat Project Manager shall agree in writing on the condition of the building and fixtures, prior to commencement of work. A report on the "Condition of Building and Fixtures" must be signed and notarized by both Contractor and HazMat Project Manager prior to commencement of asbestos abatement. Damages incurred by Contractor must be repaired and/or damaged materials replaced at Contractor's expense.
- F. Royalties and Patents:  
All fees, royalties, and claims for any invention, or pretended invention, or patent on any article, material, arrangement, appliance or method that may be used upon or in any manner be connected with the construction of this work or appurtenances are hereby included in the prices stipulated in this contract for said work; Contractor hereby expressly binds himself or itself to indemnify and save harmless Owner from all such claims, fees, and from any and all suits and actions of every name and description that may be brought against Owner on account of any such claims, fees, royalties, or costs for any such invention or patent, and from any and all suits or actions that may be brought against Owner for the infringement of any and all patents or patent rights claimed by any person, firm or corporation.
- G. Indemnification:  
Contractor agrees to indemnify, defend, save and hold harmless Owner from all claims, demands, liabilities, and suits of any nature whatsoever to the extent they arise out of, or are due to the negligent or wrongful act or omission by Contractor or its employees.



### 1.2.3 Record keeping

- A. For each building where ACM/ACCM has been removed, all records concerning removal of asbestos-containing materials shall be kept and a copy of these records given to HazMat Project Manager at the completion of the asbestos removal project. HazMat Project Manager shall submit all documentation to Owner.
- B. For each specific asbestos removal project, Contractor shall provide HazMat Project Manager with a written description of the asbestos removal measure that shall include:
  - 1. Methods used
  - 2. Location of removal project
  - 3. Start and completion dates
  - 4. Names and addresses of all contractors (and subcontractors) involved in the activity
  - 5. State Asbestos Abatement License number
  - 6. The name and location of the disposal site
- C. Furnish to HazMat Project Manager a copy of training records for each person used by Contractor that shall include:
  - 1. The person's name and job title
  - 2. Date of completion of training
  - 3. Location of the training
  - 4. Number of hours of training
- D. For each asbestos removal project, the name, signature, State of accreditation, and accreditation number of each person performing the removal shall be recorded and given to HazMat Project Manager.
- E. For each asbestos abatement project performed for Owner, Contractor shall certify that all asbestos-containing materials related to the scope-of-work have been removed and disposed of in accordance with all applicable federal, regional, state, and local regulations for asbestos abatement.

## 1.2.4 Applicable Reference Documents

The most recent issue of each document is applicable. In case of overlapping jurisdiction of documents or regulations, the most stringent requirements are applicable.

### Applicable Regulations

#### CODE OF FEDERAL REGULATIONS (CFR)

29 CFR 1910	Occupational Safety and Health Standards for General Industry
29 CFR 1926	OSHA Construction Standards
29 CFR 1926.1101	Construction Standard for Asbestos, Tremolite, Anthophyllite & Actinolite

#### U.S. ENVIRONMENTAL PROTECTION AGENCY (EPA)

40 CFR 61 Subpart A & B	General Provisions
40 CFR 61 Subpart M,	National Emission Standards for Hazardous Air Pollutants (NESHAP)
40 CFR 241	Guidelines for the Land Disposal of Solid Wastes
40 CFR 257	Criteria for Classification of Solid Waste Disposal Facilities & Practices
40 CFR 260	Hazardous Waste Management Systems: General
40 CFR 261	Identification & Listing of Hazardous Waste
40 CFR 262	Standards Applicable to Generators of Hazardous Waste
40 CFR 263	Standards Applicable to Transporters of Hazardous Waste
40 CFR 264	Standards for Owners of Hazardous Waste treatment, Storage & Disposal Facilities
40 CFR 265	Interim Status Standards for Owners of Hazardous Waste Treatment, Storage & Disposal Facilities
40 CFR 268	Land Disposal Restrictions
40 CFR 763	Asbestos-Containing Materials in Schools Rule (AHERA)
40 CRF 763 Subpart G	Worker Protection Rule

#### U.S. DEPARTMENT OF TRANSPORTATION (DOT)

49 CFR 171 & 172	Transportation of Hazardous Waste
------------------	-----------------------------------

#### AMERICAN NATIONAL STANDARDS INSTITUTE (ANSI) PUBLICATIONS

Z9.2-79	Fundamentals Governing the Design and Operation of Local Exhaust Systems
Z88.2-80	Practices for Respiratory Protection

#### UNDERWRITERS LABORATORIES, INC. (UL) PUBLICATIONS

586-77 (R 1982)	Standard for Test Performance of High-Efficiency Particulate Air Filter Units
-----------------	---

#### AMERICAN SOCIETY FOR TESTING AND MATERIALS (ASTM) PUBLICATIONS

D 4240	Guide for Evaluation of Encapsulants for Friable Asbestos and Building Materials
D 1331-56(R80)	Surface and Interfacial Tension of Solutions of Surface Active Agents

#### U.S. ENVIRONMENTAL PROTECTION AGENCY (EPA) PUBLICATIONS

EPA 560/5-85-024	Guidance for Controlling Asbestos-containing Materials in Buildings
------------------	---

CALIFORNIA CODE OF REGULATIONS (CCR) PUBLICATIONS

Title 8 CCR California Code of Regulations  
Title 22 Div 4 Chapter 30 Hazardous Waste Handling

**1.2.5 Warning Signs and Labels**

- A. Each disposal bag or waste container must be labeled with "Asbestos NA2212," the generator's name and location, and a class 9 label. Disposal bags shall be marked as follows:

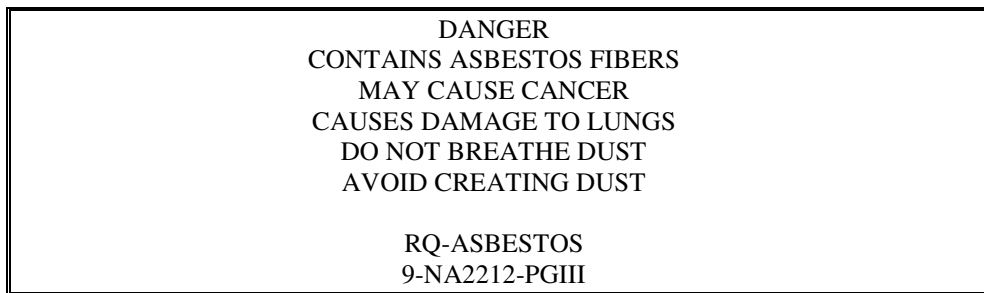

The transport container must have a Class 9 label with the asbestos ID number 2212 in an orange rectangular or white square on point display on all four sides of the container.

- B. Warning signs shall be posted at all entrances to the work area and shall be labeled as follows:

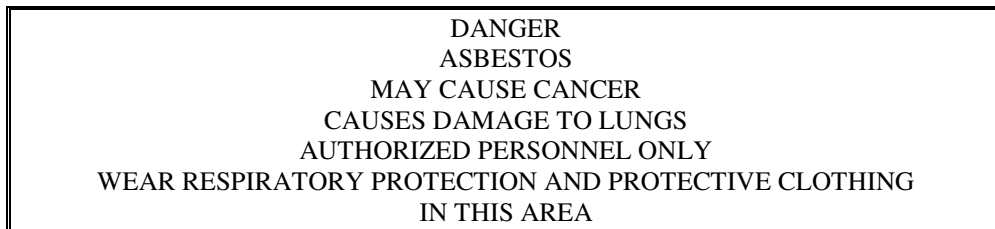

- C. Barrier tape (Caution Tape) shall be placed at all hallways and corridors that lead to the work area and will display the following:

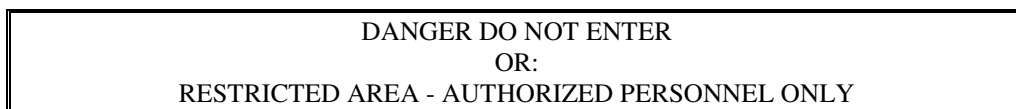

**1.3 EQUIPMENT REMOVAL, SITE SECURITY, AND SITE CONDITIONS**

**1.3.1 Equipment Removal Procedures**

Clean external surfaces of contaminated containers and equipment thoroughly by wet-cleaning with sponges, or use HEPA-filtered vacuum before moving such items into equipment decontamination unit washroom for final cleaning and removal to uncontaminated areas. Ensure that personnel do not leave work areas through equipment decontamination unit.

### 1.3.2 Site Security

- A. Contractor shall provide site security during the hours when Supervisor and workers are on site at no additional cost to Owner. During the hours when Contractor is not on site, Owner will specify the time period during which security shall be required. Contractor may, at Contractor's option, employ a security service, or use employees of Contractor. Owner may, at Owner's option, provide "off-time" site security.
- B. The entrance to the containment must be locked at all times that an employee of Contractor is not present at the entrance. If any windows and/or door are removed as a part of the work assigned to the contractor, it is the contractor's responsibility and at the contractor's expense to secure these areas with plywood (or other acceptable material) door/window covers with locking devices as may be necessary.
- C. When decontamination units are located on the exterior of buildings, Contractor must cover the exterior portion of decontamination unit with 2" plywood, or other suitable material to be approved by HazMat Project Manager and Owner.
- D. Contractor is responsible for all damages to the building or its contents or occupants that result from the operation of Contractor's equipment or personnel within the building, except when specified by HazMat Project Manager or his agent. Damages include, but are not limited to cleanup of any areas contaminated by Contractor during his work and all liquidated damages as stated and agreed to by Owner and Contractor as a result of Contractor's activities.

### 1.3.3 Site Conditions

- A. Facilities: Domestic power and access to water may not be made available for Contractor's use for the duration of each specific abatement project. If made available and when these utilities are inadequate, Contractor must supply additional utilities. It is the contractor's responsibility to supply power, water and worker sanitation facilities for accomplishing the specified work. The contractor is also responsible for supplying electricity for the monitoring and air clearance equipment utilized by the HazMat Project Manager throughout the duration of the project.
- B. Extent of initial cleaning: When HazMat Project Manager has determined that friable or damaged asbestos-containing materials have contaminated or potentially contaminated equipment and surfaces in the work area, all exposed surfaces in work area that will be protected by fire-retardant polyethylene sheeting shall be thoroughly cleaned with HEPA-filtered vacuums and wet-cleaned prior to installation of fire-retardant polyethylene sheeting over these surfaces.
- C. Equipment storage: Arrangement for equipment storage will be made during pre-construction meeting.
- D. Dumpster location: Arrangements for location of dumpsters to be made at pre-construction meeting. All dumpsters used on asbestos abatement projects for Owner must be secured with locks. Dumpsters must remain locked at all times while present on Owner's property, except when opened to receive waste. All debris boxes/dumpsters used on this project shall be hard sided including a hard lid, locked at all times when not in use and placed in an owner designated location.
- E. Contractor parking: Arrangements for Contractor employee parking to be made at the pre-construction meeting.

## 1.4 PERSONAL PROTECTION

### 1.4.1 Personal Protection

- A. Prior to commencement of work, the workers must be instructed, knowledgeable, and accredited by an EPA-approved training facility on the hazards of asbestos exposure, on the use and fitting of respirators, on protective clothing, and on all aspects of work practices and protective measures. This training must comply with all regulations applicable to worker training in the State of California, or State where the work will take place. All workers must have evidence of current accreditation in their possession, or I.D. cards issued by an EPA-approved training agency. Workers having expired accreditation certificates will not be allowed in work area.
- B. In accordance with 29 CFR 1926.150, Contractor shall supply fire extinguishers for use inside and outside the work area. Contractor shall ensure that all employees have been instructed in the general principles of fire extinguisher use and the hazards involved with incipient stage fire fighting.
- C. Respiratory Protection
1. All contractor employees shall be freshly shaved on a daily basis prior to the commencement of each work shift. The Hazmat Project Manager can direct the shift supervisor to have any and all employees removed from the work site if the Hazmat Project Manager determines that employees facial hair may impede an adequate respirator seal.
  2. Provide workers with personally issued and marked respiratory equipment approved by NIOSH and suitable for asbestos exposure level in work area.
  3. Half-mask, dual cartridge, air purifying respirators must be worn by all personnel during the preparation of work areas having friable ACM/ACCM. Respiratory protection will not be required for preparation of work areas having only non-friable ACM/ACCM (only if a negative exposure assessment for that activity has been determined). Workers may use respiratory protection when not required, if they so desire.  
A sufficient supply of respirator filters shall be maintained at the work site to provide new filters to employees, Owner Employees, authorized visitors, and government regulator personnel throughout the duration of the project. Filters shall be replaced according to the manufacturer's recommendations, when breathing becomes difficult, or if the filter becomes wet. At any time during on-site work activity, the contractor shall maintain on-site and readily accessible three (3) new respirators, one in each size, small, medium and large along with the requisite filters/cartridges for the type of work being performed. These respirators will be kept in readiness for the Owner/Owner's representative or any governmental agency representative having jurisdiction over the project. Additionally, the contractor shall make available to HPM two (2) sets of new North™ 7700 Series Respirator Filter Cartridges throughout the duration of the project. These filter cartridges shall be appropriate to the work being conducted on site i.e., P100 HEPA Cartridge and/or stacked P100 HEPA + Organic Vapor Cartridge, etc.
  4. If Contractor personnel intend to use a respirator less efficient than a Powered Air Purifying Respirator (PAPR) for removal of friable ACM/ACCM, Contractor must make available air testing results that show that fiber levels for similar work performed in the past were less than 0.1 fibers/cc. When fiber counts in excess of 0.1 fibers/cc are anticipated, PAPR or Type C pressure demand respiratory equipment will be the minimum required respiratory equipment.
  5. When respirators with disposable filters are employed, Contractor must provide sufficient replacement filters as required by the worker or applicable regulations.
  6. Contractor shall begin removal of friable surfacing or thermal insulation ACM/ACCM with all personnel in work area using PAPR or Type C supplied air respirators unless documentation is submitted to HazMat Project Manager that shows permissible levels of airborne fibers (1.0 fibers/cc or less) on similar jobs in the

past. HazMat Project Manager must approve all documentation in writing, before use of PAPR or Type C respirators can be waived.

7. Unless the Contractor can supply the HPM with acceptable historical personal air monitoring data collected within the last six (6) months for similar ACM (similar asbestos material, mineral composition and concentration), the material being removed utilizing similar techniques, by the same workers; all work under this project, shall commence with all workers utilizing, at a minimum, Powered Air Purifying Respirators (PAPR's). Once the site conditions, work practices and engineering controls being utilized have demonstrated to the satisfaction of the HazMat Project Manager that the average ambient fiber concentration inside the work area, collected over a minimum of two (2) consecutive work shifts, is less than 0.05 fibers per cubic centimeter of air, the HazMat Project Manager may permit the contractors personnel to downgrade to Half-face Negative Pressure Respirators.

In the event that subsequent air monitoring shows an increase in the ambient fiber concentration level at or above 0.05 fibers per cubic centimeter of air, the Hazmat Project Manager will require the use of PAPR's until the conditions listed above have been met.

The minimum respiratory protection throughout the project shall be Half-face Negative Pressure Respirators with a protection factor of ten (10) times the Permissible Exposure Limit.

#### D. Protective Clothing

1. All employees of Contractor, and authorized visitors are required to wear protective clothing while inside work areas. The protective clothing must be worn properly. No modifications to the clothing may be made that exposes the wearer's skin, other than the hands and face. Protective clothing is to include steel toe safety shoes or rubber boots as applicable, hard hats, eye protection, hearing protection and appropriate gloves.
2. Contractor must provide workers and authorized visitors with sufficient sets of protective full body clothing. Such clothing will consist of protective full body coveralls and headgear. Contractor must provide eye protection and hard hats to all employees and authorized visitors, when required by applicable safety regulations.
3. Non-disposable protective clothing and footwear must be left in equipment room until the completion of the asbestos abatement work. At this time, such items must be disposed of as ACM/ACCM, or must be thoroughly cleaned of all ACM/ACCM. Disposable protective clothing, headgear, and footwear may be provided.
4. The use of canvas or leather footwear is strictly prohibited in contaminated areas or work areas. All authorized personnel must wear rubber boots, or other approved footwear that is easily decontaminated. Footwear must be approved by HazMat Project Manager.

E. Provide and post, in equipment room and clean room, the decontamination procedures, work procedures, and personal protection procedures to be followed by workers, as described in these specifications.

F. Provide and post, in clean room, the a map and clearly marked route of the location of the nearest hospital, telephone, applicable emergency phone numbers, and any other emergency information and procedures for this work.

#### G. Worker Protection Procedures

1. Each worker and authorized visitor must, upon entering the job site: remove street clothing in clean room and put on a respirator with functional filters and clean protective clothing before entering equipment room or work area. Workers intending to re-wear contaminated protective clothing stored in equipment room must enter

equipment room wearing only respirators (workers will be permitted to wear tight-fitting, nylon swimsuits beneath their protective clothing).

2. Each worker and authorized visitor must, each time he leaves work area:
  - a. Remove gross contamination from clothing with a HEPA-filtered vacuum before leaving work area.
  - b. Proceed to equipment room, remove all clothing except respirators and optional swimsuit, and proceed directly to shower room.
  - c. Wet the outside of the respirator with water while showering.
  - d. Remove the respirator and thoroughly shampoo and wash them.
  - e. If worker intends to change filters, remove filters, wet them, and dispose of them in the container provided for this purpose.
  - f. Wash and rinse the inside of the respirator.
3. After showering, each worker and authorized visitor must:
  - a. Proceed directly to clean room, dry off, and dress in uncontaminated street clothes at the end of each day's work, or before eating, smoking, or drinking.
  - b. Before re-entering work area from clean room, each worker and authorized visitor must put on a respirator equipped with functional filters and must dress in clean protective clothing.
4. Workers intending to re-wear contaminated protective clothing stored in equipment room must enter equipment room wearing only respirators and optional swimwear.
5. Workers removing waste containers from equipment decontamination unit must enter holding area from outside wearing a respirator and dressed in clean protective clothing. No worker shall use this unit as a means to leave or enter washroom or work area.
6. Workers must not eat, drink, smoke, chew gum or tobacco, or apply cosmetics at the worksite except outside the controlled area. Smoking will not be permitted in the School Buildings or on School Property at any time.

#### H. Type C Air Supplied System

When a Type C Supplied Air System is to be used, the following specifications apply:

1. Grade D Air: Compressed air must be at least Grade D quality. Certification of Grade D air quality must be supplied by an independent testing lab after the system has been installed on site.
2. Compression: When supplied air is required, compressors shall be used throughout removal project to generate the air supply. The following specifications apply to compressor procedures:
  - a. Compressor Shut Down: Interconnect monitors, alarms and compressor so that compressor is automatically shut down and the alarms sounded if any of the following occur:
    - 1) Carbon Monoxide (CO) concentrations exceed 5 ppm/v in the air line between the filter bank and backup air supply,
    - 2) Compressor temperature exceeds normal operating range.

- b. Compressor Location: Locate compressor in a location that will not impede access to the building and that will not cause a nuisance by virtue of noise, exhaust gases, or fumes to occupied portions of the building.
  - c. Air Intake: Locate air intake remotely from any source of automobile exhaust or any exhaust from motors or buildings.
3. Purification: Supplied air must be purified using the following system of equipment:
- a. Aftercooler
  - b. A coalescing filter
  - c. Two adsorption filters consisting of:
    - 1) A molecular sieve to remove water vapor
    - 2) An activated charcoal filter
  - d. A mechanical filter capable of removing particles greater than 10 microns in diameter.
  - e. A carbon monoxide monitor equipped with a visual and audible alarm.
4. Storage: Provisions must be made to store a volume of air sufficient for safe exit from work area in the event of compressor failure. Stored air may not be necessary when respirators are equipped with a HEPA egress filter. HEPA egress filters may be used for emergency egress only in asbestos abatement containments.
5. Delivery: The air supply system must deliver air at a pressure sufficient to meet the respirator manufacturer's flow requirements. Any air-line respirators chosen must be of the Positive Pressure, Pressure Demand type, and approved by NIOSH. No unapproved respirators may be used at any time. The maximum air-line length must not exceed 300 feet, and maximum inlet pressure at the mask must not exceed 125 psi.
- I. Protection from Heat Stress: In work areas where heat stress to workers is inevitable, such as roofs and hot mechanical rooms Contractor must provide adequate work breaks in cool areas outside work area, and/or body vests with ice pack inserts, depending on the site conditions.



**SUB-SECTION 2.0**  
**LABOR, MATERIALS, AND EQUIPMENT**

**2.1 MATERIALS**

- A. Contractor must furnish all labor, materials, equipment, and subcontractors necessary for removal and disposal of ACM in a manner consistent with these specifications. These materials include but are not limited to:
1. Plastic (Polyethylene) Sheeting: Provide 6-mil thickness or greater polyethylene sheeting as specified in sizes to minimize the frequency of joints. Fire retardant polyethylene sheeting is required.
  2. Tape: Provide two inch or wider duct tape capable of sealing joints of adjacent sheets of polyethylene and for attachment of polyethylene sheets to finished or unfinished surfaces of dissimilar materials. Duct tape shall be capable of adhering under both dry and wet conditions, including use of amended water.
  3. Spray Cement: Provide aerosol based spray cement specifically formulated to stick tenaciously to sheet polyethylene.
  4. Surfactant: Provide a 50 percent polyoxyethylene ether and 50 percent polyoxyethylene ester, or equivalent and mix with water to provide a concentration of one ounce surfactant to 5 gallons of water.
  5. Impermeable Containers: Provide impermeable containers suitable to receive and retain any asbestos-containing or contaminated materials until disposal at Disposal Site labeled in accordance with OSHA Regulation 29 CFR 1910.1101, DOT 49 CFR 171-177, Title 8 CCR and BAAQMD. Containers must be both air and watertight and must be resistant to damage and rupture. Plastic bags shall be a minimum of 6-mil thick.
  6. Warning Labels and Signs: Provide warning labels and signs as required by OSHA Regulation 29 CFR Part 1910.1101, Title 8 CCR Part 1529 and the local air pollution agency, as required.
  7. Other Materials: Provide all other materials, such as lumber, nails and hardware, which may be required to construct and dismantle the decontamination area and the barriers that isolate the work area.
  8. Solvents used for the removal of resilient flooring mastics/adhesives shall be low-odor. Regardless of the solvent utilized, the contractor may have the waste profiled for RCRA composition by the HPM – all costs involved with this testing shall be borne directly by the contractor and not by the owner.
- B. Deliver all materials in the original packages, containers, or bundles bearing the name of the manufacturer and the brand name.
- C. Store all materials subject to damage off the ground, away from wet or damp surfaces, and under cover sufficient to prevent damage or contamination.
- D. Damaged or deteriorated materials shall not be used and must be removed from the premises. Material that becomes contaminated with asbestos must be disposed of in accordance with the applicable regulations.

## 2.2 TOOLS AND EQUIPMENT

- A. Provide suitable tools for asbestos removal, including but not limited to scrapers, brushes, razor knives, wrenches, tools for constructing containment and decontamination units, brooms, carts, and safety equipment.
- B. Provide suitable air moving and exhaust equipment, including but not limited to:
  - 1. A method for maintaining pressure differential of 0.02 inches of water column inside containment than outside.
  - 2. HEPA-filtered vacuums.
  - 3. Recording manometers for monitoring the pressure inside containment relative to outside
  - 4. Portable lighting and power supplies as necessary.
- C. No equipment shall cause suspension of ACM within work area or discharge of asbestos fibers outside of work area.
- D. Electricity, Water and Sanitation Facilities.

**ELECTRICITY, WATER AND SANITATION FACILITIES ARE THE CONTRACTORS' RESPONSIBILITY.** The owner may or may not provide electricity, water and sanitation (toilet) facilities at the owners discretion. It is the contractors' responsibility to furnish all power, water and sanitation requirement for the project. All costs associated with this are to be built in to the contractors base cost.

Additionally it is the contractors' duty and responsibility to provide the HPM with all their electricity requirements, in each work area, for the HPM to run their air sampling and other equipment. This supply of electricity is to be maintained uninterrupted for the entire duration of the project

## SUB-SECTION 3.0 EXECUTION

This section applies to the preparation, removal, cleanup, and disposal of asbestos-containing materials that are friable, non-friable, and mastic materials. Refer to SUB-SECTION 4.0 for SPECIAL PROCEDURES to be used for removal of exterior roofing materials, exterior asbestos cement panels, glove bag removal, mini-containment, and decontamination of contaminated areas.

### 3.1 PREPARATION

This part is intended to be used as a general specification for preparation of work area for any particular asbestos abatement project for Owner. Consult the Scope of Work for each individual building for more specific preparation requirements.

#### 3.1.1 General and Full Containment Procedures

Proper preparation of the work area prior to asbestos abatement is crucial. The general aspects of preparation of the work area, as required by Owner for this project are discussed below:

- A. **Critical Barriers:** All asbestos abatement work involving friable ACM/ACCM and non-friable ACM/ACCM shall require the installation of critical barriers at all penetrations to the work area. Any and all HVAC vents (supply or return) that are inside the work area shall be sealed with a minimum of two layers of 6-mil polyethylene and tape. Removable components of the HVAC system shall be removed, HEPA Vacuumed and wet wiped prior to being tagged and placed in 6-mil plastic bags and removed from the work area. Removed components shall be stored securely or handed over to the facility manager for eventual re-installation.
- B. **HVAC and Electrical Shut Down:** HVAC systems serving the work area must be either shut down or temporarily capped on all asbestos abatement projects. Electrical systems serving the work area shall be shut down and secured, or special provisions with Owner must be made to ensure the safety of abatement workers while asbestos abatement is performed. All electrical equipment used by Contractor in the work area must be protected by GFI circuits. The electrical supply to the work area must be located outside the containment. All electrical and HVAC system alterations or shut-downs shall be performed in conjunction with and at the direction of the owner, occupant and facility manager.
- C. **Pre-cleaning:** When The HazMat Project Manager has determined that friable or damaged asbestos-containing materials have contaminated or potentially contaminated equipment and surfaces in the work area, Contractor must HEPA vacuum and wet-wipe these items before application of protective covering.
- D. **Polyethylene Sheeting:** In general, all fixed objects and all (*architectural*) surfaces within (*in*) the work area must be protected from contamination during asbestos removal or from damage from application of encapsulants after asbestos removal. In certain instances, the HazMat Project Manager and Owner may not require a covering for walls, floors, or ceilings if the wall, floor, or ceiling material is smooth, non-porous, easily cleaned, and will not be aesthetically affected or damaged by application of amended water and encapsulants.
- E. **Pressure Differential:** All work areas must be placed under a pressure differential of at least minus 0.02 inches of water column, with respect to outside areas, prior to disturbance of asbestos-containing materials. The pressure differential equipment utilized shall be, at a minimum, capable of performing four (4) complete air exchanges per hour. For the purposes of this project, each pressure differential unit shall be evaluated at 75% of the manufacturers rated capacity. For example, if the manufacturers rated capacity for a differential pressure unit is 2,000 cfm., for the purpose of this project, that particular unit will be evaluated as having a maximum capacity of 1,500 cfm. The contractor shall provided the necessary equipment to maintain the required minus 0.02 inches of water column PLUS 20% additional equipment in the event of equipment malfunction work area changes, etc. The unused

equipment shall be tested, installed in the work area, sealed and kept in a state of readiness to be brought on line, if necessary, in a very short period of time.

### **3.1.2 Preparation for Asbestos Containing Materials / Asbestos Containing Construction Material (ACM/ACCM); Full Containment Procedures**

#### **A. Preparation**

1. Post warning signs and barrier tape in and around work area as required by all applicable regulatory agencies, and restrict access to work area to personnel approved by Contractor or The HazMat Project Manager.
2. Shut down electric power when necessary. Provide temporary power and lighting and ensure safe installation of temporary power sources and equipment per applicable electric code requirements. Use ground-fault interrupter circuits (GFIC) at all temporary power sources in work area. Locate power source for temporary power panels and electrical equipment outside work area. All modifications to the electrical power systems must be performed by a licensed electrician. Additional precautions shall be taken when enclosing live electrical panels or circuit breaker boxes. A rigid enclosure shall be built around the panels and covered with 6-mil plastic with a minimum of 12 inches of clearance or as indicated on the panel. This enclosure shall be kept under positive pressure using a HEPA filter equipped device (i.e., vacuum, differential pressure machine, etc.) to keep the panel adequately ventilated. All electrical panels or breaker boxes inside the work area shall be accessible to the workers within the area and access to them shall not be blocked or restricted. The location and usage of these panels shall form a part of the contractors' emergency plan and shall also be discussed as a part of the periodic site safety meeting. All electrical equipment used within the containment shall be routed through ground-fault interrupter circuits (GFIC).
3. Shut down and isolate heating, cooling and ventilating air systems to prevent contamination and fiber dispersal to other areas of the structure. During the work, vents within work area must be sealed with, at least, tape and fire-retardant polyethylene sheeting, unless otherwise indicated in the Scope of Work.
4. Clean supply and return air grilles, remove filters and dispose of filters as ACM.
5. Clean moveable objects and carpeting within the proposed work areas using HEPA-filtered vacuums and/or wet-cleaning methods as appropriate, and remove such objects from work area to a suitable temporary location.
6. Clean fixed objects within the proposed work area using HEPA-filtered vacuums and/or wet-cleaning methods as appropriate, and enclose objects with 6 mil fire-retardant polyethylene sheeting sealed with tape.
7. Clean proposed work areas using HEPA-filtered vacuums or wet-cleaning methods as appropriate. Methods that raise dust, such as dry sweeping or vacuuming with equipment not equipped with HEPA filters must not be used.
8. Seal off all openings, including but not limited to: corridors, doorways, elevators, skylights, ducts, grills, diffusers, and any other penetrations of work areas. Doorways and corridors that will not be used for passage during work must be sealed with critical barriers. These seals must be left in place until final air testing is complete and the results received and approved. The work area may require isolation from occupied areas of the building as determined by the owner and/or the HazMat Project Manager. This isolation may include the construction of rigid or "hard barriers".  
"Hard barriers" shall be constructed of wood or metal framing to support barriers in all openings larger than 4 feet by 8 feet. Plywood or drywall sheets shall be affixed to the work side of the barrier. The work area side of the hard barrier shall be covered with a double layer of 6-mil plastic sheeting sealed in place. The other side of the hard barrier shall be covered with a single layer of 6-mil plastic sheeting sealed at the ceiling, walls and floor level. The entire barrier shall be airtight and may be require a "smoke test" to confirm its integrity. Allowances must be made for emergency exits.

9. Cover surfaces in the proposed work area, which do not require asbestos removal, with fire-retardant polyethylene sheeting in the following manner:
  - a. Cover walls or erect temporary walls with 2 layers of (4-mil minimum thickness) fire-retardant polyethylene sheeting sealed with tape. This sheeting must be secured by staples and tension nails as necessary to maintain the integrity of containment throughout removal and testing process. The two layers of fire-retardant polyethylene sheeting must be placed so the upper layer can be removed without damaging the integrity of the lower layer.
  - b. Cover floors with 2 layers of (6-mil minimum thickness) fire-retardant polyethylene sheeting sealed with tape, when appropriate. The floor covering must extend at least 12" up the wall to contain leakage. The wall covering must overlap the floor covering.
  - c. Cover ceilings or erect temporary ceilings with 2 layers of (4-mil minimum thickness) fire-retardant polyethylene sheeting, sealed with tape, when appropriate. This sheeting must be secured in a manner that shall maintain the integrity of containment throughout removal and testing.
  - d. For work areas that do not have an adequately flat surface, or have extensive mechanical and/or electrical fixtures attached to the ceiling, Contractor shall perform initial cleaning of the exposed surfaces at the ceiling prior to removal, and perform wet-cleaning and HEPA-vacuuming during final cleanup. The ceiling area shall be encapsulated prior to final air testing.
10. Cover, isolate, or remove and clean ceiling-mounted objects, such as lights and other items not previously sealed off, or covered, that interfere with asbestos abatement. Use localized water spraying or HEPA-filtered vacuums during fixture removal to reduce fiber dispersal.
11. Maintain marked emergency and fire exits from work areas, or establish alternative exits satisfactory to the fire code.
12. Adequate illumination for the entire work area shall be provided for the entire duration of the project, during the working hours of the project shall be maintained until final clearance results are obtained.
13. The Contractor shall secure all windows and access points to the work area to prevent against break-ins and vandalism.
14. Two (2) Activated Charcoal Filters shall be used on each differential pressure units in the work area. The first of the two Activated Charcoal Filters shall be placed between the pre-filter and the secondary filter on the machine. The second Activated Carbon Filters shall be similar to the secondary air filters employed on the differential pressure units and shall be placed between units' secondary filter and the HEPA filter. All pre-filters, secondary filters and Activated Charcoal Filters shall be replaced on site prior to the commencement of any on-site filter/unit challenge testing.
15. Provide a minimum of two (2) easily accessible view ports to each work area. The view ports shall be a minimum of 18" x 18" clear, see-through plastic or plexiglass with no scratches, tape or glue marks that would impede viewing of the work area from an uncontained area. The contractor shall refer to the owner and/or the on-site the HazMat Project Manager for the location of the view ports. It may be necessary for the contractor to provide additional view ports to ensure that all sections of the work area are visible from an uncontaminated area at all times.
16. Seal all unused elevator doors on floors where work is in progress with fire-retardant polyethylene sheeting and plywood.

B. Decontamination Units

1. Use pre-constructed decontamination units or build suitable framing and line with double layer of fire-retardant polyethylene sheeting sealed with tape at all lap joints in the fire-retardant polyethylene sheeting for all containments and decontamination unit rooms.
2. Construct a worker decontamination unit contiguous to work area consisting of three totally enclosed rooms as follows:
  - a. An equipment room with two curtained doorways, one to work area and one to shower room.
  - b. A shower room with two curtained doorways, one to equipment room and one to clean room. Shower room must contain at least one shower with hot and cold water for each 10 persons in the work area. Water must be mixed at point of use (29 CFR 1910.141).
    - 1) Careful attention must be paid to shower room to insure against leaking of any kind and to insure proper drainage of shower water. There must be no standing water in the shower stall or shower room. Insure a supply of soap, shampoo and clean disposable towels at all times in shower room.
    - 2) Waste water must be filtered through a medium that is capable of removing suspended particles of a diameter greater than or equal to 3 microns. Filtered waste water must be discharged into public sanitary sewer systems. Discharge of filtered water onto surface soil, asphalt, concrete, or any other porous surface shall not be permitted.
    - 3) Permits from local state and federal government agencies, the local water pollution control district, public sanitary sewer entity, etc. will be required on site prior to any filtered waste water being discharged from the work area or the decontamination unit's shower system. Under no circumstances shall waste water (filtered or otherwise) be discharged into a storm water drain or runoff.
    - 4) Filtration devices' filter element or accumulation tank contents shall be removed, manifested and disposed off as friable Asbestos Containing Material at the contractors' expense.
  - c. A clean room with one curtained doorway into shower room and one entrance or exit to non-contaminated areas of the building. Clean room must have sufficient space for storage of the workers street clothes, towels, and other non-contaminated items.
1. When required or directed to by the owner and/or the HazMat Project Manager, provide or construct an equipment decontamination unit consisting of two totally enclosed rooms as follows:
  - a. A washroom, consisting of an airlock, with a curtained doorway to a designated area of work area and a curtained doorway to holding area.
  - b. A holding area, consisting of an airlock, with a curtained doorway to an uncontaminated area.
  - c. When the uncontaminated area is an elevator, a lockable plywood door must also be constructed and placed in front of the elevator door to restrict access to the contaminated areas.
  - d. Worker decontamination unit may be used as an equipment decontamination unit when deemed appropriate by the HazMat Project Manager.

C. Establish Pressure Differential and Ventilation

1. Install HEPA-filtered differential pressure unit in work area to lower concentration of airborne fibers in work area and contain airborne fibers. All differential pressure units shall be challenge tested on site to verify the efficiency of the HEPA Filtration Units to ensure that the units are filtering at a minimum of 99.97% efficiency for mono-dispersed particulate 0.3 micrometers in diameter. Challenge testing shall be performed using DOP or equivalent by persons conversant and experienced in the usage and testing of HEPA filtration units. Testing certificates shall be presented on site to the HazMat Project Manager or affixed to the machines. No differential pressure unit or other HEPA filter equipped equipment shall be used on site until and unless it has been tested and passed this challenge test.
2. All work areas must be placed under a pressure differential of at least minus 0.02 inches of water column, with respect to outside areas, prior to disturbance of asbestos-containing materials. The pressure differential equipment utilized shall be, at a minimum, capable of performing four (4) complete air exchanges per hour. For the purposes of this project, each pressure differential unit shall be evaluated at 75% of the manufacturers rated capacity. For example, if the manufacturers rated capacity for a differential pressure unit is 2,000 cfm., for the purpose of this project, that particular unit will be evaluated as having a maximum capacity of 1,500 cfm. The contractor shall provided the necessary equipment to maintain the required minus 0.02 inches of water column PLUS 20% (or a minimum of one machine – which ever is greater) additional equipment in the event of equipment malfunction work area changes, etc. The unused equipment shall be tested, installed in the work area, sealed and kept in a state of readiness to be brought on line, if necessary, at very short notice.
3. Locate HEPA-filtered exhaust units so that make-up air enters work area through decontamination unit, or other suitable source of make-up air. Place HEPA-filtered exhaust units as far as possible from the entrance/exit or other make-up air sources.
4. Exhaust ducts shall be attached plywood cut-outs and placed through opening window, door, or wall, then sealed with tape and vented to the outside of the building. Exhausts ducts shall not be placed adjacent to ventilation or HVAC units. The plywood cut-outs shall be attached to the building securely to prevent entry, theft or vandalism to the owners' property.
5. Start HEPA-filtered exhaust units prior to removal and continue operating continuously until final air clearance of work area has been successfully obtained.
6. Replace air filters in HEPA-filtered exhaust unit when the unit's manometer indicates that a pressure drop across the filters exceeds 1.0 inch of water, replace pre-filter first, then the secondary filter and finally the HEPA filter.
7. HEPA-filtered exhaust units will be inspected daily by The HazMat Project Manager to ensure proper maintenance, and correct placement of filters. The inspection results will be noted in the HazMat Project Manager's daily logs.
8. Pressure differential recorders (manometers) equipped with an acceptable method of self-recording, i.e., circular recorders, strip charts, print-out, etc. are required in each work area to monitor the pressure difference between the work area and the ambient conditions in the surrounding areas. The recording system shall be accurate to the nearest 0.001 inches of water column differential and be equipped with a functioning audible alarm that sounds if the difference becomes less than minus 0.020-inches water column. The recorders must be calibrated prior to their use and re-calibrated on a daily basis prior to the commencement of the work shift. The daily record produced by the machine is to be marked with the project name, location, date, and time handed over to the HazMat Project Manager or the owners' on-site representative at the conclusion of each work shift.
9. When pressure differential system is shut down at the end of the project, the filters must be left in HEPA-filtered exhaust unit and HEPA-filtered vacuums, and openings on these items must be sealed with polyethylene sheeting and duct tape. Exhaust tubes and vacuum tubes for the HEPA-filtered must be sealed with duct tape in

double bags or 2 layers of fire-retardant polyethylene sheeting. Filters on these pieces of equipment must not be replaced after final cleanup is complete to avoid any risk of re-contaminating the area.

D. Separation of Work Areas from Occupied Areas

1. Maintenance of Containment:

- a. Ensure that barriers and fire-retardant polyethylene sheeting are effectively sealed and taped. Repair damaged barriers and sheeting, and remedy defects immediately upon discovery. Maintenance is to continue until clearance to dismantle containment is given by The HazMat Project Manager.
- b. Supervisor shall frequently inspect containment during each work shift. Any breaks, breaches, delamination of plastic sheeting, etc., shall be repaired instantly.
- c. Monitor effectiveness of barriers with recording manometer. A pressure differential must be maintained at all times, prior to the first disturbance of ACM/ACCM and ending only when final air testing results show that fiber concentrations are acceptable by whichever method has been specified in the SCOPE OF WORK for final air clearance. In the event that pressure differential falls below minus 0.020-inches water column all removal activity in the work area shall cease and the contractor shall devote all resources to tracing and rectifying the fall in pressure prior. Removal shall be suspended until minus 0.020-inches water pressure is restored and permission has been obtained from the HazMat Project Manager to recommence the removal. While pressure is being restored the contractor shall direct that accumulated waste in the work area be bagged and the work area be cleaned.

2. Asbestos abatement work shall not be permitted until:

- a. Documentation for all on-site supervisors and workers has been submitted to, reviewed and accepted by the HazMat Project Manager. Supervisor and worker documents include current training certification(s), current medical surveillance certification and current respirator fit-testing certification. One copy of each of the aforementioned documents is to be submitted to the on site the HazMat Project Manager or their representative along with a copy of the notification to Cal/OSHA and the local air pollution control district, if required. A second copy is to be maintained on-site by the supervisor. It is the supervisors' responsibility to maintain current on-site documentation for all personnel substitutions or alterations.
- b. **All HEPA filter equipped differential pressure units and vacuum cleaners have been challenge tested and passed on site and are certified for use.** Di (2-ethylhexyl) phthalate (DOP, DEHP) POLY-ALPHA OLEFIN (PAO) or an equivalent challenge agent must be used to certify all HEPA filter equipped units.
- c. Arrangements have been made for the transportation and disposal of waste at the selected and approved landfill, as identified in Contractor submittals.
- d. Arrangements have been made to contain, filter or properly dispose of contaminated waste water. Permits from local state and federal government agencies, the local water pollution control district, public sanitary sewer entity, etc. will be required on site prior to any filtered waste water being discharged from the work area or the decontamination unit's shower system. Under no circumstances shall water (filtered or otherwise) be discharged into a storm water drain or runoff.  
Waste water must be filtered through a medium that is capable of removing suspended particles of a diameter greater than or equal to 3 microns. Filtered waste water must be discharged into public sanitary sewer systems. Discharge of filtered water onto surface soil, asphalt, concrete, or any other porous surface shall not be permitted.
- e. Decontamination units are in place and the work area is effectively isolated from the remainder of the building.



- f. All other preparatory steps have been taken and applicable notices posted and permits obtained.
- g. Only when all the above conditions have been met will Contractor be allowed to begin the disturbance of any ACM/ACCM. An inspection of each containment by the HazMat Project Manager will be performed prior to the start of removal. Removal shall not be performed until the condition of each containment is approved by the HazMat Project Manager.

### 3.2. ASBESTOS REMOVAL

This section is intended to be used as a general specification for asbestos removal in work area for any particular asbestos abatement project for Owner. Consult the Scope of Work for each individual building for more specific asbestos removal requirements.

Removal of Vinyl Floor Tile (or equivalent) and/or its associated adhesive/mastic shall be removed by manual means without the use of any electro-mechanical device unless the contractor can prove that it is operationally infeasible to remove the material(s) manually. Infeasible, in this instance, shall not include fiscal or schedule considerations.

- A. For the purposes of these specifications and for this project, the use of mechanical means for the removal of any materials, mastics or adhesives shall render the removal to be construed as that of a friable material. All containment, personnel protection, removal and disposal means, methods, local, state and federal regulations for friable materials removal shall be observed and adhered to. If solvents are used for the removal of mastics, adhesives, etc., in addition to the procedures enumerated herein, all of the solvent manufacturers procedures are also to be followed pertaining to transportation, storage, use, personal protective equipment requirements, disposal, etc. Solvents used shall be low-odor. All solvent waste material shall be placed in impervious barrels prior to being removed from the work area. In the event of a conflict between these specifications and those of the solvent manufacturer's, the more stringent shall apply. Depending on the chemical composition of the materials being removed, and the SDS of the solvent used, the ensuing amalgam of the solvent and the ACM/ACCM containing material may require disposal as a RCRA hazardous waste. Regardless of the solvent utilized, the contractor may have the waste profiled for RCRA composition by the HPM – all costs involved with this testing shall be borne directly by the contractor and not by the owner.

#### 3.2.1 Asbestos Removal, Friable Materials

- A. Prepare site as per section 3.1.1 and 3.1.2. In areas where ACM/ACCM is greater than 2" thick, wetting would begin the day before removal is to take place.
- B. The use of mechanical means for the removal of any material (including but not limited to putty, caulks, mastics, adhesives, etc.) shall render the removal to be construed as that of a friable material under this contact. All containment, personnel protection, removal and disposal means, methods, local, state and federal regulations for friable materials removal shall be observed and adhered to.
- C. Spray asbestos material with amended water using spray equipment capable of providing a mist application to reduce the release of fibers. Saturate friable material sufficiently to wet the substrate without causing excessive wetting, dripping, or delamination of the material.
- D. Spray the asbestos material repeatedly during removal process to maintain wet condition and minimize asbestos fiber dispersion. The spraying must not be used as a technique to remove or dislodge ACM/ACCM.
- E. Remove saturated asbestos material in small sections. As it is removed, the saturated asbestos material shall be packed in plastic bags of 6-mil minimum thickness and placed in appropriately labeled (29 CFR

1926.1101(k)(8)(iii)) container for transport. Fixtures designated for total demolition may be wrapped in double layers of 6-mil plastic, appropriately labeled and placed in labeled containers for transport. The Contractor shall adhere to disposal authorities' size and weight requirements for containers (bags or packages).

F. If solvents are used for the removal of mastics, adhesives, etc., in addition to the procedures enumerated herein, all of the solvent manufacturers procedures are also to be followed pertaining to transportation, storage, use, personal protective equipment requirements, disposal, etc. Solvents used shall be low-odor. All solvent waste material shall be placed in impervious barrels prior to being removed from the work area. In the event of a conflict between these specifications and those of the solvent manufacturer's, the more stringent shall apply. Depending on the chemical composition of the materials being removed, and the SDS of the solvent used, the ensuing amalgam of the solvent and the ACM/ACCM containing material may require disposal as a RCRA hazardous waste. Regardless of the solvent utilized, the contractor may have the waste profiled for RCRA composition by the HPM – all costs involved with this testing shall be borne directly by the contractor and not by the owner.

G. Waste Load-out Procedure

1. Seal bags or containers. Clean external surfaces of containers thoroughly by wet cleaning in the designated area of work area that is part of equipment decontamination unit.
2. Move containers to washroom, wet-clean each container thoroughly, and move to clean room area pending removal to uncontaminated areas. The material must be placed in a clean bag or container as it exits the equipment washroom and enters clean room area.
3. Ensure that containers are removed from clean room areas by workers who have entered from uncontaminated areas, dressed in clean coveralls. Ensure that workers do not enter from uncontaminated areas into washroom or work area. Ensure that contaminated workers do not exit work area through equipment decontamination unit.
4. When disposal bags are used, the bagged material must be placed within a second bag in the equipment decontamination unit. The second, outer bag must be labeled with all applicable warnings, including D.O.T. labeling. Double bagged material shall then be passed through clean room to a covered cart for removal from the building. When larger pieces of material are to be disposed of, the material must be wrapped in 2 layers of fire-retardant polyethylene sheeting and properly labeled in the equipment decontamination unit.
5. All bags, containers and drums must be tagged with the manifest number and the numbering system provided by Owner, if any.

F. Secondary Removal

2. After completion of gross removal work, all surfaces from which asbestos has been removed must be wet-brushed with a nylon or plastic brush and/or wet-cleaned by an equivalent method to remove all visible material. During this work the surfaces being cleaned must be kept wet.
3. The HazMat Project Manager will individually approve each area of encapsulation prior to commencement of encapsulation.
4. Encapsulant is to be applied only to surfaces from which ACM/ACCM has been removed and the HazMat Project Manager has approved off. Encapsulation is not to be construed as a method for sealing dust on surfaces.

### 3.2.2 Asbestos Removal, Non-friable Materials

- A. Prepare site as per section 3.1.1 and 3.1.2.
- B. Wet non-friable material with amended water and remove with appropriate equipment. Dispose of material according to waste load-out procedure.
- C. Spray the asbestos material repeatedly during removal process to maintain wet condition and minimize asbestos fiber dispersion. The spraying must not be used as a technique to remove or dislodge ACM/ACCM.
- D. Remove saturated asbestos material in small sections. As it is removed, the saturated asbestos material shall be packed in plastic bags of 6-mil minimum thickness and placed in appropriately labeled (29 CFR 1926.1101(k)(8)(iii)) container(s) for transport. Fixtures designated for total demolition may be wrapped in double layers of 6-mil plastic, appropriately labeled and placed in labeled containers for transport. The Contractor shall adhere to disposal authorities' size and weight requirements for containers (bags or packages).
- E. If solvents are used for the removal of mastics, adhesives, etc., in addition to the procedures enumerated herein, all of the solvent manufacturers procedures are also to be followed pertaining to transportation, storage, use, personal protective equipment requirements, disposal, etc. Solvents used shall be low-odor. All solvent waste material shall be placed in impervious barrels prior to being removed from the work area. In the event of a conflict between these specifications and those of the solvent manufacturer's, the more stringent shall apply. Depending on the chemical composition of the materials being removed, and the SDS of the solvent used, the ensuing amalgam of the solvent and the ACM/ACCM containing material may require disposal as a RCRA hazardous waste. Regardless of the solvent utilized, the contractor may have the waste profiled for RCRA composition by the HPM – all costs involved with this testing shall be borne directly by the contractor and not by the owner.
- F. Waste Load-out Procedure
  1. Seal bags or containers. Clean external surfaces of containers thoroughly by wet cleaning in the designated area of work area that is part of equipment decontamination unit.
  2. Move containers to washroom, wet-clean each container thoroughly, and move to clean room area pending removal to uncontaminated areas. The material must be placed in a clean bag or container as it exits the equipment washroom and enters clean room area.
  3. Ensure that containers are removed from clean room areas by workers who have entered from uncontaminated areas, dressed in clean coveralls. Ensure that workers do not enter from uncontaminated areas into washroom or work area. Ensure that contaminated workers do not exit work area through equipment decontamination unit.
  4. When disposal bags are used, the bagged material must be placed within a second bag in the equipment decontamination unit. The second, outer bag must be labeled with all applicable warnings, including D.O.T. labeling. Double bagged material shall then be passed through clean room to a covered cart for removal from the building. When larger pieces of material are to be disposed of, the material must be wrapped in 2 layers of fire-retardant polyethylene sheeting and properly labeled in the equipment decontamination unit.
  5. All bags, containers and drums must be tagged with the manifest number and the numbering system provided by Owner, if any.
- F. Secondary Removal
  1. After completion of gross removal work, all surfaces from which asbestos has been removed must be wet-brushed with a nylon or plastic brush and/or wet-cleaned by an equivalent method to remove all visible

material. During this work the surfaces being cleaned must be kept wet. After the area has been clean, it shall be vacuumed with a HEPA vacuum prior to the HazMat Project Manager being informed that the area is ready for a visual inspection.

2. The HazMat Project Manager will individually approve each area of encapsulation prior to commencement of encapsulation.
3. Encapsulant is to be applied only to surfaces from which ACM/ACCM has been removed and the HazMat Project Manager has approved off. Encapsulation is not to be construed as a method for sealing dust on surfaces.

### **3.3 CLEANUP**

This part is intended to be used as a general specification for cleanup of work area for any particular asbestos abatement project for Owner. Consult the Scope of Work for each individual building for more specific cleanup requirements.

#### **3.3.1 Cleanup**

- A. Remove visible accumulations of asbestos material and debris. Wet-clean all surfaces within work area.
- B. Remove the upper layer of fire-retardant polyethylene sheeting from walls and floors only. The windows, doors, and HVAC vents must remain sealed and any HEPA-filtered exhaust units, air filtration, and decontamination unit must remain in place and in service.
- C. Clean all surfaces in work area and any other contaminated areas with wet-cleaning methods using amended water, and/or using HEPA-filtered vacuums. After cleaning work area, allow for settlement of dust, and again wet-clean or clean with HEPA-filtered vacuums, all surfaces in work area. After completion of the second cleaning operation, perform a complete visual inspection of work area to ensure that work area is free of dust and/or visible asbestos debris.
- D. Time for settlement of dust between initial cleaning and final cleaning will be determined by The HazMat Project Manager. Typical settling times for various types of ACM/ACCM are: 12-16 hours for friable materials, and 3-6 hours for non-friable materials.
- E. Sealed containers and all equipment in use in work area must be included in the cleanup and must be removed from work area via equipment decontamination unit, at an appropriate time in the cleaning sequence.

### **3.4 INSPECTIONS AFTER REMOVAL**

This part is intended to be used as a general specification for inspections of work area for any particular asbestos abatement project for Owner. Consult the SCOPE OF WORK for each individual project for more specific inspection requirements.

#### **3.4.1 Inspections After Removal (see also SUB-SUB-SECTION 5.1)**

- A. If the HazMat Project Manager finds visible accumulations of asbestos debris in work area after the completion of step 3.3.1 (C), Contractor shall repeat wet-cleaning until work area is in compliance, at Contractor's expense.
- B. When an inspection by the HazMat Project Manager in the presence of Contractor determines that the area is free of accumulations of dust and visible asbestos debris and the final air clearance has been met, decontamination unit shall be removed, the area thoroughly wet-cleaned, and materials from equipment room and shower room disposed of as contaminated waste.

- C. A final inspection will be carried out by The HazMat Project Manager in the presence of Contractor to ensure that no dust or debris remains on surfaces as a result of dismantling operations.

### 3.5 DISPOSAL

This part is intended to be used as a general specification for disposal of asbestos-containing materials for any particular asbestos abatement project for Owner. Consult the SCOPE OF WORK for each individual building for more specific disposal requirements.

#### 3.5.1 Disposal

##### A. Preparation and Security of Waste Holding Areas

1. Prepare enclosed transport vehicles and/or enclosed dumpsters/containers with at least 2 layers of 6 mil fire-retardant polyethylene sheeting. The floor and interior wall surfaces shall be covered with one layer of 6-mil. plastic sheeting sealed with tape to a minimum height of 6 feet above the floor surface or to the roof line of the waste container.
2. Secure transport vehicles and dumpsters with padlocks. Dumpsters/containers and waste transport vehicles must be locked and appropriately labeled at all times while engaged in asbestos disposal on Owner's property, except when waste materials are being loaded into them.

##### B. Storage and Disposal of Containers

1. Containers of ACM/ACCM shall not be stored in uncontaminated areas, but must be moved directly from work area to a labeled, enclosed dumpster in enclosed carts.
2. ACM/ACCM must be disposed of at the selected and approved disposal site in accordance with requirements of all applicable disposal authorities. Solvents used for the removal of resilient flooring mastics/adhesives shall be low-odor. All adhesives/mastics shall be disposed of as a RCRA waste. Regardless of the solvent utilized, the contractor may have the waste profiled for RCRA composition by the HPM – all costs involved with this testing shall be borne directly by the contractor and not by the owner.
3. Disposal documents and receipts must be submitted to The HazMat Project Manager prior to final clearance of Contractor.

##### C. Contractor must tag each container with a waste manifest label and a numbering system provided by Owner, if any.

##### D. Discharge of Waste Water

1. Waste water must be filtered through a medium that is capable of removing suspended particles of a diameter greater than or equal to 3 microns. Filtered waste water must be discharged into public sanitary sewer systems. Discharge of filtered water onto surface soil, asphalt, concrete, or any other porous surface shall not be permitted.
2. Permits from local state and federal government agencies, the local water pollution control district, public sanitary sewer entity, etc. will be required on site prior to any filtered waste water being discharged from the work area or the decontamination unit's shower system. Under no circumstances shall waste water (filtered or otherwise) be discharged into a storm water drain or runoff.
3. Filtration devices' filter element or accumulation tank contents shall be removed, manifested and disposed off as friable Asbestos Containing Material at the contractors' expense.

## **SUB-SECTION 4.0**

### **SPECIAL PROCEDURES**

This section is intended to be used as a general specification for special procedures for any particular asbestos abatement project for The Owner. Contractor should consult the Scope of Work for each individual building for more specific requirements pertaining to this section.

#### **4.1 EXTERIOR ASBESTOS REMOVAL**

This part applies only to removal of non-friable exterior roofing materials, non-friable asphalt-based exterior mastic materials, or non-friable exterior asbestos cement panels. Where exterior components have a direct impact on the interior of the buildings or share a common surface with the interior of the building, or in the event of a conflict with interpretation, all procedures enumerated in section 3 of these specifications shall apply.

##### **4.1.1 Personal Protection**

- A. Exterior work may be performed using half-mask, dual cartridge, air purifying respirators. Organic vapor cartridges placed in tandem with HEPA filters shall be required when any solvents or materials that produce vapors are used as part of the removal process
- B. All workers engaged in exterior removal must wear disposable full body coveralls, disposable head covers, disposable footwear, hard hats, goggles and gloves as required by OSHA/Cal-OSHA for the complete protection of the workers.
- C. Shoes may be worn for exterior work, provided the shoes are stored in sealed bags at the decontamination area at the end of the day, and properly decontaminated after completion of the work.

##### **4.1.2 Protection from Heat Stress**

In exterior areas where heat stress to workers is inevitable, Contractor must provide frequent work breaks in cool areas outside work area, and/or body vests with ice pack inserts, depending on the site conditions.

##### **4.1.3 Decontamination Area**

- A. Locate decontamination areas in an exterior or interior area when access from the work area can be accomplished at ground level with exterior access.
- B. Contractor shall establish a decontamination area that is adjacent to the work area for the decontamination of employees and their equipment, which is contaminated with asbestos that consists of an area covered by an impermeable drop cloth on the ground or horizontal working surface.
- C. The area must be of sufficient size as to accommodate cleaning of equipment and removing personal protective equipment without spreading contamination beyond the area.
- D. Protective clothing must be cleaned with a HEPA vacuum before it is removed.
- E. All equipment and surfaces of containers filled with ACM/ACCM must be cleaned prior to removing them from the equipment room or area.
- F. Contractor shall ensure that workers enter and exit the work area through the decontamination area.

#### 4.1.4 Respirator Decontamination Facilities

A respirator decontamination facility consisting of a water hose equipped with a spray nozzle, an adequate supply of 6 mil bags, and an adequate supply of disposable towels may be used in a remote section of work area so workers may replenish body fluids with Gatorade™, or a similar electrolyte replenishing drink.

- A. Each person who uses the respirator decontamination facility shall rinse the exterior of the respirator while holding head over an open 6 mil bag.
- B. After thoroughly rinsing the respirator each person shall wipe the excess water off the exterior of the respirator with a disposable towel, and dispose of the towel in the bag.
- C. After removing excess water from the exterior of the respirator, the respirator may be removed.
- D. Waste water that has accumulated in the rinse bag shall be disposed of as ACM or properly filtered in the decontamination area.

#### 4.1.5 Exterior Asbestos Removal

- A. Provide suitable tools for removal of asbestos cement panels, roof felts, tar, and mastics. Roof cutters are permissible only when proper steps are taken to ensure dust-free removal conditions, and the building or facility owner, the HazMat Project Manager and local regulatory agencies permit the use of such equipment.
- B. For asbestos cement panels, the perimeter of the work area shall be clearly delineated and labeled with caution tape. Prior to the start of any work prepare the surrounding area by clearing and cleaning all debris and trash to a minimum of 10 feet from the exterior work area. The surrounding areas shall then be covered with one layer of 6-mil plastic sheeting. The plastic sheeting shall be sized so that it will cover a drop area with a minimum of 10 feet from the work area. Spray panels with amended water using spray equipment capable of providing a mist application to reduce the release of fibers. Saturate the material sufficiently to wet the material without causing excess dripping.
- C. Remove wet asbestos cement material in small sections. As it is removed wrap the material in 6-mil fire-retardant polyethylene sheeting and place in appropriately labeled (29 CFR 1926.1101(k)(8)(iii)) containers lined with 6-mil fire-retardant polyethylene sheeting and enclosed truck or closed dumpster for transport.
- D. Asbestos cement panels must be removed carefully and in complete sections. Breakage of the panels must be minimized, and must not be used as a method of removal without prior written approval of the HazMat Project Manager.
- E. For removing roofing material which contains ACM/ACCM Contractor shall ensure that the following work practices are followed:
  - 1. The perimeter of the building shall be clearly delineated and labeled with caution tape. Prior to the start of any work on the roof, prepare the surrounding area below by clearing and cleaning all debris and trash to a minimum of 15 feet from the exterior walls of the building. The surrounding areas shall then be covered with one layer of 6-mil plastic sheeting. The plastic sheeting shall be sized so that it will cover a drop area with a minimum of 15 feet from the exterior wall. The interior of the building shall be appropriately and adequately protected from debris that may fall through the roof decking during removal.
  - 2. Roofing material shall be removed in an intact state to the extent feasible.
  - 3. Wet methods shall be used to remove roofing materials that are friable, or that will be rendered friable during removal, unless such wet methods are not feasible or will create safety hazards.

4. Cutting machines, if permitted for use, shall be continuously misted during use, unless a competent person determines that misting substantially decreases worker safety.
  5. When removing built-up roofs with asbestos-containing roofing felts and an aggregate surface using a power roof cutter, all dust resulting from the cutting operation shall be collected with a HEPA-filtered dust collector, or shall be HEPA vacuumed by vacuuming along the cut line.
  6. When removing built-up roofs with asbestos-containing roofing felts and a smooth surface using a power roof cutter, if permitted for use, the dust resulting from the cutting operation shall be collected either by a HEPA dust collector or HEPA vacuuming along the cut line, then carefully and completely wipe up the still-wet dust and debris left along the cut line.
- F. Asbestos-containing material that has been removed from a roof shall not be dropped or thrown to the ground. Unless the material is carried or passed to the ground by hand, it shall be lowered to the ground via covered, dust-tight chute, crane or hoist:
1. Any ACM/ACCM that is not intact shall be lowered to the ground as soon as is practicable, but in any event no later than the end of the work shift. While the material remains on the roof it shall either be kept wet, placed in an impermeable waste bag, or wrapped in plastic sheeting.
  2. Intact ACM/ACCM shall be lowered to the ground as soon as is practicable, but in any event no later than the end of the work shift.
- G. Upon being lowered, unwrapped material shall be transferred to a closed receptacle in such manner so as to preclude the dispersion of dust.
- H. Roof level heating and ventilation air intake sources shall be isolated after these ventilation systems have been shut down.
- I. After completion of removal work, all surfaces from which asbestos has been removed must be wet-cleaned, and the entire surface must be vacuumed with a HEPA-filtered vacuum.
- J. Any adhesive materials such as mastic, asphalt, or tar must be removed using a suitable (non-toxic) solvent. The residue must be bagged and properly disposed of as ACM. On porous or irregular surfaces where all traces of ACM/ACCM cannot be removed, encapsulant may be applied. Prior to encapsulation, however, these areas must be inspected and approved by the HazMat Project Manager.

## 4.2 GLOVE BAG PROCEDURE

The glove bag is a specialty procedure that shall be utilized only when specified in the SCOPE OF WORK of these specifications. Glove bag procedures may only be performed when access and preparation limit possibilities for removal. The procedure shall only be utilized when circumstances dictate this type of removal, as determined by The HazMat Project Manager.

### 4.2.1 Personal Protection

- A. The glove bag procedure may be performed using half-mask, dual cartridge, air purifying respirators, provided Contractor shows previous, similar work has not produced airborne fiber levels in excess of 0.01 fibers/cc during the glove bag removal procedure. If the contractor cannot produce the required negative exposure assessment, the HazMat Project Manager may require the contractor's personnel to utilize Powered Air Purifying Respirators (PAPR's).



- B. All workers engaged in exterior removal must wear disposable full body coveralls, disposable head covers, disposable footwear, hard hats, goggles and gloves as required by OSHA/Cal-OSHA for the complete protection of the workers.
- C. Shoes may be worn for exterior work, provided the shoes are stored in sealed bags at the decontamination area at the end of the day, and properly decontaminated after completion of the work.

#### **4.2.2 Preparation for Glove Bag Procedure**

- A. Post warning signs and barrier tape in and around work area as required by all applicable regulatory agencies, and restrict access to work area to personnel approved by The HazMat Project Manager.
- B. Shut down electric power when necessary. Provide temporary power and lighting and ensure safe installation of temporary power sources and equipment per applicable electric code requirements. Use ground-fault interrupter circuits (GFIC) at power receptacles in work area.
- C. Seal vents within work area with, at least, tape and fire-retardant polyethylene sheeting during the work.
- D. Cover moveable objects within the proposed work areas using 6-mil fire-retardant polyethylene sheeting, as appropriate, or remove such objects from work area to a suitable temporary location.
- E. Cover areas beneath and adjacent to the proposed work using 6 mil fire-retardant polyethylene sheeting, as appropriate. Cover scaffolding with at least one layer of 6 mil fire-retardant polyethylene sheeting, when appropriate.
- F. Prepare curtained doorways at entrances to and exits from work area.

#### **4.2.3 Decontamination Room or Area**

- A. Contractor shall establish an equipment room or area that is adjacent to the glove bag work area for the decontamination of workers and equipment contaminated with asbestos. The decontamination area shall consist of an area covered by an impermeable drop cloth on the floor or horizontal working surface, and be of sufficient size as to accommodate cleaning of equipment and removing personal protective equipment without spreading contamination beyond the area.
- B. Workers may use double suits, or decontaminate a single suit with a HEPA-filtered vacuum. Before leaving work areas each worker must remove and dispose of the outer suit (if double suits are used) and dispose of this suit in a suitable container (see **SUB-SUB-SECTION 3.5.1, DISPOSAL**), or thoroughly vacuum the suit using a HEPA-filtered vacuum (if single suits are used) before leaving the glove bag work area to enter decontamination room or area.
- C. All equipment and surfaces of containers filled with ACM/ACCM must be cleaned prior to removing them from the decontamination room or area.
- D. Contractor shall ensure that employees enter and exit the regulated glove bag work area through the decontamination room or area.

#### 4.2.4 Separation of Work Areas from Occupied Areas

##### A. Maintenance of Critical Barriers

1. Ensure that barriers and fire-retardant polyethylene linings are effectively sealed and taped. Repair damaged barriers and remedy defects immediately upon discovery. Maintenance is to continue until clearance to remove critical barriers is given by the HazMat Project Manager.
2. Supervisor shall visually inspect critical barriers continually for the duration of each work shift.

##### B. Asbestos abatement work shall not begin until:

1. Documentation for all on-site supervisors and workers has been submitted to, reviewed and accepted by the HazMat Project Manager. Supervisor and worker documents include current training certification(s), current medical surveillance certification and current respirator fit-testing certification. One copy of each of the aforementioned documents is to be submitted to the on site the HazMat Project Manager or their representative along with a copy of the notification to Cal/OSHA and the local air pollution control district, if required. A second copy is to be maintained on-site by the supervisor. It is the supervisors' responsibility to maintain current on-site documentation for all personnel substitutions or alterations.
2. All HEPA filter equipped differential pressure units and vacuum cleaners have been DOP tested and passed on site and are certified for use.
3. Arrangements have been made for the transportation and disposal of waste at the selected and approved landfill, as identified in Contractor submittals.
4. Decontamination units are in place and the work area is effectively isolated from the remainder of the building
5. All other preparatory steps have been taken and applicable notices posted and permits obtained.
6. Only when all the above conditions have been met will Contractor be allowed to begin the disturbance of any ACM/ACCM. An inspection of each containment by the HazMat Project Manager will be performed prior to the start of removal. Removal shall not be performed until the condition of each containment is approved by the HazMat Project Manager.

#### 4.2.5 Asbestos Removal

- A. Install glove bag according to manufacturers recommendations, and in accordance with 29 CFR 1926.1101(g)(5)(ii).
- B. Cut covering on insulation along the top seam to allow wetting of the insulation, and cut cover all around section to be removed.
- C. Remove ACM/ACCM in small sections. Lower the insulation carefully in the bottom of the glove bag. Do not drop material. One glove bag must be used for each section of ACM/ACCM to be removed. Sliding or re-use of a single glove bag is strictly prohibited. Use appropriate size bag for the dimensions of the material to be removed to ensure economy of materials.
- D. Prior to removal of the glove bag, ensure that all surfaces from which asbestos has been removed are clean of all visible material, and that the upper portion of the bag is clean of all visible waste. Spray all surfaces and tools in the glove bag with amended water. Wipe all sections of pipe with rag or appropriate material. Wipe upper section of bag as well.

- E. Use appropriate encapsulant on all surfaces inside the bag. Cover exposed insulation remaining on pipes with wettable fiberglass or other suitable material. Duct tape is not suitable for this purpose.
- F. Place tools inside sleeves of glove bag and isolate from interior of glove bag. Collapse bag using HEPA-filtered vacuum. Squeeze and twist bag at mid-level to isolate waste from upper portion of bag. Seal bag with duct tape or locking ties. Vacuum the unsealed upper portion. Keep the HEPA-filtered vacuum connected until the glove bag is removed. Cut the glove bag along the top and sides, then remove from pipe. Cut off isolated sleeves containing any tools or supplies from the bag and place in bucket of water. Clean the tools in equipment room of decontamination unit. Place the glove bag inside a 6-mil waste bag and seal the top of the waste bag by “goose necking” it and sealing it with duct tape.
- G. Disposal of glove bag, material, and wastewater (see **SUB-SUB-SECTION 3.5.1 DISPOSAL**).

### **4.3. MINI-CONTAINMENT PROCEDURE**

The mini-containment may be specified in certain instances, such as removal of ACM/ACCM from a small ventilation system or from a short length of duct where a glove bag may not be appropriate to adequately contain the asbestos fibers during removal. The procedure shall only be utilized when circumstances dictate this type of removal, as determined by the HazMat Project Manager.

#### **4.3.1 Personal Protection**

- A. The mini-containment procedure may be performed using half-mask, dual cartridge, air purifying respirators, provided Contractor shows previous, similar work has not produced airborne fiber levels in excess of 0.01 fibers/cc during mini-containment removal procedures in the past. If the contractor cannot produce the required negative exposure assessment, the HazMat Project Manager may require the contractor’s personnel to utilize Powered Air Purifying Respirators (PAPR’s).
- B. All workers engaged in exterior removal must wear disposable full body coveralls, disposable head covers, disposable footwear, hard hats, goggles and gloves as required by OSHA/Cal-OSHA for the complete protection of the workers.
- C. Shoes may be worn for this work, provided the shoes are stored in sealed bags at the decontamination area at the end of the day, and properly decontaminated after completion of the work.

#### **4.3.2 Preparation for Mini-Containment Procedure**

- A. Post warning signs and barrier tape in and around work area as required by all applicable regulatory agencies, and restrict access to work area to personnel approved by The HazMat Project Manager.
- B. Shut down electric power when necessary. Provide temporary power and lighting and ensure safe installation of temporary power sources and equipment per applicable electric code requirements. Use ground-fault interrupter circuits (GFI) at all power receptacles in work area. Locate power source for electrical equipment outside work area.
- C. Seal off all openings, including but not limited to: vents, ducts, grills, diffusers, and any other penetrations of work area within mini-containment with, at least, tape and fire-retardant polyethylene sheeting.
- D. When appropriate, clean moveable objects within the proposed work areas using HEPA-filtered vacuums and/or wet-cleaning methods as appropriate, or remove such objects from work area to a suitable temporary location.
- E. When appropriate, clean fixed objects within the proposed work area using HEPA-filtered vacuums and/or wet-cleaning methods as appropriate, and cover objects with 6 mil fire-retardant polyethylene sheeting.

- F. Construct mini-containment using a single layer of fire-retardant polyethylene sheeting placed over a temporary frame constructed with 2"x 4" lumber, PCV tubing or other suitable material, as determined by the HazMat Project Manager. When permanent walls are present, and will suffice for containment barriers, cover walls and ceilings with a single layer of fire-retardant polyethylene sheeting.
- G. Construct a decontamination room contiguous to the mini-containment consisting of a single layer of fire-retardant polyethylene sheeting attached to 2"x 4" lumber, PCV tubing or other suitable material, as determined by the HazMat Project Manager. The decontamination room shall be of sufficient size as to accommodate cleaning of equipment and removing personal protective equipment, and shall have curtained doorways at the entrance to work area and exit to uncontaminated areas.
- H. Place HEPA-filtered vacuum or low-volume HEPA-filtered exhaust unit in such a manner that a pressure differential can be established in the change room.
- I. Doorways and corridors outside the mini-containment that will not be used for passage during work must be barricaded with barrier tape.

#### 4.3.3 Decontamination Room or Area

- A. Contractor shall establish an equipment room or area that is contiguous with the mini-containment work area for the decontamination of workers and equipment contaminated with asbestos. The decontamination area shall consist of an area covered by a impermeable drop cloth on the floor or horizontal working surface, and be of sufficient size as to accommodate cleaning of equipment and removing personal protective equipment without spreading contamination beyond the area.
- B. Workers may use double suits, or decontaminate a single suit with a HEPA-filtered vacuum. Before leaving work areas each worker must remove and dispose of the outer suit (if double suits are used) and dispose of this suit in a suitable container (see **SUB-SUB-SECTION 3.5.1, DISPOSAL**), or thoroughly vacuum the suit using a HEPA-filtered vacuum (if single suits are used) before leaving the decontamination room.
- C. All equipment and surfaces of containers filled with ACM/ACCM must be cleaned prior to removing them from the decontamination room or area.
- D. Contractor shall ensure that employees enter and exit the regulated mini-containment work area through the decontamination room or area.

#### 4.3.4 Separation of Work Areas from Occupied Areas

- A. Contractor shall ensure that barriers and fire-retardant polyethylene linings are effectively sealed and taped. Damaged barriers shall be repaired and defects remedied immediately upon discovery. Maintenance is to continue until clearance to remove mini-containment is given by The HazMat Project Manager.
- B. Asbestos abatement work shall not begin until:
  1. Arrangements have been made for disposal of waste at the selected and approved landfill, as identified in Contractor submittals.
  2. Mini-containment and decontamination unit are in place and work area is effectively isolated from the remainder of the building.
  3. All other preparatory steps have been taken and applicable notices posted and permits obtained.

4. Only when all the above conditions have been met will Contractor be allowed to begin disturbance of ACM/ACCM. An inspection of the mini-containment by the HazMat Project Manager will be performed prior to the start of removal. No removal shall be performed until the condition of the mini-containment is approved by the HazMat Project Manager.

#### **4.3.5 Asbestos Removal**

- A. Mist materials with amended water and remove materials in small sections. Place in bag immediately.
- B. Wipe down exposed surfaces with amended water and rags.
- C. Seal bags or containers. Clean external surfaces of containers thoroughly by wet-cleaning in the mini-containment.

#### **4.3.6 Waste Load-out Procedure**

See SUB-SUB-SECTION 3.2.1, PARAGRAPH E, WASTE LOAD-OUT PROCEDURES, STEPS 1-5.

#### **4.3.7 Cleanup and Encapsulation**

- A. After completion of removal work, all surfaces from which asbestos has been removed must be brushed and/or wet-cleaned by an equivalent method to remove all visible material. During this work the surfaces being cleaned must be kept wet with solvent, unless otherwise noted in the Scope of Work
- B. The HazMat Project Manager will individually approve each area for encapsulation in writing prior to commencement of encapsulation.
- C. Encapsulant is to be applied only to surfaces from which ACM/ACCM has been removed and shall not be used as a method for sealing dust on surfaces.

#### **4.4 DECONTAMINATION OF CONTAMINATED AREAS**

In the event that an area of a building is determined by the HazMat Project Manager or The Owner as being contaminated with asbestos dust or debris, the area must be decontaminated using the procedures included in this part of the specification.

##### **4.4.1 Personal Protection**

- A. All personnel entering an area that is visibly contaminated with assumed, suspected, or known ACM/ACCM must wear half-mask, dual cartridge, air purifying respirators and protective clothing to install temporary barriers and begin preparation of the contaminated area.
- B. When area or personal air samples indicate a level of airborne fibers to be in excess of 0.1 fibers/cc, all personnel in the contaminated area must use PAPR until fiber concentrations are consistently measured below 0.1 fibers/cc.
- C. When area or personal air samples indicate a level of fiber concentrations to be in excess 1.0 fibers/cc, all personnel in the contaminated area must use a PAPR or Type C, pressure demand respirator until fiber concentrations are measured below 1.0 fibers/cc.
- D. All personnel entering the contaminated area must wear protective clothing and use decontamination units upon leaving the contaminated area.

#### 4.4.2 Preparation

- A. Immediately shut down and isolate heating, cooling and ventilating air systems to prevent contamination and fiber dispersal to other areas of the structure. Adequately wet all visible asbestos debris in the contaminated area. Cover vents within the contaminated area with tape and fire-retardant polyethylene sheeting.
- B. Seal off contaminated area with temporary barriers constructed with 6-mil fire-retardant polyethylene sheeting. Construct curtained doorway for temporary access to contaminated area.
- C. Construct a worker decontamination unit contiguous to the contaminated area consisting of three totally enclosed rooms as follows:
  - 1. An equipment room with two curtained doorways, one to the contaminated area and one to shower room.
  - 2. A shower room with two curtained doorways, one to equipment room and one to clean room. Shower room must contain at least one shower with hot and cold water. Water must be mixed at point of use (29 CFR 1910.141)
    - a. Careful attention must be paid to shower room to insure against leaking of any kind and to insure proper drainage of shower water. There must be no standing water in the shower stall or shower room. Insure a supply of soap at all times in shower room.
    - b. Waste water must be filtered through a medium that is capable of removing suspended particles of a diameter greater than or equal to 3 microns. Filtered waste water must be discharged into public sanitary sewer systems. Discharge of filtered water onto surface soil, asphalt, concrete, or any other porous surface shall not be permitted. Permits from local state and federal government agencies, the local water pollution control district, public sanitary sewer entity, etc. will be required on site prior to any filtered waste water being discharged from the work area or the decontamination unit's shower system. Under no circumstances shall waste water (filtered or otherwise) be discharged into a storm water drain or runoff.
  - 3. A clean room with one curtained doorway into shower room and one entrance or exit to uncontaminated areas of the building. Clean room must have sufficient space for storage of the workers street clothes, towels, and other uncontaminated items.
- D. Seal off all openings, including but not limited to: corridors, doorways, elevators, skylights, ducts, grills, diffusers, and any other penetrations to the contaminated areas. Doorways and corridors that will not be used for passage during work must be sealed with barriers. These seals are barriers critical to the integrity of containment and must be left in place until final air testing is complete and the results received and approved.

#### 4.4.3 Establish Pressure Differential

- A. Install HEPA-filtered differential pressure unit in work area to lower concentration of airborne fibers in work area and contain airborne fibers. All differential pressure units shall be challenge tested on site to verify the efficiency of the HEPA Filtration Units to ensure that the units are filtering at a minimum of 99.97% efficiency for mono-dispersed particulate 0.3 micrometers in diameter. Challenge testing shall be performed using DOP or equivalent by persons conversant and experienced in the usage and testing of HEPA filtration units. Testing certificates shall be presented on site to the HazMat Project Manager or affixed to the machines. No differential pressure unit or other HEPA filter equipped equipment shall be used on site until and unless it has been tested and passed this challenge test.
- B. All work areas must be placed under a pressure differential of at least minus 0.02 inches of water column, with respect to outside areas, prior to disturbance of asbestos-containing materials. The pressure differential equipment utilized shall be, at a minimum, capable of performing four (4) complete air exchanges per hour. For the purposes of

this project, each pressure differential unit shall be evaluated at 75% of the manufacturers rated capacity. For example, if the manufacturers rated capacity for a differential pressure unit is 2,000 cfm., for the purpose of this project, that particular unit will be evaluated as having a maximum capacity of 1,500 cfm. The contractor shall provided the necessary equipment to maintain the required minus 0.02 inches of water column PLUS 20% (or a minimum of one machine – which ever is greater) additional equipment in the event of equipment malfunction work area changes, etc. The unused equipment shall be tested, installed in the work area, sealed and kept in a state of readiness to be brought on line, if necessary, at very short notice.

- C. Locate HEPA-filtered exhaust units so that make-up air enters work area through decontamination unit, or other suitable source of make-up air. Place HEPA-filtered exhaust units as far as possible from the entrance/exit or other make-up air sources.
- D. Exhaust ducts shall be attached plywood cut-outs and placed through opening window, door, or wall, then sealed with tape and vented to the outside of the building. Exhausts ducts shall not be placed adjacent to ventilation or HVAC units. The plywood cut-outs shall be attached to the building securely to prevent entry, theft or vandalism to the owners' property.
- E. Start HEPA-filtered exhaust units prior to removal and continue operating continuously until final air clearance of work area has been successfully obtained.
- F. Replace air filters in HEPA-filtered exhaust unit when the unit's manometer indicates that a pressure drop across the filters exceeds 1.0 inch of water, replace pre-filter first, then the secondary filter and finally the HEPA filter.
- G. HEPA-filtered exhaust units will be inspected daily by The HazMat Project Manager to ensure proper maintenance, and correct placement of filters. The inspection results will be noted in the HazMat Project Manager's daily logs.
- H. Pressure differential recorders (manometers) equipped with an acceptable method of self-recording, i.e., circular recorders, strip charts, print-out, etc. are required in each work area to monitor the pressure difference between the work area and the ambient conditions in the surrounding areas. The recording system shall be accurate to the nearest 0.001 inches of water column differential and be equipped with a functioning audible alarm that sounds if the difference becomes less than minus 0.020-inches water column. The recorders must be calibrated prior to their use and re-calibrated on a daily basis prior to the commencement of the work shift. The daily record produced by the machine is to be marked with the project name, location, date, and time handed over to the HazMat Project Manager or the owners' on-site representative at the conclusion of each work shift.
- I. When pressure differential system is shut down at the end of the project, the filters must be left in HEPA-filtered exhaust unit and HEPA-filtered vacuums, and openings on these items must be sealed with polyethylene sheeting and duct tape. Exhaust tubes and vacuum tubes for the HEPA-filtered must be sealed with duct tape in double bags or 2 layers of fire-retardant polyethylene sheeting. Filters on these pieces of equipment must not be replaced after final cleanup is complete to avoid any risk of re-contaminating the area.

#### **4.4.4 Decontamination of Contaminated Surfaces**

- A. Clean moveable objects and carpeting within the contaminated areas using HEPA-filtered vacuums and/or wet-cleaning methods as appropriate, and remove such objects from the contaminated area to a suitable temporary location. Refer to SUB-SECTION 5.4(B) for Re-establishing object and systems.
- B. Clean fixed objects, including ceiling and wall fixtures, within the contaminated area using HEPA-filtered vacuums and/or wet-cleaning methods as appropriate.
- C. Clean all exposed surfaces in the contaminated area using HEPA-filtered vacuums or wet-cleaning methods as appropriate. Methods that raise dust, such as dry sweeping or vacuuming with equipment not equipped with HEPA filters shall not be used.

## SUB-SECTION 5.0

### INSPECTIONS, PROJECT MANAGEMENT, AIR MONITORING AND COMPLETION

#### 5.1 INSPECTIONS

This section is intended to be used as a general specification for inspections, air monitoring, and completion for any particular asbestos abatement project for the owner. Consult the Scope of Work for each individual building, for more specific requirements pertaining to this section, if any.

##### 5.1.1 Inspections Prior to and During Work

- A. Contractor shall make all work areas available to inspection throughout the project.
- B. Each work area will be inspected by HazMat Project Manager accompanied by Contractor:
  - 1. Immediately after initial cleaning has been completed and prior to the application of fire-retardant polyethylene sheeting to exposed surfaces.
  - 2. Immediately prior to the commencement of removal of ACM/ACCM (after preparation of work area is complete).
  - 3. Periodically throughout the project.
  - 4. After removal is complete but prior to the application of any encapsulant to the exposed substrates, and pre-encapsulation air testing.
- C. Regular inspections of the HEPA-filtered ventilation system will be performed by HazMat Project Manager to ensure filters are excessively loaded with particulate debris, and are properly seated in HEPA-filtered exhaust units. If deemed necessary by the HazMat Project Manager, the contractor will be required to change the filters.

##### 5.1.2 Inspection of Non-asbestos Containing Materials

HazMat Project Manager may inspect all materials from work area that are being disposed of as Non-asbestos Containing Materials.

##### 5.1.3 Final Visual Inspections

- A. A final visual inspection will be made after all Contractors' materials have been removed from work area and all removal, encapsulation, disposal, and related work is completed.
- B. Work area must be well lighted for inspection by HazMat Project Manager. Insufficient lighting may result in delay of the final visual inspection.
- C. All fire-retardant polyethylene sheeting must be removed from work area, with the exception of critical barriers, and decontamination unit. HEPA-filtered exhaust units must remain operational, and pressure differential maintained until final clearance by TEM or PCM is obtained.



## **5.2 PROJECT MANAGEMENT**

### **5.2.1 Project Management**

- A. The owner will employ HazMat Project Manager to conduct on-site Project Management for all phases of the asbestos abatement work.
- B. HazMat Project Manager will be responsible for:
  - 1. Approval of all submittals by Contractor, including pay requests.
  - 2. Conducting all inspections at the job site, as required. Monitoring job site performance and progress.
  - 3. Performing all personal, area, and final air testing throughout the course of each project. Personal testing by the HazMat Project Manager will be for the owners use and records only. The contractor is responsible for collecting all personnel samples as may be required by these specifications, local, state and federal regulations, etc.
  - 4. Submitting final report to the owner that will include all documents, logs, charts, photographs, and test results pertaining to each project.

## **5.3 AIR MONITORING**

### **5.3.1 General**

- A. The Asbestos Contractor is responsible for the personal air sampling. All other air sampling will be performed by HazMat Project Manager. Personal, area, and pre-encapsulation air samples will be analyzed by an NVLAP-accredited laboratory using NIOSH method 7400 using phase contrast microscopy (PCM) or by an individual possessing a valid NIOSH-582 equivalency qualifications. If deemed appropriate by the HazMat Project Manager, PCM may be used for final air testing.
- B. Final air samples will be analyzed by a laboratory accredited by NVLAP for Transmission Electron Microscopy (TEM), using the AHERA Mandatory Transmission Electron Microscopy Method in Appendix A of 40 CFR 763, subpart E.

### **5.3.2 Background Air Testing**

- A. Background Air Testing will be carried out by HazMat Project Manager prior to initiation of work by Contractor in order to establish background levels of contamination.
- B. If air monitoring, during work by Contractor, shows an increase in airborne fiber concentrations outside containment system, work shall cease until the source of the contamination is found and remedied to HazMat Project Manager's satisfaction. Any areas that have been contaminated as a result of Contractor's work shall be cleaned by Contractor at his expenses and without impact to the schedule agreed to by the owner and the contractor.
- C. Background air samples will be analyzed by PCM. TEM analysis of questionable samples will be made available at the expense of Contractor should he request it. All such requests are to be made in writing.

### **5.3.3 Personal Air Sampling**

- A. The personal air monitoring will consist of:

1. An 8 hour Time Weighted Average (TWA) for samples collected on 25% of the work force during each eight hour shift for the duration of the project.
2. Continuous personal monitoring to be conducted during preparation, removal, and final cleanup, unless Type C pressure demand respiratory protection is used.
3. Excursion Limit or Short Term Exposure Limit (STEL) sampling shall be performed during all phases of the asbestos abatement project to establish the STEL for each job function. The STEL shall be for a duration of 30 minutes and be collected midway through the work shift.
4. All personal air samples shall be analyzed by NIOSH method 7400 (PCM) or NIOSH method 7402 (TEM) only.

#### **5.3.4 The Pre-encapsulation Test**

- A. After successful completion of the pre-encapsulation inspection, but prior to removal of the wall and floor coverings, critical barriers, decontamination unit, and use of any encapsulant, HazMat Project Manager may conduct pre-encapsulation air testing.
- B. This will consist of filtered air samples of sufficient volume to yield a detection limit of less than 0.01 fibers/cc.
  1. The sampling will not begin until work area is dry.
  2. Sampling will utilize aggressive techniques (a 1 HP leaf blower and electric fans) to re-suspend any dust or material that has settled in work area.
  3. The pre-encapsulation air testing will be analyzed by PCM (NIOSH 7400) with a concentration of 0.01 fibers/cc being acceptable (see **SUB-SUB-SECTION 5.3.6** for discussion of confidence limits).

#### **5.3.5 Conditions for Final Air Testing**

- A. Final air testing shall take place when removal is complete, the fire-retardant polyethylene sheeting not necessary to the integrity of containment removed, and a visual inspection of work area shows that work area is clean and dry.
- B. Contractor should expect a delay of at least 24 hours from the time the samples reach the laboratory to the time the results are known for all PCM analyses. HazMat Project Manager will make every reasonable effort to obtain these results in a time period suitable to Contractor's work schedule.
- C. Contractor should expect at least a 48 hour delay from the time the samples reach the laboratory to the time the results are known for samples analyzed by TEM. HazMat Project Manager will make every reasonable effort to obtain these results in a time period suitable to Contractor's work schedule.

#### **5.3.6 Air Clearance Criteria**

- A. HazMat Project Manager and Contractor recognize the samples taken for all PCM clearance or pre-encapsulation samples must meet a standard that allows HazMat Project Manager 95% certainty that the sample does not in fact meet the 0.01 fibers/cc final air standard. Ninety-five percent certainty is defined by the equation:  
 $MC + 1.645 (CV) (FAS) = 95\% \text{ confidence level}$

where:

MC = measured concentration of fibers

CV = coefficient of variation

FAS = final air standard

- B. The results of this equation must be less than the final air standard for any sampled area to pass the test.
- C. For samples analyzed by the Transmission Electron Microscope Method, the arithmetic mean of the measured airborne asbestos concentration for the five inside samples must be less than or equal to 70 structures per square millimeter (70 s/mm<sup>2</sup>).

#### **5.3.7 Final Air Testing**

- A. After work area has met the 0.01 fibers/cc standard for the pre-encapsulation test (if performed), final air testing will be conducted and analyzed by Transmission Electron Microscopy (TEM), when the amount of ACM/ACCM removed in work area is greater than 160 square feet, or 260 linear feet. Final air testing will consist of five TEM samples inside work area the arithmetic mean of the measured airborne asbestos concentration for the five inside samples must be less than or equal to 70 structures per square millimeter (s/mm<sup>2</sup>). The sampling procedures and guidelines in EPA 40 CFR 763 part III will be followed.
- B. When the amount of ACM/ACCM removed in work area is less than 160 square feet or 260 linear feet, the results of the pre-encapsulation (PCM) air test will be considered as the criteria for Contractor compliance, unless TEM analysis is required by the owner.
- C. The HazMat Project Manager shall, after evaluation site conditions and at his/her discretion chose and perform the appropriate air testing.

#### **5.3.8 Final Air Testing: Exterior Areas**

Final air testing may not be required for exterior, open work areas. Instead, a thorough and meticulous inspection will be performed by HazMat Project Manager to determine Contractor compliance.

#### **5.3.9 Final Air Testing: Glove Bag Procedure**

- A. Each work area in which glove bag removal has occurred shall be visually inspected by HazMat Project Manager prior to final air testing.
- B. Aggressive sampling procedures will not be used unless work areas are fully contained by critical barriers.
- C. Each work area may be tested and analyzed by the PCM method, using static sampling procedures, unless conditions allow aggressive testing (see B. above).
- D. A TEM final air test of the general areas of glove bag removal may be performed at the owner's discretion upon failure of a PCM final.

#### **5.3.10 Failure of Final Air Tests**

- A. When the results of the final air test show values of airborne asbestos in excess of the final air standard, Contractor must re-clean work area.
- B. The final air testing procedure shall then be repeated at Contractor's expense. This shall include, but not be limited to, the sampling and analysis costs for the monitoring air samples during re-cleaning and the final air clearance, HazMat Project Manager's costs and expenses, any and all contractual penalties, liquidated damages, etc., levied by the owner and/or other trades that may be impacted by the change in schedule.

### 5.3.11 Availability of HazMat Project Manager

- A. The HazMat Project Manager will be on-site or on-call and available within 2 hours at all times.
- B. Contractor must notify HazMat Project Manager of the work schedule both at the start of the job and on a daily basis.
- C. Departures from this schedule may result in charges for waiting or unnecessary site visits and shall be charged to Contractor.
- D. Calls that require HazMat Project Manager to work overtime are subject to the approval by the owner.

## 5.4 COMPLETION

### 5.4.1 Completion

- A. Completion Criteria
  1. After final inspections and final air testing are complete and the results known, HazMat Project Manager will advise Contractor of the test results.
  2. When a work area fails either the inspection or the final air testing, the area must be re-cleaned, re-inspected and re-tested. The sequence of re-cleaning and re-testing shall continue until the area passes the inspection and the final air test. Refer to paragraph 5.3.10 *et seq.* above for additional information.
  3. When work area has passed final air test, Contractor will be informed immediately.
  4. The contractor shall remove all plastic sheeting, critical barriers, decontamination units, etc. All plastic sheeting, and other consumables shall be disposed of as asbestos contaminated waste.
- B. Re-establishment of Objects and Systems

When the project is complete:

1. Relocate all objects moved to temporary locations in the course of the work to their former positions.
2. Where HVAC, mechanical, and electrical systems have been shut down or disconnected, restore these systems to proper working order.
3. Any areas or finishes where damage may have occurred by the actions of the contractor including, but not limited to tape, staples, nails, spray-poly, water damage to Ceiling, Wall and Floor finishes Furniture and Fixtures, Exterior Areas – landscaping, shrubbery, trees, pots, ornaments, etc. shall be restored to their original condition by the contractor at his expense and without adversely impacting the schedule for the project. All restoration shall be to the satisfaction of the owner. The owner reserves the right to withhold payment for the lack of restoration of any property destroyed or damaged by the contractor.
4. Submit to the HazMat Project Manager or his designee the contractors “close out” submittal to included, all manifests, waste hauler trip tickets, work area entry and exit logs, personnel air monitoring sample results, differential pressure recorders print-outs/charts, accident reports if any or a confirmation statement from the site supervisor stating that there were no accidents on this project, a confirmation statement from the site supervisor enumerating the type, location quantity of asbestos containing material removed throughout this project, etc.

## **SUB-SECTION 6.0**

### **ALTERNATE PROCEDURES AND VIOLATIONS OF SPECIFICATIONS**

This section is intended to be used as a general specification for alternate procedures for all projects for Owner. Consult the specific scope-of-work sheet, for each individual building, for more specific requirements pertaining to this section, if any.

#### **6.1 Alternate Procedures**

- A. Procedures described in this specification must be utilized at all times.
- B. When specific procedures cannot be utilized, a request must be made in writing to HazMat Project Manager providing details of the problem encountered and recommended alternatives.
- C. Alternative procedures must provide equivalent or greater protection than procedures that they replace.
- D. Any alternative procedure must be approved in writing by HazMat Project Manager prior to implementation.

#### **6.2 Violations of Specifications**

- A. Owner will enforce these specifications through HazMat Project Manager.
- B. HazMat Project Manager/Owner shall issue cease work orders upon discovery of any violation of these specifications.
- C. Minor infractions of the specifications may result in cessation of work until the infraction is corrected.
- D. Major violations of this specification may result in the dismissal of the contractor from all asbestos abatement work, and application of liquidated damages as stated and agreed to by Contractor in contract documents.

## SUB-SECTION 7.0

### EMERGENCY PLANNING

- A. Emergency planning must be developed by Contractor and approved by Owner and HazMat Project Manager.
- B. Emergency procedures must be in written form and prominently posted in clean room and equipment room of worker decontamination unit. Prior to entering work area everyone must read and sign these procedures to acknowledge receipt and understanding of work site layout, location of emergency exits, and emergency procedures.
- C. Emergency planning must include:
  - 1. Written notification of police, fire and emergency medical personnel of planned abatement activities, work schedule, and layout of work area.
  - 2. An employee safety meeting must be conducted by Contractor prior to the commencement of each work shift. The meeting shall be attended by all Contractor employees on site, and HazMat Project Manager. All aspects of emergency planning shall be covered in the meeting.
  - 3. Access to fire extinguishers both inside and outside the work area.
- D. Emergency planning must include:
  - 1. Considerations of fire, explosion, toxic atmospheres, electrical hazards, slips, falls and trips, confined spaces and heat related injury.
  - 2. A copy of the emergency procedures and evidence employee training in these procedures shall be provided to Owner.
- E. Evacuation and Emergency Decontamination Procedures
  - 1. Employees must be trained in evacuation procedures in the event of workplace emergency.
  - 2. For non-life threatening situations, employees injured or otherwise incapacitated must decontaminate following normal procedures, with assistance from fellow workers if necessary, before exiting the workplace to obtain proper treatment.
  - 3. For life-threatening injury or illness, worker decontamination shall take least priority after measures to stabilize the injured worker, remove him from the workplace and secure proper medical treatment.
- F. Telephone numbers of all emergency response personnel must be prominently posted in the clean room and equipment room, along with the a map of, and clearly marked route to, the location of the nearest hospital emergency room.

## SUB-SECTION 8.0

### FIRE SAFETY AND SAFE EGRESS

#### 8.1 FIRE PROTECTION AND PREVENTION

##### 8.1.1 Fire Protection Program

- A. Contractor shall be responsible for the development of a fire protection program to be followed throughout all phases of demolition and abatement work, and shall provide firefighting equipment as specified in this section.
- B. As fire hazards occur, there shall be no delay in providing the necessary equipment.

##### 8.1.2 Fire Extinguishers

- A. Contractor shall provide a fire extinguisher, rated not less than 2A, for each 3,000 square feet of demolition/abatement work area.
- B. Travel distance from any point of the protected area to the nearest extinguisher shall not exceed 100 linear feet. This distance shall decrease in areas of limited mobility.
- C. A fire extinguisher may be substituted with a 2" diameter garden hose not exceeding 100 linear feet in length.

##### 8.1.3 Sprinkler Systems

- A. During renovation, abatement, or alterations, the existing fire sprinkler system shall be maintained in service at all times.
- B. If building is scheduled for complete demolition, existing sprinkler system shall be retained in service as long as reasonable.

##### 8.1.4 Fire Alarm Devices

An Alarm System consisting of an active telephone system and warning alarm (e.g. siren) shall be established by Contractor to alert workers and fire department in case of fire emergency.

#### 8.2 SAFE EMERGENCY EGRESS

##### 8.2.1 Application

This part contains general fundamental requirements essential to providing a safe means of egress from fire and similar emergencies. Nothing in this part shall be construed to prohibit a better type of containment construction, more exits, or otherwise safer conditions than the minimum requirements specified in this part.

##### 8.2.2 Fire Alarm Facilities

- A. In each work area, provide fire alarm facilities to workers and other building occupants so they may escape.
- B. These fire alarm facilities shall be provided where necessary to warn worker and building occupants of the existence of fire, as a fire itself may not provide adequate warning.

### **8.2.3 Protection of Workers and Building Occupants**

- A. No existing building shall be occupied during demolition/abatement unless all existing exits and any existing fire protection are continuously maintained, or in lieu thereof, other measures are taken to provide equivalent safety.
- B. No flammable or explosive substances or equipment for demolition/abatement shall be introduced in a building of normally low or ordinary hazard classification while building is occupied, provided the condition of use and safeguards do not create any additional danger or handicap to egress beyond the normally permissible conditions in the building or work area.
- C. Each exit, way of approach, and way of travel from an exit to the street or open space shall be continuously maintained free of all obstruction or impediments to instant use in the case of fire or other emergency.

## **8.3 MEANS OF EGRESS**

### **8.3.1 Definitions**

- A. Exit Access: That portion of a means of egress that leads to an entrance to an exit.
- B. An Exit: That portion of a means of egress that is separated from all other spaces of demolition /abatement or equipment as a way of travel to the street or open area.
- C. High Hazard Contents: High hazard contents shall be classified as those materials, substances, or equipment that are able to rapidly burn or from which toxic gases, fumes, or explosions may occur in the event of fire.

### **8.3.2 Means of Egress**

- A. If a door is present at the exit to the decontamination unit, from a work area to an exit, or to a way of exit access, it shall be of the side-hinged, swinging type. It shall swing in the direction of exit travel.
- B. The minimum width of any way of exit access shall in no case be less than 28 inches. Where a single way of exit access leads to an exit, its capacity in terms of width shall be at least equal to the required capacity of the exit to which it leads. Where more than one way of exit access leads to an exit, each shall have a width adequate for the number of persons it must accommodate.

### **8.3.3 Emergency Exits**

- A. For each work area, Contractor shall provide an alternate emergency exit.
- B. The alternate emergency exit shall consist of a door that leads to a way of exit access. The door shall be covered and sealed with fire-retardant polyethylene sheeting.
- C. Fire-retardant polyethylene sheeting covering the emergency exit shall be clearly outlined and attached in a manner that allows "tear away" in case of emergency and marked as an emergency exit. A utility knife shall be permanently attached to the fire-retardant polyethylene sheeting to provide access to the emergency exit.
- D. Contractor shall install arrows throughout the work area at 2 feet and 5 feet above the floor indicating the direction to the nearest exit.

### **8.3.4 Emergency Lighting**

- A. In case of electrical failure during fire, Contractor shall provide battery-operated lights or lamps in the work area.
- B. There shall be at least one battery-operated light or lamp for every five workers present in the work area.



**SECTION 02 83 00  
LEAD ABATEMENT**

**SUB-SECTION 01  
GENERAL LEAD REMOVAL SPECIFICATIONS**

**1.0 GENERAL**

**1.1 Description**

- A. This section consists of furnishing all work necessary to perform the removal, packaging, handling, transportation, and disposal of lead-containing materials and lead-contaminated materials located within the project limits. All work shall be performed in accordance with all federal, state, and local requirements and statutes.
- B. The work specified herein shall be the removal of lead-containing materials by persons knowledgeable, qualified, and trained in the removal, treatment, handling, packaging, transportation, and disposal of lead-containing materials, and the subsequent cleaning of the affected environment. These persons shall comply with all federal, state and local regulations and mandated work practices, and shall be capable of performing the work in the Contract.

**1.2 Scope of Work**

- A. General Requirements: Work of this section includes, but is not limited to, the following:
  - 1. See the attached appendix entitled Lead Abatement Scope of Work
  - 2. Providing dust control as required to protect the Contractor's employees, Owner Staff, visitors/guests, and passers-by from lead exposure. The lead concentration in the air outside of the lead work control area but inside of the work area (inside of the construction fence) shall not exceed 10 micrograms per cubic meter ( $\mu\text{g}/\text{m}^3$ ). The airborne lead concentration outside of the work area shall not exceed the background airborne lead concentration as tested by the HazMat Project Manager (HPM) prior to the commencement of any on-site activity.
  - 3. The work includes protecting the site (specifically the soil surrounding the building and landscaping), the building structure, facility, any and all furniture, fixtures, etc., from further lead contamination.
  - 4. The Contractor shall perform employee exposure monitoring as required by Cal-OSHA during the project
- B. The following precautions should be taken prior to initiating demolition activities involving any lead-containing material.
  - 1. The Contractor shall not perform any lead-related demolition activities until an initial exposure assessment has been performed and submitted to the Owner's Representative.
  - 2. The Contractor shall install lead dust control measures, lead waste and debris retention areas, worker protection, and decontamination areas in accordance with this Section, the Contractor's work plan, and lead exposure assessment data.
- C. Pre-Project Initial Exposure Assessment and Test Section: Prior to performing any lead-related demolition work, the Contractor shall perform an initial exposure assessment as described in 8 CCR 1532.1. The initial exposure assessment shall be performed through the preparation of "Lead-Related Construction Demolition Test Sections", if deemed necessary. The Test Section work shall be performed a minimum of two weeks prior to initiating lead-related demolition work at the building. During work on the Test Section, all Supervisors/Competent Persons shall

be certified as Lead-Related Construction Supervisors and all workers shall be certified as Lead-Related Construction Workers in accordance with 17 CCR, Division 1, Chapter 8.

- D. Lead-Related Demolition Scope of Work: The Contractor shall remove, package, transport, and properly dispose of the lead-containing and lead-contaminated items referred to in Appendix A for specific locations. Quantities shall be field verified.
- E. Where exterior lead containing material is encountered:
1. Remove or protect bushes and landscaping from the perimeter of the building out to 15 feet from the base of the buildings as required for soil protection. When necessary, cut the bushes and landscaping flush with the ground. Dispose of the bushes and landscaping as construction debris following removal.
  2. Remove, package, transport, and properly dispose of all lead-containing painted exterior components on the Buildings including but not limited to exterior wood cladding (siding), door components, window components, fascia boards and roof overhang components. Remove, package, transport, and properly dispose of the lead-containing window glazing located on the Buildings. Remove, package, transport, and properly dispose of all lead-containing painted interior doors in the Buildings. The Owner may have performed waste characterization sampling of these items. If not the contractor shall be responsible for the same. All work associated with the removal of the exterior components and interior doors shall be performed in accordance with this Section, the Contractor's lead-related demolition work plan, and the procedures utilized during the Test Section work.
  3. Remove, package, transport, and properly dispose of all lead-containing painted components located on the interior of Buildings. These components include, but are not limited to, gypsum wall and ceiling board systems, wood wallboard, wood base cove, and interior door frame components. The Owner may have performed waste characterization sampling of these items. If not the contractor shall be responsible for the same. All work associated with the removal of the exterior components and interior doors shall be performed in accordance with this Section, the Contractor's lead-related demolition work plan required by Article 1.08, and the procedures utilized during the Test Section work.
  4. The Owner has sampled the soil around the perimeter of the buildings. The Contractor is responsible for protecting the soil on the perimeter of the building from becoming contaminated with lead in excess of 350 ppm or established 'baseline' levels – which ever is lower. After completion of the lead-related demolition work the Owner will again sample the soil. The testing and analysis of the soil samples will require five to eight working days to complete. If the lead concentration in the soil exceeds 350 ppm, or established 'baseline' levels – which ever is lower, the Contractor shall perform the following work at no additional cost to the Owner.
    - a. The Contractor shall remove the top six inches of soil from the base of the building/ point of work to a minimum distance of ten feet from the point of work and extending out to the perimeter of the work area. The contractor shall perform the removal of the soil in two days or less.
    - b. The waste soil shall be packaged and placed into waste containers in accordance with the requirement of the waste transporter and disposal facility.
    - c. The contractor shall retain the HazMat Project Manager that was on-site during the lead-related demolition project to perform perimeter air monitoring.
    - d. At the completion of the soil removal project, the HazMat Project Manager will collect representative waste characterization samples of the soil waste. The soil waste samples will be evaluated for their conformance with the requirements of Title 22 and the requirements of the waste transporter and disposal facility.

- e. The testing and analysis of the soil waste characterization samples will require five to eight business days to complete. The Contractor shall leave the waste containers on the project site until receipt of the waste sample characterization sample results.

**1.3 Related Work**

SECTION 02 82 13 – ASBESTOS RELATED DEMOLITION WORK

**1.4 Required Licensure and Certification**

- A. Licensure – For all Contractor(s) or Sub-Contractor(s) involved in any facet of lead related work enumerated as part of this project the following license(s) shall be current and be maintained in current status throughout the duration of the project.
  - a. A copy of the current California Contractors State License Board (CSLB) License (minimum requirement is a Class B license or a Class C license) for any **and**
  - b. US EPA Certification under the Toxic Substances Control Act (TSCA) Section 402 Repair, Renovation and Painting activities (RRP) pursuant to 40 CFR Part 745.89.

Contractors having endorsements, riders or qualifiers on any of their licenses such as (but not limited to) ‘for bidding purposes only’ etc. are ineligible to perform work as part of this contract.

- B. Transportation of Lead-Containing Materials: Contractor shall be a registered hazardous waste transporter with State of California, Department of Toxic Substances Control. If the Contractor is not a registered hazardous waste transporter, the Contractor shall have a listed subcontractor that is a registered hazardous waste transporter with State of California, Department of Toxic Substances Control. Copies of the current, relevant registration certificate(s) shall be submitted as a part of the pre-job submittal.

Throughout the duration of the project, all Supervisors/Competent Persons shall be certified as Lead-Related Construction Supervisors and all workers shall be certified as Lead-Related Construction Workers in accordance with 17 CCR, Division 1, Chapter 8.

**1.5 Applicable Documents and Regulations**

- A. It is the responsibility of the Contractor to know the current regulations controlling work and to perform all project related work in accordance with such regulations that provide for worker and public safety against lead exposure.
- B. The publications listed below form a part of this specification to the extent referenced. The current issue of each document shall govern. Where conflict among requirements or with these Specifications exists, the more stringent requirements shall apply. The publications are referenced in the text by basic designation only.

CODE OF FEDERAL REGULATIONS (CFR)

29 CFR Part 1910	Occupational Safety and Health Standards for General Industry
29 CFR Part 1910.134	Respiratory Protection
29 CFR Part 1926	Occupational Safety and Health Regulations for Construction
29 CFR Part 1926.62	Lead

U.S. ENVIRONMENTAL PROTECTION AGENCY (EPA)

40 CFR Part 148	Hazardous Waste Injection Restrictions
40 CFR Part 260	Hazardous Waste Management Systems: General
40 CFR Part 261	Identification and Listing of Hazardous Waste
40 CFR Part 262	Standards Applicable to Generators of Hazardous Waste
40 CFR Part 263	Standards Applicable to Transporters of Hazardous Waste
40 CFR Part 264	Standards for Owners and Operators of Hazardous Waste Treatment, Storage, and Disposal Facilities

40 CFR Part 265 Interim Status Standards for Owners and Operators of Hazardous Waste Treatment, Storage, and Disposal Facilities  
40 CFR Part 268 Land Disposal Restrictions

NATIONAL FIRE PROTECTION ASSOCIATION (NFPA)

NFPA 701 (1989) Methods of Fire Test for Flame-Resistant Textiles and Films

NATIONAL INSTITUTE FOR OCCUPATIONAL SAFETY AND HEALTH (NIOSH)

NIOSH OSHA Booklet 3142 Lead in Construction

CALIFORNIA CODE OF REGULATIONS (CCR)

8 CCR Part 1532.1 Lead  
8 CCR Part 5194 Hazard Communication  
17 CCR, Div. 1, Cpt. 8 Accreditation, Certification, and Work Practices for Lead-Based Paint and Lead Hazards  
22 CCR, Div. 4, Cpt. 30 Hazardous Waste Handling  
26 CCR Part 3203 Illness and Injury Protection  
26 CCR Part 3220 Emergency Action Plan  
26 CCR Part 3221 Fire Prevention  
26 CCR Part 5144 Respiratory Protection

CALIFORNIA HEALTH AND SAFETY CODE Section 25157.8 (from AB 2784 Strom-Martin, 1998)

UNDERWRITERS LABORATORIES (UL)

UL 586 (1990) High-Efficiency, Particulate, Air Filter Units

CALIFORNIA LABOR CODE

Section 6501.5-6505.5

ALL OTHER FEDERAL, STATE, COUNTY AND LOCAL CODES AND ORDINANCES AS APPLICABLE.

**1.6 Notifications and Permits**

- A. Contractor shall make all required written notifications or applications to regulatory agencies including the following:
1. California Division of Occupational Safety and Health (Cal-OSHA) -  
Lead Work Pre-Job Notification shall be accordance with 8 CCR Part 1532.1.  
California Department of Public Health (CDPH) Form CDPH 8551
  2. Local or facility agencies as applicable.

**1.7 Supervisor/Competent Person and Workers**

**All valid and current Supervisor/Competent Person and Workers documentation shall be physically present on site, prior to any lead related work being performed by that person. Failure to comply with this requirement shall render the person ineligible to work until the required documentation is available on site.**

- A. The Contractor shall have a California Department of Public Health (CDPH) Lead-Related Demolition Supervisor/Competent Person present at all times while work on this Contract is in progress. The Lead-Related Construction Supervisor/Competent Person shall possess the following training and certifications regardless of the results of the Test Section work. All certificates are to remain current and complete throughout the duration of the project.

- B. The Lead-Related Demolition Supervisor/Competent Person shall have successfully training meeting the requirements of 8 CCR Part 1532.1 and 17 CCR, Division 1, Chapter 8. Training shall be provided prior to the time of job assignment and, at least, annually. The Supervisor/Competent Person shall be thoroughly familiar and experienced with lead removal and related work, and shall be familiar with and enforce the use of all safety procedures and equipment. He/she shall be knowledgeable of all EPA, OSHA, and NIOSH requirements and guidelines. Additionally, the Supervisor/Competent Person shall be certified as a Lead-Related Construction Supervisors in accordance with 17 CCR, Division 1, Chapter 8.
- C. Throughout the duration of the project, including during work on the Test Section, all workers shall have received training in accordance with 8 CCR Part 1532.1 and 17 CCR, Division 1, Chapter 8. The training shall be provided prior to the time of job commencement and, at least, annually. Additionally, all workers performing work shall be certified as Lead-Related Construction Workers in accordance with 17 CCR, Division 1, Chapter 8. All certificates are to remain current throughout the duration of the project. Throughout the duration of the project the lead-related worker training and certification requirements listed below will be required. The Contractor shall submit documentation that the workers have received the training. The training shall be for a minimum of eight hours. Worker training including the following information is required at a minimum. All certificates are to remain current and complete throughout the duration of the project.
1. An employee's right to access to records under 29 CFR Part 1910.1020.
  2. The contents and requirements of 29 CFR Part 1926.62 and 8 CCR 1532.1.
  3. The specific nature of the operation that could result in exposure to lead.
  4. The purpose, proper selection, fitting, use, and limitations of respirators.
  5. Purpose and description of the medical surveillance program and the medical removal protection program, including information concerning the adverse health affects associated with excessive exposure to lead (with particular attention to the adverse reproductive effects on both males and females and hazards to the fetus and additional precautions for employees who are pregnant).
  6. Relevant engineering controls and good work practices.
  7. The contents of any compliance plan in effect.
  8. Instructions that chelating agents should not routinely be used to remove lead from their bodies and should not be used at all except under the direction of a licensed physician.
- D. If the Contractors means and methods change from those presented in the lead-related demolition work plan and during the work of the Test Section, the Contractor shall perform another exposure assessment to determine the training requirements for the lead-related demolition workers.
- E. If the ongoing personal air monitoring performed by the Contractor indicates that the Action Level is being exceeded, the contractor shall provide lead-related demolition workers with the training and certifications required above.
- F. Current and complete documentation from a Physician that all employees or agents who may be exposed to airborne lead in excess of the action level have received a comprehensive medical examination as required by 29 CFR Part 1926.62 and 29 CFR Part 1910.1200 and will receive continued medical surveillance, including biological monitoring, as required by 29 CFR Part 1926.62 and 29 CFR Part 1910.1200 and by the state and local regulations pertaining to such work. Records shall be retained, at Contractor's expense, in accordance with 29 CFR Part 1910.1020. Biological monitoring is to include Blood Lead Level (BLL) and Zinc Protoporphyrin (ZPP). These tests

are to be performed not more than 30 calendar days PRIOR to the commencement of work and results be presented prior to the commencement of the removal of any lead containing materials. If the work schedule is phased, the tests are to be repeated prior to the commencement of each phase of work; unless the close of one phase, and the commencement of the next phase, are less than 30 calendar days apart.

- G. Current and complete documentation from a Physician that all employees or agents who may be exposed to airborne lead in excess of the action level have received medical monitoring in accordance with 29 CFR Part 1926.62 to determine whether they are physically capable of working while wearing the respirator required without suffering adverse health affects. The contractor must be aware of and provide information to the examining physician about unusual conditions in the workplace environment (e.g. high temperatures, humidity, and chemical contaminants) that may impact on the employee's ability to perform work activities.
- H. Current and complete documentation of respirator fit-testing, performed within the last twelve months, for all Contractor employees and agents who must enter the work area. This fit testing shall be in accordance with qualitative procedures as required by OSHA regulations or be quantitative in nature

## 1.8 Submittals

- A. Submit, as applicable, the following to the Owner's Representative for approval within Ten (10) days of receiving the "Notice to Proceed" or at least Ten (10) Working Days prior to the start of work. These submittals are in addition to those required in any other section(s) or sub-section(s) of these documents. This document shall be submitted by the contractor performing the work and not by any other. Include at the very least the following:
  - 1. Notifications. All notifications shall be current and valid throughout the duration of the project. Any material changes to the notification, i.e., the quantity of materials being removed, the physical materials being removed, the duration of the project, etc. shall require revisions to the regulatory agencies, with copies provided to the HPM on site. Copies of the written notification and confirmations at least to/from the following regulatory agencies will be required:
    - a. California Division of Occupational Safety and Health (Cal-OSHA) Lead Work Area Pre-Job Notification.
    - b. Notification to the California Department of Public Health (Form 8551).
  - 2. Waste Haulers – Copies of:
    - a. Identification of the Waste Hauler(s) for both Hazardous and Non-Hazardous Lead Waste for this Project.
    - b. California Department of Toxic Substances Control (DTSC) Waste Transporter registration for each Waste Hauler.
    - c. California Department of Motor Vehicles (DMV) Motor Carrier Permit for each Waste Hauler.
    - d. U.S. Department of Transportation (DOT) Registration and U.S. Environmental Protection Agency (EPA) acknowledgement of Notification of Hazardous Waste Activity for each Waste Hauler (*only required if waste is to be transported out of State*).
    - e. Statement indicating that all waste generated on this specific site shall be transported by/disposed of by licensed, insured and certified personnel/locations.
    - f. Statement that the types of Waste Containers being used for this Project will be accepted by the Waste Hauler(s) for the storage and transport of both Hazardous and Non-Hazardous Waste.
  - 3. Waste Disposal Facility - Landfill and/or Recycling Facility – Copies of:
    - a. Identification of the Landfill(s)/Recycler(s) to be used for the disposal of both Hazardous and Non-Hazardous Lead containing Waste generated at the Project site.
    - b. Permits for the Landfill(s)/Recycler(s) to be used for the disposal of both Hazardous and Non-Hazardous Lead waste generated at the Project site.
    - c. Identification of the Types of Waste accepted at the Landfill(s)/Recycler(s).
    - d. Identification of the Types of Waste Profiling required by the Landfill(s)/Recycler(s).
    - e. Statement that the types of Waste Containers being used for this Project will be accepted by the Landfill(s)/Recycler(s) for both Hazardous and Non-Hazardous Waste.

4. Licensure – For all Contractor(s) or Sub-Contractor(s) involved in any facet of lead related work enumerated as part of this project the following license(s) shall be current and be maintained in current status throughout the duration of the project.
  - a. A copy of the current California Contractors State License Board (CSLB) License (minimum requirement is a Class B license or a Class C license) for any **and**
  - b. US EPA Certification under the Toxic Substances Control Act (TSCA) Section 402 Repair, Renovation and Painting activities (RRP) pursuant to 40 CFR Part 745.89.Contractors having endorsements, riders or qualifiers on any of their licenses such as (but not limited to) ‘for bidding purposes only’ etc. are ineligible to perform work as part of this contract.
5. Work Plan – A detailed written lead-related demolition work plan including, but not limited to, the following:
  - a. Identification of all Lead Scope of Work items and Trigger Tasks that are part of this Project, as well as, the Waste Streams the contractor anticipates generating during the course of performing the work listed in the Scope of Work;
  - b. Identification of entire Work Sequence (schedule) for this Project, including specifics of materials being removed/stabilized and the correlation between work areas and Types of Work (Lead, Asbestos, PCB, etc. as applicable);
  - c. Identification of abatement duration;
  - d. Identification of dust control measures;
  - e. Identification of work area preparation;
  - f. Identification of construction for decontamination enclosure systems;
  - g. Identification of demarcation protocols. i.e., installation of Lead barrier tape, barrier fence, Lead Work signage, etc.;
  - h. Identification of work area isolation protocols;
  - i. Identification of detailed specific Lead containing materials removal procedures;
  - j. Identification of Lead containing/contaminated debris clean-up and disposal procedures;
  - k. Identification of Personnel Protective Equipment (PPE) to be utilized as part of this project;
  - l. Identification of waste handling, storage and disposal procedures;
  - m. Identification of construction for chutes, (if required for this project).
6. HEPA vacuums, differential pressure air filtration devices and other local exhaust ventilation equipment. – Copies of:
  - a. Manufacturer's certification that HEPA vacuums, differential pressure air filtration devices, filters and other local exhaust ventilation equipment conforms to ANSI Z9.2-79.
  - b. Notification that required onsite testing has been scheduled for any and all differential pressure units, HEPA vacuum cleaners, etc. to ensure that the filtration efficiency meets the criteria for HEPA filtration devices, i.e., 99.97% efficiency at arresting mono-dispersed particulate matter greater than 0.03 micrometers in diameter.
8. SDS – The Contractor shall submit copies of the Safety Data Sheet, fire retardant certification or equivalent, in accordance with the OSHA Hazard Communication Standard (29 CFR 1910.1200) for each surfactant, encapsulating material, spray glue, mastic removal agent, plastic sheeting, adhesive/duct tape, etc. or other chemicals/products for use on this project, including the specific worker protective equipment proposed for use with the material indicated.
9. Personnel Documentation
  - a. Identification of the project’s Lead-Related Supervisor who is experienced in administration and supervision of lead-containing material demolition projects, including work practices, protective measures for building and personnel, disposal procedures, etc. including a legible photocopy of the California Department of Public Health (CDPH) Certified Lead Construction Supervisor’s card.
  - b. Current and complete documentation that the Contractor’s Lead-Related Construction Supervisor/Competent Person and Lead-Related Demolition Workers performing Lead-related demolition,

disposal, and air sampling operations have received training and are certified including a legible photocopies of the California Department of Public Health (CDPH) Certified Supervisor and Certified Lead Worker cards.

- c. Provide as part of the pre-job submittal a letter from the contractor, signed by a responsible and authorized officer of the contractor's company certifying the following – "This is to certify that all our personnel involved with affecting any lead containing or coated materials/surfaces are subject to current and valid medical monitoring in accordance with 29 CFR Part 1926.62 and 29 CFR Part 1910.1200 and that they will receive continued medical surveillance, including (a) the ability to work while wearing required respiratory protection without suffering adverse health affects and (b) biological monitoring [include Blood Lead Level (BLL) and Zinc Protoporphyrin (ZPP)], as required by 29 CFR Part 1926.62 and 29 CFR Part 1910.1200 and by all state and local regulations pertaining to such work. Furthermore, we certify that all relevant records shall remain valid and current throughout the project and that historical records will be retained by us, in accordance with 29 CFR Part 1910.1020." The contractor may issue this letter and identify and list (by name) all of their employees who will be on site for this project or, alternatively issue an individual letter per employee.
  - d. Current and complete documentation of respirator fit-testing for Contractor employees and agents who must enter the work area. This fit-testing shall be in accordance with qualitative procedures as required by OSHA regulations or be quantitative in nature
9. Respirators and Filters – Copies of Manufacturer's documentation and certification of NIOSH approvals for respiratory protective devices utilized on site, including manufacturer's certification of NIOSH approval of respirator cartridges (organic vapor, acid gas, mist, dust, high efficiency particulate) and High Efficiency Particulate Air (HEPA) filtration capabilities for all cartridges and filters.
  10. Testing Laboratory – Identification of the Independent Testing Laboratory (name, address, and telephone number) selected to perform analysis of personal air samples. Documentation shall be provided that the laboratory selected to perform the analyses is an EPA National Lead Laboratory Accreditation Program (NLLAP) accredited laboratory and is rated proficient in the NIOSH/EPA Environmental Lead Proficiency Analytical Testing Program (ELPAT), including accreditation for heavy metal analysis. The documentation shall list experience relevant to the analysis of lead in air and include a Quality Assurance and Quality Control Program. Currently, the American Association for Laboratory Accreditation (AALA) and the American Industrial Hygiene Association (AIHA) are the EPA recognized laboratory accreditation agencies. Documentation must also be provided that the laboratory is certified by the California Department of Public Health (CDPH).
  11. Site Specific Documentation – Copies of:
    - a. Identification of Work Area(s) at the site;
    - b. Identification of the nearest medical facility and route map/directions to the medical facility;
    - c. Emergency Contact Information and numbers for Emergency services as well as the contractors' emergency contact personnel and information;
    - d. Identification of on-site emergency meeting location;
    - e. Identification procedures for personnel accounting during an emergency.
  12. Contractor General Documents – Copies of:
    - a. General Injury & Illness Prevention Program in compliance with 26 CCR 3203.
    - b. General Emergency Action Plan in compliance with 26 CCR 3220.
    - c. General Fire Prevention Plan in compliance with 26 CCR 3221
    - d. Respiratory Protection Program in compliance with 26 CCR 5144.
- B. Hazardous Waste Manifests, Non-Hazardous Waste Data forms, trip tickets and disposal receipts for lead waste materials removed from the work area must be received within 24 hours of the transport.
- C. On-Site Documentation – Documents to be provided on-site throughout the duration of the project:



1. Provide on a DAILY basis, prior to the start of the shift, results from the personal air samples collected during the abatement process of the prior shift.
  2. Provide on a DAILY basis, prior to the start of the shift, copies of the containment entry log pertaining to the abatement process of the prior shift.
  3. Provide on a DAILY basis, prior to the start of the shift, copies of the Manometer logs pertaining to the abatement process of the prior shift.
  4. Copies of the Safety Data Sheets (SDS) for solvents, encapsulants, wetting agents, neutralizers, any other chemicals/products used on site and replacement materials, as necessary.
- D. Following completion of work on the Test Sections, submit to the Owner's Representative documentation that includes the following (the submittals required shall be submitted no later than five business days following completion of the Test Section work):
1. All personal air sampling performed by the contractor during the Test Section work. The personal air sampling results shall be provided as 8-hour TWA results.
  2. A description of the Trigger Tasks utilized during the Test Section work.
  3. Proposed changes in work procedures, if any, from those that were proposed in the original work plan.
- E. Upon completion of all lead-related demolition activities, submit to the Owner's Representative documentation that includes, without limitation, the following (the submittals required shall be submitted no later than 20 business days following the Contractor's demobilization from the project site):
1. Work area entry/exit logbook. The logbook must record name, affiliation, time in, and time out for each entry into the work site.
  2. The log of manometer readings showing the pressure differential maintained throughout the project.
  3. OSHA, Cal-OSHA, California Department of Public Health (CDPH) required personal exposure air monitoring results.
  4. Post project Biological monitoring for each employee who has worked at the site during any phase of lead related work is to include Blood Lead Level (BLL) and Zinc Protoporphyrin (ZPP). These tests are to be performed not more than 7 calendar days AFTER the conclusion of work
  5. Accident/incident reports where injury or damage has occurred on or to the Owner's property.
  6. Hazardous waste manifests, non-hazardous waste data forms, trip tickets and disposal receipts for lead waste materials removed from the work area within 24 hours of the transport.

## 1.9 Notices and Postings

- A. Post in the wash station/decontamination station, a list containing the names, addresses, and telephone numbers of the Contractor, Owner Representative, HazMat Project Manager, and emergency contact numbers.
- B. Post at the job site a list of persons authorized to enter the lead-related demolition work area.
- C. Additional postings shall include:
  1. Visitor entry and exit log.
  2. Employee daily sign in/out log.
  3. Work area entry and exit procedures.
  4. Emergency procedures.

- D. One copy of Cal-OSHA and Department of Health Services regulations.
- E. Posted Warnings and Notices: The following regulations, warnings, and notices shall be posted at the work site in accordance with 29 CFR Part 1926.62 and 8 CCR Part 1532.1.
  - 1. Warning Signs and Labels: Warning signs shall be provided at building entrances and approaches to lead work control areas containing airborne lead debris. Signs shall be located at a sufficient distance from the lead work control areas that will allow personnel to read the sign and take the necessary protective actions required before entering the lead work control area.
  - 2. Post at least two (2) safety warning signs, in English and Spanish, which follow the “Sample Format Warning Sign” shown below:

Sample Format Warning Sign  
 Minimum Size – “24” x 36”  
 Material – Aluminum or Fiberglass  
 Script:

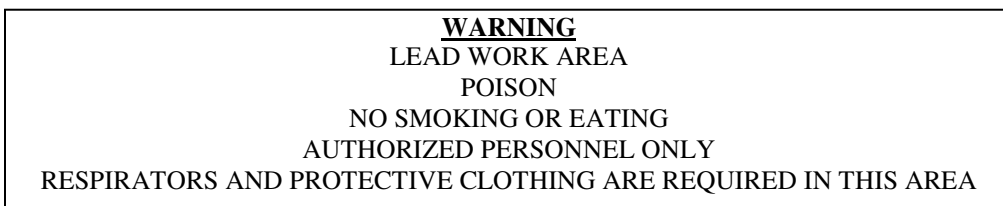

- F. Posting required by local, state and federal agencies exercising jurisdiction over the work area. These are to include, but not be limited to, warning notices, notices of proposed work activity, copies of notifications to local and state agencies, etc.

**1.10 Work Area Security**

- A. The lead work control area shall be restricted only to authorized personnel, including Contractor, Contractor's employees, Owner’s Representative(s), and federal, state, and local inspectors.
- B. Entry into the lead work control area by unauthorized individuals shall be reported immediately to the Owner’s Representative.
- C. Contractor shall be responsible for Project site security during lead-related demolition operations in order to protect work efforts and equipment.

**1.11 Personal Protection and Safety**

- A. The Contractor alone shall be responsible for the safety, efficiency, and adequacy of his/her appliances, methods, and for any damages that may result from his/her operations, improper construction practices, or maintenance. He shall erect and properly maintain at all times as required by the conditions and progress of the work, proper safeguards for the protection of workmen and the public and shall post warning signs around the job site and at any and all entrances / entryways to the work area(s).
- B. Work shall be performed in accordance with the requirements of applicable regulations including, but not limited to 29 CFR Part 1926.62, 8 CCR Part 1532.1, and 17 CCR, Division 1, Chapter 8. Matters of interpretation of the standards shall be submitted to the appropriate agency for resolution before starting work. Where these

requirements vary or conflict, the most stringent shall apply. In the event that work practice variances are granted by the governmental agency having jurisdiction over the work, these variances will be forwarded to the Owner and/or the Owner's representative as soon as the variance has been issued. A copy of the variance must also be posted at the entryway to the work area or if this is not possible, in a prominent place.

C. Respiratory Protection Requirements: A respiratory protection program shall be established as required by 29 CFR Part 1926.103 and 29 CFR Part 1926.62 and in accordance with 29 CFR Part 1910.134. An approved respirator shall be furnished to each employee and visitor required to enter a lead work control area. A fit test shall be conducted in accordance with 29 CFR Part 1926.62.

1. Air-purifying respirators shall be approved by NIOSH for use with dust, fumes, and mists having permissible exposure limits less than 0.005 milligrams per cubic meter (i.e., have P-100 filters) and for other hazardous airborne contaminants that may be encountered, as determined by the Competent Person. Respirators shall comply with the requirements of 29 CFR Part 1926.62 and shall be used in accordance with 29 CFR Part 1926.103, and 29 CFR Part 1910.134.
2. A sufficient supply of respirator filters shall be maintained at the work site to provide new filters to employees, Owner Employees, authorized visitors, and government regulator personnel throughout the duration of the project. Filters shall be replaced according to the manufacturer's recommendations, when breathing becomes difficult, or if the filter becomes wet. At any time during on-site work activity, the contractor shall maintain on-site and readily accessible three (3) new respirators, one in each size, small, medium and large along with the requisite filters/cartridges for the type of work being performed. These respirators will be kept in readiness for the Owner/Owner's representative or any governmental agency representative having jurisdiction over the project.

Additionally, the contractor shall make available to HPM two (2) sets of new North™ 7700 Series Respirator Filter Cartridges throughout the duration of the project. These filter cartridges shall be appropriate to the work being conducted on site i.e., P100 HEPA cartridge and/or stacked P100 HEPA + Organic Vapor cartridge, etc.

3. Respirators shall be fit-tested utilizing irritant smoke or isoamyl acetate a minimum of every 6-12 months. Either the standard Irritant Smoke Protocol or Isoamyl Acetate Protocol may be used.

D. A Hazard Communication Program shall be implemented in accordance with 29 CFR Part 1926.59.

E. The Contractor, the HazMat Project Manager, and the Owner's Representative shall arrange and hold a preparatory inspection meeting immediately prior to beginning the Test Section, following completion of the Test Sections to discuss the results, following completion of the waste characterization sampling and analysis, and prior to beginning the lead-related demolition work.

F. Right-to-know notices shall be placed in clearly visible areas of the work site in compliance with Federal, State, and local regulations.

G. Daily personnel air monitoring results shall be placed in a clearly visible area of the work site and shall be prepared so as to be easily understood by the workers.

H. A list of emergency telephone numbers shall be posted at the site. The list shall include numbers of the local hospital, poison control center, police and fire departments, Government, Contractor, and Owner representatives who can be reached 24 hours per day, and professional consultants directly involved in the project.

I. Sufficient quantities of health and safety equipment and supplies as required by 29 CFR Part 1926.62 and 8 CCR Part 1532.1, and other materials and equipment needed to complete the project, shall be available and kept on site. Specific health and safety equipment to be utilized at all times during performance of lead-related demolition work includes the following.

1. Disposable full body suits. The disposable full body suits shall have head and foot covers and shall be of a sufficient size to prevent tearing during performance of the work.
  2. Disposable rubber gloves.
  3. Hard hats.
  4. Safety shoes or boots.
  5. Eye and hearing protection.
- J. A wash/decontamination station shall be provided on the site at all times that lead-related demolition work is being performed.

### **1.12 Hazmat Project Manager Services**

- A. The Owner has contracted with the HazMat Project Manager (HPM) to perform contractor and project monitoring services including the following:
1. Collect side-by-side Contractor employee exposure air samples during the lead-related demolition work.
  2. Collect perimeter air samples during the lead-related demolition work.
  3. Collect waste characterization samples during the lead-related demolition work.
- B. Stop Work Orders. The HPM will stop work in the following situations:
1. If the airborne lead concentration exceeds  $10 \mu\text{g}/\text{m}^3$  outside the lead-related demolition work area but inside the construction zone.
  2. If the airborne lead concentration outside of the lead-related demolition work area exceeds background levels established before the commencement of work.
  3. If the Contractors means and methods change, work will be stopped to establish a new exposure assessment.
  4. If personal air monitoring indicates that new respiratory protection is required.
  5. If the written specifications are being violated or if the owner issued instructions are being circumvented.

**SUB-SECTION 02  
MATERIALS AND EQUIPMENT**

**2.0 MATERIALS and EQUIPMENT**

**2.1 Materials**

A. General: Contractor shall adhere to the following:

1. All plastic, spray-on strippable coatings, electrical equipment, mechanical equipment and structural materials used shall be UL-certified as fire retardant or non-combustible.
2. Deliver all materials in the original packages, containers, or bundles bearing the name of the manufacturer, brand name (where applicable), and model.
3. Polyethylene sheeting utilized for worker decontamination and barriers shall be black or opaque in color and shall be a minimum of 6-mil in thickness. All polyethylene shall be fire retardant.
4. Waste containers utilized during the project shall be properly labeled as required by 29 CFR Part 1926.62, 8 CCR Part 1532.1, and, if applicable, 22 CCR 66504.
5. Warning signs as required by 8 CCR Part 1532.1 and 29 CFR 1926.62 shall be utilized during lead-related demolition activities.
6. PVC Safety/Barrier Fence (minimum of 4' high) to isolate the work area shall be utilized during any lead-related activities.

**2.2 Equipment**

A. General:

1. HEPA vacuums equipped with HEPA filtration and operated in accordance with ANSI Z9.2-79.
2. Differential pressure (negative pressure) air filtration devices and other local exhaust ventilation equipment conform to ANSI Z9.2-79. On site testing will be required for any and all differential pressure units, HEPA vacuum cleaners, etc. to ensure that the filtration efficiency meets the criteria for HEPA filtration devices, i.e., 99.97% efficiency at arresting monodispersed particulate matter greater than 0.03 micrometers in diameter.
3. Respirators shall be furnished to the workers by the Contractor. The respirators shall have been tested and approved by National Institute of Occupational Safety and Health (NIOSH) for use in lead contaminated atmospheres. Respirator usage during the project shall be determined by the results of the sampling and analysis performed during the Test Section and shall be in accordance with the requirements of 8 CCR 1532.1 and the work plan submitted by the Contractor. The respiratory requirements below shall be utilized at a minimum:
  - a. Half-face air purifying respirators equipped with P-100 filters at a minimum shall be utilized during the Test Section Work.
  - b. If the Test Section work, or periodic personal monitoring indicates that the airborne lead concentration will exceed the Action Level, the Contractor shall utilize respiratory protection as indicated by the actual airborne lead concentration.
  - c. If the Test Section work indicates that the airborne lead concentration will not exceed the Action Level, the

Contractor at his discretion may downgrade the respiratory requirements for the project. The minimum permissible respiratory protection throughout the project, permitted by these specifications is a half-face (half-mask) negative pressure respirator equipped with P-100 respirator. This minimum standard shall be adhered to even in the event that the Test Phase of the project determines that respiratory protection is not required. This supercedes any and all instructions to the contrary that may be found in these documents.

4. Contractor shall provide full body disposable protective clothing, including head, body, and foot coverings to workers and visitors in sizes adequate to accommodate movement without tearing. Full body disposable protective clothing shall be utilized at all times during lead-related demolition activities.
5. Additional safety equipment (e.g. hard hats meeting the requirements of ANSI Standard Z89.1-1981, eye protection meeting the requirements of ANSI Standard Z87.1-1979, safety shoes meeting the requirements of ANSI Standard Z41.1-1967, disposable gloves), as necessary, shall be furnished to all workers and authorized visitors. This safety equipment shall be utilized at all times during lead-related demolition activities.
6. Non-skid footwear shall be furnished to all workers. Disposable clothing shall be adequately sealed to the footwear to prevent body contamination.
7. Furnish disposable mops, rags, and sponges for work area decontamination.

B. Removal:

1. Scaffolds, ladders, lifts, and hand tools (e.g., scrapers, wire cutters, brushes, utility knives, wire saws, etc.) shall be furnished as needed.
2. Rubber dustpans and rubber squeegees shall be furnished for cleanup.
3. Brushes utilized for removing loose lead-containing materials shall have nylon or fiber bristles. Metal bristles shall not be utilized.

**SUB-SECTION 03  
EXECUTION**

**3.0 EXECUTION**

**3.1 Lead-Containing Material Removal Preparation**

A. Exterior Lead-Related Demolition Work Area Preparation:

1. Prepare a lead work control area by placing 4' high PVC Safety/Barrier Fence and lead warning tape and proper signage around the area where work will be performed. The PVC Safety/Barrier Fence and warning tape should be placed a sufficient distance away from the removal area to allow persons who are not properly trained or who are not wearing personal protective equipment to avoid the work/contaminated area.
2. Install remote worker decontamination unit described in Article 3.2 or as agreed upon with the Owner's HPM.
3. Lead Workers shall don personnel protective equipment as required in Article 2.2.
4. Place one layer of 6-mil polyethylene sheeting on the ground as close as possible to the foundation, or the exterior floors (i.e., deck or porch) when applicable.
5. Extend plastic sheeting a minimum of ten feet out from the foundation.
6. Weight down the polyethylene sheeting at the foundation, and along all edges and seams.
7. The Contractor shall take extra care when performing exterior lead-related demolition on days when the constant wind speed is 15 mile per hour or over. If the removal procedure is producing dry waste in which visible movement along polyethylene sheeting is evident or if dust or debris is present outside of the lead work control area, the Contractor shall change the methods used for dust control to eliminate the problem. In any event, when visible emissions from the work activity are observed crossing the property line/ work area perimeter, all removal work will cease immediately. The contractor will implement emergency dust control measures and work shall not recommence until permission is granted by the Hazardous Project Monitor.
8. Perform lead removal in accordance with Article 3.06 – Lead-Related Demolition.

B. Interior Lead-Related Demolition Work Area Preparation:

1. Prepare a lead work control area by placing 4' high PVC Safety/Barrier Fence and lead warning tape and proper signage around the area where work will be performed. The PVC Safety/Barrier Fence and warning tape should be placed a sufficient distance away from the removal area to allow persons who are not properly trained or who are not wearing personal protective equipment to avoid the work/contaminated area.
2. Install remote worker decontamination unit described in Article 3.2 or as agreed upon with the Owner's HPM.
3. Lead Workers shall don personnel protective equipment as required in Article 2.2.
4. Place one layer of 6-mil polyethylene sheeting over all critical barriers including HVAC vents, windows, doorways, and corridor openings.
5. Place a drop cloth constructed of one layer of 6-mil polyethylene sheeting in all areas where interior lead-related demolition is to be performed. This drop cloth is to be sized and affixed in such a manner as to prevent any dust and debris landing on it from escaping. Precautions must be taken to prevent slips, trips and falls of personnel walking on this plastic surface.
6. A pressure differential system may be required, refer to the scope of work attached and/or consult with the HPM. If required, the pressure differential system shall produce a minimum of four filtered air changes per hour in the contained work area (work area to include a wood chipper and/or dumpster) and maintains a pressure differential of 0.02-inch water gauge between the inside and outside of the work area on a continuous basis.
7. Perform lead-containing material removal in accordance with Article 3.6 – Lead-Related Demolition.

C. Wood Chipper: The following procedures shall be utilized if a wood chipper is proposed to be used by the Contractor:

1. Construct a contained work area around the wood chipper and waste dumpster. The contained work area shall

be constructed of two layers of 6-mil polyethylene sheeting that is mechanically supported.

2. Install worker decontamination unit described in Article 3.2 or as agreed upon with the Owner's HPM.
3. Lead Workers shall don personnel protective equipment as required in Article 2.2.
4. A pressure differential system shall be established that produces a minimum of four filtered air changes per hour in the contained work area (including the wood chipper and dumpster) and maintains a pressure differential of 0.02-inch water gauge between the inside and outside of the work area.
5. Perform lead-containing material removal in accordance with Article 3.6 – Lead-Related Demolition.

### **3.2 Remote Worker Decontamination Systems**

- A. A minimum of one three-stage decontamination system is required to be operational on the site at all times that lead-related demolition is being performed. The decontamination system shall comply with the following requirements.
1. Worker decontamination enclosure systems shall be provided at a location near or adjacent to the lead work control areas. As a minimum, one system at a single location is required.
  2. Worker decontamination enclosure systems constructed at the Project site shall utilize 6-mil black or opaque polyethylene sheeting, or other approved materials for privacy.
  3. The personnel decontamination unit shall not be located inside the work area unless otherwise authorized by the Owner's HPM.
  4. The worker decontamination enclosure system shall consist of at least a clean room, a shower room and an equipment room, each separated from the other and from the work area by flaps comprised of three sheets of 6-mil polyethylene sheeting.
  5. Clean rooms shall be sized to adequately accommodate the work crew. Space for storing respirators shall be provided in this area. Clean work clothes; clean disposable clothing, replacement filters for respirators, towels and other necessary items shall be provided in adequate supply at the clean room. Posting of notices shall also be in this area or in an area immediately adjacent to the clean room. Postings shall be sited in a manner to ensure line of site visibility prior to approaching/entering the clean room.
  6. Shower rooms shall contain at least a Hudson sprayer for washing the workers hands, face, and respirator. The shower enclosure shall be constructed to ensure against leakage of any kind. Shower water shall be drained, collected and either filtered through a system with at least 0.5-1.0 micron particle sizes collection capability or disposed of as contaminated waste. Additionally, the contractor and their personnel shall make themselves conversant of the requirements of any local water pollution agency or municipal waste water treatment agency prior to discharging any filtered or treated waste water. In no event shall the waste water be discharged without adequate filtration.

### **3.3 Maintenance of Construction/Lead-Related Work Area Barriers**

At any time during the lead related work activities after barriers have been erected, if visible material is observed outside of the work area or if damage occurs to barriers, work shall immediately stop, repairs made to barriers, and debris/residue cleaned up using appropriate procedures. In addition, the barriers shall be moved farther away from the lead-related work area.



### **3.4 Commencement of Work Shall Not Occur Until**

- A. Test Section: Work on the Test Section shall not occur until the following items have been completed.
  - 1. Pre-work submissions, notifications, and permits required and submittals have been provided and approved by the Owner's Representative.
  - 2. Construction and lead work control area barriers are in place.
  - 3. At least one wash station/decontamination station is operational.
- B. Interior Work Areas: Work on the interior of the building shall not occur until the following items have been completed.
  - 1. The removal of the asbestos-containing floor tile and mastic has been completed.
  - 2. Results from the interior Test Section have been submitted and the work practices for the interior work have been approved by the Owner's Representative.
  - 3. Construction and lead work control area barriers are in place.
  - 4. At least one wash station/decontamination station is operational.
- C. Exterior Work Areas: Work on the exterior of the building shall not occur until the following items have been completed.
  - 1. The interior asbestos-related demolition has been completed.
  - 2. The interior lead-related demolition has been completed.
  - 3. Results from the exterior Test Section have been submitted and the work practices for the exterior work have been approved by the Owner's Representative.
  - 4. Construction and lead work control area barriers are in place.
  - 5. At least one wash station/decontamination station is operational.
- D. No work task shall be performed without an initial assessment.

### **3.5 Workplace Entry and Exit Procedures**

- A. General: The following procedures shall be followed prior to entrance into any lead-related work area:
  - 1. Personnel, before entering the lead-related work area, shall read and be familiar with posted regulations, personal protection requirements (including workplace entry and exit procedures), and emergency procedures.
  - 2. Personnel shall wear respirators, disposable coveralls, head covering, and foot covering. Hardhats, eye protection, and gloves shall also be utilized, as required. Clean protective clothing shall be provided and utilized by each person for each separate entry into the work area.
  - 3. To exit the work area, personnel shall proceed to the wash station/decontamination station where they shall remove protective equipment and deposit disposable clothing into appropriately labeled containers for disposal and wash their hands, face, and any other exposed portions of their body.

### 3.6 Lead-Related Demolition

#### A. General - REMOVAL OF LEAD CONTAINING COATINGS

1. The Contractor will be required to remove paints and coatings as identified in areas scheduled for demolition or architectural renovations, as applicable. Do not remove lead-containing coatings with a torch or flame, except as an unavoidable result of welding or torching operations.
2. Grinding/Cutting, Welding or Torching Operations: To the extent feasible, and to avoid direct grinding/cutting, welding, or torching on surfaces containing lead in concentrations greater than  $0.64 \mu\text{g}/\text{cm}^2$ , by manually or chemically removing all layers of the coating to a distance of:
  - For at least four inches (4") on ALL side from the point at which mechanical abrasion or grinding is proposed,
  - at least eighteen inches (18") on ALL side from the point at which heat is proposed to be applied. To prevent the vaporization of lead from the surrounding areas the contractor shall endeavor to keep these surrounding areas cool.
3. Removal of Surface Coatings with Power Tools: Where mechanical removal of surface coatings constitutes an Activity Level II activity, provide power tools with local HEPA exhaust or dust collection systems to capture the aerosolized lead.
4. Maintain all work area surfaces as free as practicable from accumulated dust or debris. Dry sweeping or use of compressed air to remove dust or debris is not permitted. Clean all equipment, tools and containment structures within regulated areas, at a minimum, with HEPA vacuums or wet methods.
5. Conduct operations to prevent injury to adjoining facilities, persons, motor vehicles, etc., as applicable. Prevent chemical cleaning agents from coming into contact with pedestrians, motor vehicles, landscaping, buildings, and other surfaces that could be injured or damaged by such contact. Do not spray or scrape outdoors during winds of sufficient force to spread cleaning agents to unprotected surfaces.
6. For areas where full abatement is not required, the Contractor shall ensure that the paint that remains on interior walls, ceilings or other area surfaces in areas of active work as applicable, shall be adhered to the substrate sufficiently to support eventual repainting. Paints that peel or loosen during wetting will become part of the scope of work scheduled for abatement.

In areas where substrate stabilization is called for, the contractor shall smoothen the edges from which paint has been removed (i.e., 'feather') and apply at least three (3) coats of a non-lead containing paint primer to the removed substrate plus at least two feet (in every direction) from the edges of the area of partial removal. The primer used for stabilization shall be suitable for application on the specific substrate. NOTE, THIS OPTION IS NOT AVAILABLE FOR IMPACT OR FRICTION SURFACES WHERE ALL LEAD CONTAINING MATERIALS ARE TO BE REMOVED IN THEIR ENTIRETY TO THE SUBSTRATE.

7. In areas where damaged or other asbestos-containing materials will be disturbed during lead paint abatement, the Contractor shall handle this material in accordance with specification Section 02 82 13. Removed asbestos materials shall be placed in two 6-mil disposal bags and fiber drums and disposed of as asbestos waste. Lead and asbestos wastes shall not be combined, where practical. Mixed debris containing both lead and asbestos needs to be disposed at a landfill licensed to accept both types of waste with proper manifests. Only personnel trained, certified and meeting all criteria of both the asbestos abatement specification (section 02 82 13) and the lead abatement specifications (section 02 83 00) shall be permitted to attempt any removal that impacts both these materials.
8. Non-paint waste items found on floors are to be separated out and disposed of or cleaned by the Contractor. Small pieces of debris, such as broken glass, paper, etc., may be disposed of with the lead paint. - Large

items, such as equipment, furnishing, etc., are to be cleaned by HEPA vacuuming at the same time as the floors and stored on-site as directed by the Owner.

9. Seal all floor openings and protect the floor with polyethylene drop cloths or other acceptable means to prevent contamination or damage to other building surfaces and finishes.
  10. Provide HEPA-filtered exhaust units for area ventilation during removal, minimum 1,500-cfm capacity per unit. Provide one unit for each 3,500-sq. ft. of floor space to be covered per workday. Units must be portable and placed in the vicinity of removal operations. Exhaust units outside building. Provide temporary shoring as necessary to support equipment and workers. Establish a minimum of 0.025 inches water gauge negative pressure between the work area and the adjacent areas, as applicable, measured at a location approved by the Environmental Consultant.
  11. Work areas may require full or partial scaffolding to allow for continued expiation of the facilities during the construction period. Segregate areas by erecting solid plywood platforms on movable scaffolding and erecting 2 layers of 6-mil polyethylene sheeting to the structure above for full isolation of the assembly.
  12. Shoveling, wet sweeping, and brushing may be used only where vacuuming or other equally effective methods have been tried and are found to be ineffective.
  13. The use of steam cleaning and compressed air removal methods is not permitted. Abrasive removal equipment shall be equipped with local HEPA exhausts or dust collectors.
  14. The use of abrasive mechanical cleaning will generally not be permitted, unless approved in advance by the Owner and the Environmental Consultant; this prohibition includes sanding discs, sand blasting, or other abrasive compounds.
  15. Strictly conform to the approved cleaning procedures as recommended by the product manufacturer. Should a modification to the cleaning method specified be proposed, submit the proposal in writing for consideration and review by the Owner and its representative. These individuals will have the right to ask for test samples before final approval. Any such modification or change shall be at no additional cost to the Owner.
  16. Begin cleaning only after all sample panels and other required submissions are approved and protective means and methods are in place.
  17. Where complete removal is required, finished work shall show no signs of stains, scratches, streaks, or runs of discoloration from use of cleaners. Leave all substrate surfaces neat and clean, including removal of all primers as well as surface coats. All surfaces should be uniformly cleaned.
- B. Interior Lead-Related Demolition: The Contractor shall utilize the following procedures in addition to those proposed during the Test Sections and in the lead-related demolition work plan required by Article 1.08 when performing lead-related demolition on the interior of the building. Airborne lead concentrations outside the lead work control area but inside of the work area shall be kept below  $10 \mu\text{g}/\text{m}^3$ . Airborne lead concentrations outside of the work area shall be kept below the background level measured prior to the commencement of construction activities. If the airborne lead concentration outside of the lead work control area exceeds  $10 \mu\text{g}/\text{m}^3$  or if the airborne lead concentration outside of the work area exceeds background levels, then work shall cease and new engineering controls and work procedures shall be utilized.
1. Interior lead-related demolition shall be performed in a manner that reduces the amount of airborne lead particulate generated.
  2. While performing manual demolition, the material shall be kept wet to reduce airborne lead concentrations.

The material shall only be wetted to a point that dust control is maintained. The Contractor shall take care not to produce runoff or excess water waste. Waste generated during manual demolition shall not be allowed to dry out and shall be quickly packaged and placed into the waste containers required by the waste hauler and landfill.

3. If mechanical methods (power equipment) are used such as saws or grinders, this equipment should be used in a manner that reduces airborne lead concentrations. The area to be cut or ground shall be free of all lead coatings, paints, primers etc. PRIOR to cutting or grinding. The Contractor shall take care not to produce runoff or excess water waste. Waste generated during mechanical demolition shall not be allowed to dry out and shall be quickly packaged and placed into the waste containers required by the waste hauler and the landfill. The equipment shall be decontaminated prior to removing it from the lead work control area.
  4. If machinery/open flame is used to perform lead-related demolition, the lead-containing materials shall be pre-wetted and shall be kept continually wet during demolition. The area to be cut or ground shall be free of all lead coatings, paints, primers etc. PRIOR to using mechanical equipment or open flame. The Contractor shall take care not to produce runoff or excess water waste. Waste generated during mechanical/open flame demolition shall be quickly packaged and placed into the waste containers required by the waste hauler and the landfill. The machinery shall be decontaminated prior to removing it from the lead control work area.
- C. Exterior Lead-Related Demolition: The Contractor shall utilize the following procedures in addition to those proposed during the Test Sections and in the lead-related demolition work plan when performing lead-related demolition on the exterior of the building. Airborne lead concentrations outside the lead work control area but inside of the work area shall be kept below  $10 \mu\text{g}/\text{m}^3$ . Airborne lead concentrations outside of the work area shall be kept below the background level measured prior to the commencement of construction activities. If the airborne lead concentration outside of the lead work control area exceeds  $10 \mu\text{g}/\text{m}^3$  or if the airborne lead concentration outside of the work area exceeds background levels, then work shall cease and new engineering controls and work procedures shall be utilized.
1. Exterior lead-related demolition shall be performed in a manner that reduces the amount of airborne lead particulate generated.
  2. While performing manual demolition, the material shall be kept wet to reduce airborne lead concentrations. The material shall only be wetted to a point that dust control is maintained. The Contractor shall take care not to produce runoff or excess water waste. Waste generated during manual demolition shall not be allowed to dry out and shall be quickly packaged and placed into the waste containers required by the waste hauler and landfill.
  3. If mechanical methods (power equipment) are used such as saws or grinders, this equipment should be used in a manner that reduces airborne lead concentrations. The area to be cut or ground shall be free of all lead coatings, paints, primers etc. PRIOR to cutting or grinding. The Contractor shall take care not to produce runoff or excess water waste. Waste generated during mechanical demolition shall not be allowed to dry out and shall be quickly packaged and placed into the waste containers required by the waste hauler and the landfill. The equipment shall be decontaminated prior to removing it from the lead work control area.
  4. If machinery/open flame is used to perform lead-related demolition, the lead-containing materials shall be pre-wetted and shall be kept continually wet during demolition. The area to be cut or ground shall be free of all lead coatings, paints, primers etc. PRIOR to using mechanical equipment or open flame. The Contractor shall take care not to produce runoff or excess water waste. Waste generated during mechanical/open flame demolition shall be quickly packaged and placed into the waste containers required by the waste hauler and the landfill. The machinery shall be decontaminated prior to removing it from the lead control work area.

### 3.7 Lead Work Area Clean Up Procedure

- A. Maintain surfaces within the lead work control area free of accumulations of lead debris and dust. Restrict the spread of dust and debris. Keep waste from being distributed over the work area. Do not dry sweep or use

compressed air to clean up the area. When the lead removal operation has been completed, clean the area of visible lead contamination by vacuuming with a HEPA filtered vacuum cleaner and/or wet mopping the area.

- B. Final Cleaning: After all lead-containing materials are removed; the Contractor shall clean any remaining items remaining inside of the building including wall support systems, roof support systems and the concrete slab to remove any "settled" lead dust/debris. The wall and deck support systems shall be wet wiped using towels, rags, and sponges. The concrete slab shall be HEPA vacuumed and then mopped with plain water. The following procedures shall be used:
1. Wash all surfaces in the work area with a solution containing 5 percent tri-sodium phosphate (TSP) or equivalent. Prepare solution using hot water. Workers shall use towels, sponges, and mops to clean all surfaces including all areas that had been covered with polyethylene sheeting. Cleaning shall start at the ceiling and work down to the floors. A new solution of TSP/TSP Substitute and water shall be mixed as the water becomes dark or dirty.
  2. The floor will then be re-cleaned with plain water. If required by the Owner or the HPM, the floors could require 'neutralization' of any and all chemicals used. If this is to be performed, the neutralization will be carried out after the area has satisfied all clearance criteria.

### **3.8 Lead-Related Demolition Final Inspection**

- A. The Owner/HPM will perform a visual inspection of each lead work control area at the completion of each phase of lead-related demolition. The inspection will determine that all lead-containing dust and debris has been cleaned up and that all lead-containing materials have been removed, packaged, and placed into the proper waste containers. If the final visual inspection is not acceptable, the Contractor shall perform the cleanup procedures listed in Article 3.07 of this Section.
- B. The Owner/HPM will perform an inspection of the soil surrounding the building. No visible paint chips or lead-containing debris shall be present in the soil. If paint chips or debris are identified in the soil, the Contractor shall remove these using manual methods and HEPA vacuums.
- C. Final Inspection: Following completion of all phases of lead-related demolition, the Owner will perform a FINAL visual inspection of any items remaining in the work area including wall and deck support systems and the concrete slab.
1. All paint/lead containing waste is to be removed from work area by the end of each workday. Accumulated waste will not be allowed to remain in the area overnight. Plastic barriers, at entrances to the work areas, shall remain in place at all times until the area is scraped and cleared. Items requiring removal of lead-based paints intact shall be wrapped in one layer of polyethylene sheeting, sealed with duct tape and labeled properly prior to removal from the holding area.
  2. Visual Clearance Criteria for Lead Only Abatement Areas: At the end of each workday the HPM and the Contractor's Supervisor shall inspect work performed that day. If the visual inspection reveals that lead-contaminated wastes and loose debris have been adequately removed from the area, the Contractor will be allowed to commence work on the next work area. If the HPM determines that unacceptable waste and residue remain, the Contractor shall vacuum and re-clean those areas that are unsatisfactory. The Contractor will not be allowed to start removal in the next work area until the existing/current work area has passed a visual inspection.
  3. Wipe Sample Clearance, as deemed necessary by the HPM.
    - a. When the work is completed, the HPM will visually inspect the zone for any loose dust or debris, followed by wipe sampling of settled dust to document surface lead levels below the specified clearance levels.

Samples will be collected using commercial wipes moistened with a non-alcohol wetting agent. A one-foot square area will be wiped twice in an "S" pattern, the second pass being at right angles to the first, folding the wipe inward and placing it in a labeled sample container. The wipe sample will be analyzed by flame atomic absorption using EPA method SW846. The Contractor shall re-clean the work zone if :

(i) the surface concentrations exceed the pre-existing (baseline) levels collected prior to the commencement of work or

(ii) the surface concentrations exceed the following levels,  
whichever of (i) or (ii) listed above is lower:

40  $\mu\text{g}/\text{ft}^2$ .....for floors.

250  $\mu\text{g}/\text{ft}^2$ .....for interior windowsills and stools.

400  $\mu\text{g}/\text{ft}^2$ .....for window troughs.

400  $\mu\text{g}/\text{ft}^2$ .....for exterior concrete or other rough surfaces.

350 ppm .....for soil (or the pre-existing 'baseline' level, whichever is lower).

b. The cleaning and testing will cease only after all required paints are abated and all sample results are below these specified levels. Sample analysis times will be within 1 workday, unless otherwise indicated.

c. If the above levels are enumerated in paragraph 3 a above are exceeded, the final testing procedure shall then be repeated at Contractor's expense. This shall include, but not be limited to, the sampling and analysis costs for the samples during re-cleaning and the final clearance, HazMat Project Manager's costs and expenses, any and all contractual penalties, liquidated damages, etc., levied by the owner and/or other trades that may be impacted by the change in schedule.

4. Air Sampling Criteria (As Applicable): Aggressive air sampling will be conducted for lead simultaneous to the asbestos clearance air sampling. Air samples will be analyzed for total lead in accordance with Lead in Air by Flame AAS NIOSH method 7082. The clearance criterion for lead shall be an airborne concentration below OSHA's "Action Level" of 30 micrograms per cubic meter of lead ( $30 \mu\text{g}/\text{m}^3$ ), on an 8 hour Time Weighted Average (TWA), for all samples.

### 3.9 Lead Waste Handling Procedures

A. All disposable personal protective equipment, respirator cartridges, and HEPA vacuum filters shall be packaged and disposed of upon completion of the work shift and when the lead removal operation has been completed.

B. All removed lead-containing materials, lead-contaminated clothing and equipment, and lead-containing dust/debris shall be packaged and placed into waste containers approved for use by both the waste transporter and landfill.

C. Properly label each lead waste container in accordance with the requirements of the waste hauler and the landfill. At a minimum, the labels shall identify the type of waste and the date lead-contaminated wastes were first put into the container.

D. The Contractor shall make provisions for the safe storage of waste on site for waste characterization and eventual disposal. For health and safety reasons, waste storage areas must be treated as lead work control areas with restricted access.

### 3.10 Lead Waste Disposal

A. The Contractor shall perform at their expense, any and all waste characterization and analysis of lead-containing waste or lead-contaminated waste generated during this project. The waste characterization sampling performed on the waste will be in accordance with Title 22.

- B. Any and all waste including but not limited to waste generated from abatement projects, demolition debris and/or soil excavation, with total lead content greater than 350 parts per million and scheduled for disposal in California, must be disposed of at a Class I hazardous waste landfill, or at other landfills that have specific permits to accept these waste. Copies of all waste permits from the waste disposal facility shall be included as a part of the pre-job submittal.
- C. For all waste generated from the site one or more of the following characterization tests must be performed:

Total Threshold Limit Concentration (TTLC) <i>(California State Requirement)</i>	(a) If greater than or equal to 1000 mg/kg the waste must be disposed as a Class I Hazardous Waste, (b) If less than 1000 mg/kg but greater than or equal to 50 mg/kg then perform the W.E.T.(STLC) test, (c) If less than 50 mg/kg can be disposed of as construction debris
Waste Extraction Test Soluble Threshold Limit Concentration (WET-STLC) <i>(California State Requirement)</i>	(a) If greater than or equal to 5mg/l the waste must be disposed as a Class I Hazardous Waste after performing the TCLP Test (Federal) (b) If less than 5 mg/l can be disposed of as construction debris.
Toxicity Characteristic Leachate Procedure (TCLP) <i>(Federally Regulated)</i>	(a) If greater than or equal to 5mg/l the waste must be stabilized prior to being disposed as a Class I Hazardous Waste (b) If less than 5mg/l the waste stabilization is not required. However the material must be disposed as a Class I Hazardous Waste

**3.11 OSHA Personnel Air Monitoring**

- A. Air monitoring required by OSHA for lead exposure is work of the contractor. The contractor is responsible for providing daily OSHA compliance monitoring as per 29 CFR Part 1926.62 and 8 CCR Part 1532.1.
  1. At minimum, Contractor shall conduct representative (25% of crew) breathing zone personal air monitoring of its employees twice each shift and repeated daily.
  2. Monitoring shall be conducted by a qualified professional experienced and knowledgeable about the methods of air monitoring and in accordance with 29 CFR Part 1926.62 and 8 CCR Part 1532.1.
  3. Monitoring results and appropriate laboratory analysis work shall be submitted to Owner’s Representative within twenty-four (24) hours of the monitoring work.

**3.12 Alternate Procedures**

- A. The procedures described in this Section shall be utilized at all times.
- B. If specified procedures cannot be utilized, a request shall be made in writing to the Owner providing details of the problem encountered and proposed alternatives.
- C. Alternative procedures shall provide equivalent or greater protection than the procedures that they replace.
- D. Alternative procedure shall be approved in writing by the Owner and HazMat Project Manager prior to implementation.

## SECTION 02 84 00

### POLYCHLORINATED BIPHENYLS (PCB) AND FLUORESCENT TUBES REMOVAL

#### PART 1 GENERAL

##### 1.01 DESCRIPTION

The work of this section consists of furnishing all transportation, labor, materials, equipment and incidentals necessary to legally handle and dispose of offsite all Polychlorinated Biphenyl (PCB) containing materials (fluorescent light ballasts), fluorescent tubes containing mercury vapor, and other hazardous materials.

##### 1.02 SCOPE OF WORK

- A. The Contractor is responsible for the removal, handling, transport, and proper disposal of PCB-containing materials including fluorescent light ballasts. The Contractor shall inspect remaining fluorescent light fixtures, remove all ballasts which are not marked "Non-PCB containing" or "No PCBs", package, and dispose of in accordance with the requirements identified in this section.
- B. The Contractor is responsible for the removal, handling, transport, and disposal of fluorescent tubes containing mercury vapor. Contractor shall remove, package and dispose of all remaining fluorescent light tubes in accordance with the requirements of this section.

##### 1.03 RELATED WORK

- A. SECTION 02 82 13 – ASBESTOS ABATEMENT WORK
- B. SECTION 02 83 00 – LEAD-RELATED DEMOLITION WORK

##### 1.04 APPLICABLE DOCUMENTS AND REGULATIONS

- A. It is the responsibility of the Contractor to know the current regulations controlling work and to perform all related work in accordance with such regulations that provide for worker and public safety against asbestos exposure.
- B. The publications listed below form a part of this specification to the extent referenced. The current issue of each document shall govern. Where conflict among requirements or with these Specifications exists, the more stringent requirements shall apply.

##### CODE OF FEDERAL REGULATIONS (CFR)

40 CFR 761	Polychlorinated Biphenyl (PCBs) Manufacturing, Processing, Distribution in Commerce and Use Prohibitions
29 CFR 1910.134	Respiratory Protection
29 CFR 1910.145	Accident Prevention Signs and Tags
40 CFR 178	Shipping Container Specification



**AMERICAN NATIONAL STANDARD INSTITUTE (ANSI) PUBLICATION**

Z88.2-69 Practices for respiratory protection

**UNDERWRITERS LABORATORIES, INC.**

UL 586 1990 High-Efficiency Particulate Air Filter Units

**1.05 DEFINITIONS**

- A. “Polychlorinated Biphenyls (PCBs)” as used in this specification shall mean the same as PCB Article, PCB Article Container, PCB Container, PCB Equipment, PCB Item, PCB Transformer, PCB Contaminated Transformer, as defined in 40 CFR 716.3.
- B. “Leak or leaking” means any instance in which a PCB Article, PCB Container, or PCB Equipment has any PCBs on any portion of its external surface.
- C. “Spill” means intentional and unintentional spills, leaks, and other uncontrolled emissions resulting in any quantity of hazardous material being released to the environment.
- D. “Control Area” means a restricted area posted with the proper warning/caution signs in which only trained persons may enter.
- E. “High Efficiency Particulate Air (HEPA) Filters (for PCB dust)” means a filter capable of removing 99.97% of the particles down to 0.3 microns ( $\Phi$ ) in diameter and consistent with a UL 586 filter system.
- F. “Mercury Filter” means a special mercury filter cartridge carrying proper test and certification approval number for mercury vapor work.
- G. “Other Hazardous Materials and Potentially Hazardous Materials” means all hazardous materials or potentially hazardous materials not otherwise defined in this specification as Asbestos, Chlorofluorocarbons (CFCs), Polychlorinated Biphenyls (PCBs), Fluorescent Tubes, Mercury, or Lead Based Paint shall be considered as Other Hazardous Materials and Potentially Hazardous Materials.
- H. Hazmat Project Manager (HPM) means the on-site representative from HazMat Doc. The HPM is also one of the owner’s representatives.

## **1.06 QUALITY ASSURANCE**

- A. Training: Instruct employees on the dangers of mercury vapor, PCB, and other hazardous materials exposure, on respirator use, decontamination, and applicable OSHA and EPA regulations.
- B. Regulation Documents: Maintain at all times one copy each at the office and one copy each in view at the job site of the approved Contractor's Removal, Storage, and Disposal Work Plan, including addenda and revisions.
- C. Access by the Owner, Owners Representative or HPM: The Owner/Owner's Representative/HPM may enter control areas for brief periods of time provided they underwent proper training, donned disposable polyethylene gloves and disposable polyethylene foot covers, as a minimum. Additional protective equipment may be required if respiratory hazard is involved or if skin contact is involved. Contractor shall provide all required personnel protective equipment and training for the Owner/Owner's Representative/HPM as required for safe entry and visual inspection in contaminated areas.

## **1.07 SUBMITTALS**

- A. Submit, as applicable, the following to the Owner/Owner's Representative/HPM for approval within 10 days of receiving the Notice to Proceed. These submittals are in addition to those required in Section 02 82 13 or Section 02 83 00. These submittals shall be submitted in accordance with Section 02 84 16:
  - 1. Training Certification of Employees: Submit certificates signed and dated by an officer of the Contractor and by each employee stating that the employee has received required training.
  - 2. Removal, Storage, Packaging, Transportation, and Disposal Work Plan: Submit a Removal, Storage, Packaging, Transportation, and Disposal Work Plan. Submit a detailed job-specific plan of the work procedures to be used in the removal of: fluorescent light bulbs; PCB-containing ballasts, other oils; and mercury containing devices. Include in the plan: eating, drinking, smoking and restroom procedures; leak and spill clean-up; procedures for identifying other hazardous materials and potentially hazardous materials; interface of trades; sequencing of related work; training requirements; respiratory protection requirements; personal protective equipment to be utilized; temporary storage locations; packaging procedures; transportation procedures and disposal sites. Include personal air sampling (if required), sampling methodology, frequency, duration of sampling, and qualifications of air monitoring personnel in the air sampling portion of the plan.
- B. Upon completion of all removal activities, submit to the Owner/Owner's Representative/HPM, documentation that includes the following.
  - 1. The Contractor shall keep records of all documents generated in the course of the work. These include copies of all forms and reports of spills, accidents, personal exposure monitoring, hazardous materials removal logs, and hazardous waste manifests. Copies of all records shall be submitted to the Owner/Owner's Representative/HPM at the completion of the work.

## **1.08 EQUIPMENT**

- A. Personal Protective Equipment: Work clothes shall consist of Personnel Protection Equipment (PPE) as required by OSHA regulations, including, but not limited to the following:
  - 1. Disposable coveralls;
  - 2. Gloves;

3. Chemical safety goggles;
  4. Half mask cartridge respirator for mercury vapor, PCBs and/or other hazardous material - to be used for spills;
  5. Disposable foot covers (polyethylene).
- B. Leak/Spill Kit: Assemble a leak/spill kit to include at a minimum, the following items for maximum 200-gallon potential spills. For items where a larger spill potential exists, multiply quantities provided accordingly:
1. Gloves specifically rated for use in handling PCBs (six pairs);
  2. Disposable coverall specifically rated for use in handling PCBs (four each);
  3. Chemical safety goggles (two each);
  4. Disposable foot covers (polyethylene) (six pairs);
  5. PCB Caution Sign: "PCB-Spill --- Authorized Personnel Only" (two each);
  6. Banner guard or equivalent banner material (100 feet);
  7. Absorbent material (five bags);
  8. Rags (20 each);
  9. HEPA vacuum (one each);
  10. Poly lined DOT 17H drums (two each);
  11. Blue polyethylene waste bags (five each).

**Note: All materials and equipment used to clean up a PCB spill become PCB waste and must be disposed of accordingly.**

**PART 2 PRODUCTS**

Not Used

## PART 3 EXECUTION

### 3.01 REQUIREMENTS

- A. The Contractor shall furnish all labor, materials, and equipment necessary for the complete collection and removal of all PCBs, fluorescent light tubes, ballasts, mercury and other hazardous materials or potentially hazardous materials from the project site.
- B. All hazardous materials which are identified as in-scope requirements shall be properly packaged, delivered to, and disposed of at a properly licensed disposal facility. The PCB-containing articles shall be incinerated. The mercury-containing fluorescent tubes shall be recycled.
- C. The Contractor shall prepare hazardous waste manifest that will accompany the hazardous materials to the storage site. The Contractor shall ensure that a responsible person from the District signs the form. The Contractor is responsible to ensure that the form from point of origin to point of disposal is filled out completely and accurately for complete tracking of hazardous materials. A copy of each hazardous waste manifest shall be submitted to the following:

HazMat Doc  
3080 Olcott Street, Suite 135D  
Santa Clara, CA 95054  
Tel: 408-748-0055  
Fax: 408-748-0066

Re: (Project Name and Address)

- D. The Contractor shall verify that the storage site is capable of accepting the hazardous materials within regulatory compliance prior to delivery of the hazardous materials.
- E. Isolate a PCB control area by physical boundaries to prevent unauthorized entry of personnel.
- F. Personnel Protection: Workers shall wear and use PPE as required in Article 1.08 of this section upon entering a control area.
- G. Permissible Exposure Limits (PEL):
  - 1. The PEL for mercury is 0.05 mg/m<sup>3</sup> of air based on an 8-hour time weighted average (TWA).
  - 2. The PEL for PCBs is 0.5 mg/m<sup>3</sup> based on an 8-hour time weighted average basis.
  - 3. The Contractor shall perform Personal Sampling to ensure the PEL is not exceeded.
- H. Special Hazards
  - 1. Fluorescent light bulbs shall be handled with care during removal and packaging and any breakage shall be reported and the spill cleaned up immediately.
  - 2. Ballasts shall not be exposed to open flames or other high temperature sources since toxic decomposition by-products may be produced.
  - 3. Other hazardous materials or potentially hazardous materials shall be properly identified prior to handling or exposure.

I. Caution Label

1. Affix labels to all waste containers. Provide label with sufficient print size to be clearly legible, with bold print on a contrasting background, displaying the following:

CAUTION: CONTAINS <i>(name of hazardous material)</i>	
DATE: _____	SOURCE: _____
EPA Generator No. _____	

J. Caution Signage

1. Per 29 CFR 1910.145, provide signs at approaches to PCB control areas. Locate signs at such a distance that personnel may read the sign and take the necessary precautions before entering the area.

**3.02 WORK PROCEDURE**

A. Furnish all labor, materials, services, and equipment necessary for the complete removal of all PCB/Non-PCB Ballasts, fluorescent light bulbs, and other hazardous materials and potentially hazardous materials in accordance with federal, state, and local regulations.

1. Package and mark fluorescent light bulbs and ballasts as required by EPA and DOT regulations and dispose of offsite.
2. Provide packaging, available from the manufacturer, for the storage of fluorescent light bulbs. Provide 17C or 17H drums for packaging of PCB ballasts.
3. Fluorescent light bulbs, and ballasts labeled as “Non-PCB Containing” or “No PCBs”, shall be packaged in leak-proof packaging, and be transported under manifest/trip ticket and disposed of for either (a) recycling or (b) disposal in full compliance with local, state and federal regulations. A manifest/trip-ticket or equivalent endorsed by the waste disposal facility or the recycler shall be provided to the HPM within 2 working days of the waste being moved of the site.

B. Smoking: Smoking is not permitted within 50 feet of the control area. Provide and post “No Smoking” signs.

C. Work Operations: Ensure that work operations or processes are conducted in accordance with the applicable requirements of this section, including but not limited to:

1. Obtain advance approval of storage sites.
2. Report spills/leaks to the Owner/Owner’s Representative/HPM and maintain a record detailing the circumstances surrounding the leak/spill include the location, material leaked/spilled, estimated quantity, cleanup procedure utilized, and disposition of waste.
3. Maintain a spill/leak kit for immediate clean up of spill/leaks.
4. Maintain an access log of employees working in a control area and provide a copy to the District’s representative upon completion of the operation.

### **3.03 REMOVAL WORK**

- A. Establish a control area as specified in paragraph entitled “Control Area”. Only personnel briefed on the handling and safety precautions shall be allowed into the area.
- B. Work performed in confined spaces shall be performed in accordance with applicable Cal/OSHA requirements.
- C. Remove mercury containing bulbs and other devices intact and immediately package for disposal. Handle in a manner that will prevent skin contact.
- D. Remove all fluorescent light ballasts that are not marked “Non-PCB containing” or “No PCBs”. Place ballasts in DOT approved 17C or 17H drums. Handle PCBs such that no skin contact occurs.
- E. Remove all other equipment containing PCBs from site and transport to an approved decontamination facility for final disposal.

### **3.04 SPILL/LEAK REQUIREMENTS**

- A. Spills/Leaks: Report any spill/leak to the District’s Representative immediately.
- B. Spill/Leak Control Area: Establish a spill/leak control area and restrict access to properly trained personnel utilizing appropriate personal protective equipment.
- C. Employee Safety: The contractor shall be responsible for ensuring that his personnel are knowledgeable and protected from the health and safety hazards of working with PCBs. The Contractor is advised to follow the guidance promulgated by EPA’s Standard Operating Safety Guides (latest edition), the NIOSH, OSHA, USCG, EPA’s Occupational Safety and Health Guidance Manual for Hazardous Waste Site Activities (latest edition) based on 29 CFR 1910.120.
- D. Spill/Leak Cleanup Procedures
  1. Initiate cleanup of spill/leaks as soon as possible. Immediately transfer broken items into a DOT approved 17H, poly lined drum or other approved container. To clean up spills, personnel shall wear the PPE prescribed in paragraph entitle “Special Clothing.” Mop up any liquids with rags or other conventional absorbent. The spent absorbent shall be properly contained and disposed of as solid PCB waste. HEPA vacuum the spill area. HEPA vacuumed waste shall be drummed in a poly lined DOT 17H drum and labeled with a DOT approved caution label.
  2. The Contractor shall be responsible for the proper cleanup of all pre-existing or inadvertent spills or leaks. Any leaks shall be immediately stopped, contained, covered, and diked as necessary to facilitate clean-up operations and to prevent the hazardous materials from entering drains, storm sewers, or other water bodies. The District shall be immediately notified by a subsequent written report describing the details of the spill or leak, and what actions have been taken to clean-up the spill or leak. The hosing down of any spillage or leaks is prohibited. In the event of a Contractor caused fire involving hazardous materials, the Contractor shall be responsible for the cleanup of any contamination caused by the hazardous, toxic products of combustion.

### 3.05 STORAGE FOR DISPOSAL

- A. Storage Containers
  - 1. Intact fluorescent light bulbs shall be placed in the packaging that is available from the manufacturer.
  - 2. Store non-liquid PCB mixtures, articles, or equipment in DOT Specification 17C or 17H containers.
- B. The contractor shall properly label and mark all hazardous materials and ensure that the vehicle used to transport the hazardous materials is also placarded in accordance with EPA and DOT requirements.
- C. Waste Containers: Label waste containers in accordance with the requirements of this section.
- D. Temporary Onsite Storage: Obtain written approval for temporary onsite storage from the Owner/Owner's Representative/HPM. Temporary onsite storage areas must comply with the following: (1) Provide adequate roof and walls to prevent rainwater from reaching the stored material; (2) Provide containment curbs to prevent the spread of secondary contamination in the event of a container leak. Hazardous waste shall not be stored on site for longer than regulations allow, but in no case longer than 14 days or the end of the contractor's onsite activity – whichever is earlier.
- E. The contractor shall make every endeavor to recycle as much of the waste generated from this project as possible. To this end the contractor may contact the following facilities to assist them in putting together a recycling plan for this project

**AERC Recycling Facility**  
30677 Huntwood Avenue  
Hayward, CA 94544  
Tel: 510-429-1129  
Fax: 510-429-1498  
www.aercycling.com

Or

**Lighting Resources Inc.**  
805 East Francis St.  
Ontario, CA 91761  
800-572-9253  
www.lightingresourcesinc.com

### 3.06 CONTROL AREA HOUSEKEEPING

- A. Maintain surfaces of the control area free of accumulations of fluorescent light bulb debris, PCBs, and other hazardous materials. Restrict the spread of dust and debris; keep waste from being distributed over work area. Do not remove the control area and warning signs prior to the District's representative's approval. Re-clean areas showing residual dust or debris.

END OF SECTION



## APPENDIX –A

### SCOPE OF WORK

#### SHEET NOTES FOR THE ABATEMENT SCOPE OF WORK

The following notes will apply in their entirety, without exclusions or exemptions, to the entire Scope of Work for this Project unless otherwise instructed to in writing:

1. These Buildings are slated for renovation and/or reconfiguration. Coordinate work activities with HPM, Construction Manager and other trades as applicable. Prior to the commencement of abatement or removal activities, it is the Contractors responsibility to reconcile all the abatement/removal scope of work materials and locations listed herein with the intent of the Project Construction Manager and/or the Owners Representative.
2. Contractors shall bid all quantities listed herein. Any and all additions and/or deductions shall be based on the Abatement Unit Prices (Appendix – B) attached hereto.
3. The Contractor shall be responsible for independently verifying ALL quantities enumerated.
4. The Contractor shall be responsible for the abatement/removal of ALL LISTED MATERIALS - IN ALL LOCATIONS as indicated in these documents.
5. The Contractor shall be responsible for the quantification of all materials actually removed from ALL LOCATIONS.
6. Any and all items that are left in/on the Building(s) that may be affected by of this Scope of Work are to be protected in place unless otherwise directed (in writing) by the Owner or the Owners designee.
7. These Scopes of Work are created on the basis of the Architectural Drawings and/or the information received from the Owner/the Owners representative. It is restricted to those materials surfaces and quantities that are designated to be impacted during the modernization. This is not a complete inventory of all known or suspect hazardous materials in these areas, nor should it be construed to be a comprehensive hazardous materials report for these work areas.

#### Asbestos Abatement Scope of Work Notes:

- a) All items enumerated are to be removed in accordance with Section 02 82 00 of the attached Specifications and in full compliance with current Local, State and Federal regulations. In the event of a conflict between the regulations and the specifications the most stringent shall apply.
- b) Multiple Containment(s) could be required in the same locations in order to coordinate activities with other trades. The Asbestos Removal Contractor's Base Bid shall include two (2) additional mobilizations (in addition to the initial mobilization) and containment costs per Building for Asbestos related work.
- c) For the removal of Asbestos Containing Materials by Mechanical Means and use of Regulated Solvents –
  - (i) If ANY Asbestos Containing Materials are removed by Mechanical Means  
(1a) BAAQMD Notification and Friable Material Removal Preparations will be required, and  
(1b) The waste products must be disposed of as Hazardous Waste.
  - (ii) If Mastics/Adhesives are removed with Regulated Solvents  
The waste products must be disposed of in accordance with prevailing regulations and the MSDS for that Solvent.
- d) All Asbestos Containing Material Finishes are to be removed as directed in their entirety to the framing/substrate, including any insulation materials encountered. Framing/Substrate is to be cleaned of any residues, nails, etc, and remain intact.
- e) For the removal of Asbestos Containing Roofing Materials (ACRM) or roof related materials/sealants etc., all materials are to be removed in their entirety to the roof deck/wall. Roof deck/wall is to be cleaned of any residues, nails, etc, and remain intact. For penetrations/patches/edges, an additional 1' of roofing material around each roof penetration/patch/edge is to be removed (all layers to roof deck) to ensure the complete removal of the roofing sealant(s).

**Lead Abatement/ Removal Scope of Work Notes:**

- a) All items enumerated are to be removed in accordance with Section 02 83 00 of the attached Specifications and in full compliance with current Local, State and Federal regulations. In the event of a conflict between the regulations and the specifications, the most stringent shall apply.
- b) Multiple Containment(s) could be required in the same locations in order to coordinate activities with other trades. The Lead Removal Contractor's Base Bid shall include two (2) additional mobilizations (in addition to the initial mobilization) and containment costs per building for Lead related work.
- c) Special Removal and Disposal Instructions:

**(i) In Areas for Removal**

Remove all layers of Material/Component to framing/substrate, including any insulation materials and Dispose of as Lead Containing Waste; framing/substrate to be cleaned and remain intact.

**NOTE 1:** If Lead Coated Metal Components are to be "recycled" instead of being disposed of as Lead Containing Waste, the Contractor must – (I) appropriately stabilize component prior to transport, (i.e., remove all peeling-chipping paint from entire component and seal the leading edges of removed areas with an appropriate sealant); (II) provide the owner with documentation from the Metal Recycler, confirming acceptance of known Lead Coated materials; (III) transport these materials under proper manifest/trip ticket; and (IV) provide a copy of the trip ticket signed by the Recycler, proving appropriate disposal of the Scope of Work Item(s).

**NOTE 2:** If Lead Coated Components are to be salvaged and returned to "Owner", the coatings must be appropriately stabilized before released back to "Owner's" Representative.

**(ii) In areas for Modification/Attachment**

Remove all Layers of Paint and Dispose of as Lead Containing Waste. Finish (i.e. "feather") the leading edge of removed area and Stabilize ('Coat' Over) with an approved "Sealant" to enable Prep, Priming, and Repainting by Others. For anticipated welding, torching or other 'hot work' on metal, remove all layers of paint to bare metal at a minimum of 18 inches on each side (on all faces of the metal) of the anticipated work. For anticipated mechanical impact remove all layers to bare substrate at a minimum of 6 inches each side (on all faces of the component) of the anticipated work.

**(iii) In Areas for Repainting**

Manually Abrade/Scrape all accessible surfaces in their entirety, being careful to remove all 'peeling-chipping' paint. Manually Wash/Scrub all 'build-up' (Chalking residue, Grime, etc.) from all accessible surfaces. Dispose of all Waste Products and Debris as Lead Containing Waste. Finish (i.e. "feather") the leading edge of removed area and Stabilize ('Coat' Over) with an approved "Sealant" to enable Prep, Priming, and Repainting by Others.

**THE LEAD SCOPE(S) OF WORK INCLUDE(S) ONLY THE ITEMS WITH COATINGS/CONTENT THAT ARE AT OR ABOVE THE THRESHOLD REQUIRING LEAD ABATEMENT CERTIFIED PERSONNEL; PLEASE SEE THE ATTACHED SAMPLING REPORTS FOR ALL OTHER COATINGS/COMPONENTS THAT WERE BELOW THAT THRESHOLD.**

**Poly Chlorinated Biphenyl Remediation Notes:**

- a) All items enumerated are to be removed in accordance with Section 02 84 00 of the attached Specifications and in full compliance with current Local, State and Federal regulations. In the event of a conflict between the regulations and the specifications the most stringent shall apply.
- b) Light bulbs/tubes are to be removed and disposed of as Mercury containing waste.
- c) Light fixture ballasts are to be removed and disposed of as Poly-Chlorinated Bi-Phenyl (PCB) containing waste unless expressly labeled as "Non-PCB" or "No PCB's". If ballasts are labeled as "Non-PCB" or "No PCB's", they must be appropriately disposed of and/or recycled.

# ASBESTOS, MERCURY AND PCB SCOPE OF WORK

OCTOBER 19, 2018

## TOYON ELEMENTARY SCHOOL FLEXIBLE INSTRUCTION SPACE PROJECT BUILDING H – OLD LIBRARY AREAS

**Page 1 of 2**

All items enumerated below are to be removed and disposed of as ACM or ACRM unless otherwise noted.

<u>ITEM #</u>	<u>LOCATION / MATERIAL</u>	<u>APPROXIMATE QUANTITY*</u>
1.	<p>(Interior) H02 Circulation, H03 AV Storage, H04 Staff, H05 Staff Resource, and H09 West Work Area, Ceilings / <b>Non-ACM 1'x1' Glued-on Ceiling Tiles and Associated Mastic/Adhesive over ACM Joint Compound.</b></p> <p><b>NOTE 1: Contaminated Ceiling Tiles and Associated Mastic/Adhesive MUST be Removed as Asbestos Containing Waste.</b></p> <p><b>NOTE 2: Disposal of Contaminated Ceiling Tiles and Associated Mastic/Adhesive will depend on the Waste Profiling to be performed by the District's Project Monitor after Removal.</b></p> <p><b>NOTE 3: Any exposed/damaged areas of joint compound/mud exposed on ceiling after the removal of Ceiling Tiles and Associated Mastic/Adhesive must be sealed with a 'bridging encapsulant'.</b></p>	≈ 1,008 SF
2.	<p>(Interior) H01 Library, H02 Circulation, H03 AV Storage, H04 Staff, H05 Staff Resource, H07 North-East Work Area, H08 South-East Work Area, and H09 West Work Area, Ceilings in Path-of-Construction for removal of demising walls and fill-in or new penetrations / <b>Wallboard System Ceilings with ACM Joint Compound.</b></p> <p><b>NOTE 1: Any exposed/damaged areas of joint compound/mud exposed on ceiling after removal of wallboard system must be 'cleaned back' a minimum of 2 inches and must be sealed with a 'bridging encapsulant' to facilitate tying-in of new finishes by others.</b></p> <p><b>NOTE 2: This entry is only for the Wallboard System Ceilings and Ceiling/Wall Joints that may be disturbed by the Path-of-Construction. Actual Quantity of Material is ≈ 1,100 SF.</b></p>	≈ 200 SF
3.	<p>(Interior and Exterior) H01 Library, North side Perimeter Windows, in Path-of-Construction / <b>Windows with Black Sealant.</b> Remove Window Panes and Frames.</p>	<p>≈ 50 LF <b>(4 EA Windows)</b> (2 EA 3.5'x1.5' and 2 EA 3.5'x4' Windows).</p>

**NOTE(S):**

- A. REFER TO APPENDIX -A SCOPE OF WORK SHEET NOTES FOR ALL RELEVANT DIRECTIONS/INSTRUCTIONS FOR THIS SCOPE OF WORK.
- B. REFER TO ARCHITECTS DRAWING # A-3.0 AND A-4.1 FOR ROOM NUMBER REFERENCE, ETC.

Key: ACM = Asbestos Containing Material; ACRM = Asbestos Containing Roofing Material; SF = Square Feet; LF = Linear Feet; EA = Each

# ASBESTOS, MERCURY AND PCB SCOPE OF WORK

OCTOBER 19, 2018

## TOYON ELEMENTARY SCHOOL FLEXIBLE INSTRUCTION SPACE PROJECT BUILDING H – OLD LIBRARY AREAS

**Page 2 of 2**

All items enumerated below are to be removed and disposed of as ACM or ACRM unless otherwise noted.

<u>ITEM #</u>	<u>LOCATION / MATERIAL</u>	<u>APPROXIMATE QUANTITY*</u>
4.	(Interior) H01 Library, H02 Circulation, H03 AV Storage, H04 Staff, H05 Staff Resource, H07 North-East Work Area, H08 South-East Work Area, and H09 West Work Area, Demising Walls / <b>Windows with Black Sealant</b> . Remove Window Panes and Frames.	<b>≈ 369 LF (32 EA Windows)</b> (6 EA 3'x1.5', 12 EA 3.5'x4', 12 EA 3.5'x1.5', 1 EA 1'x1.5', 1 EA 1'x4').
5.	(Interior) H02 Circulation, in Concealed Locations (inside Wall/Ceiling Cavities and Attic/Plenum) / <b>Pipe Fitting and Pipe Insulation Materials</b>  <b>NOTE: The quantity listed for this item is an estimate only, provided for bidding purposes. Additions or deductions to this estimate will be done, on site, after work areas are opened up during the course of the Project. Additions or deductions will be pro-rated on the basis of the Unit Prices sheets (attached).</b>	<b>≈ 5 LF</b>
6.	(Interior and Exterior) H01 Library / <b>Suspect Insulated Doors</b> .  <b>NOTE 1: In areas of Replacement - Remove Intact. If Abatement Contractor determines by coring that Doors have Suspect ACM Core Insulation, Dispose of as Asbestos Containing Material. If Door(s) are determined to have no Core Insulation, dispose of properly as construction waste.</b>  <b>NOTE 2: In areas of Modification – Perform coring in area for Modification while in-situ. If Abatement Contractor determines by coring that Doors have Suspect ACM Core Insulation, Dispose of as Asbestos Containing Material. If Door(s) are determined to have no Core Insulation, leave in-situ.</b>	<b>2 EA Single-Doors for Removal and 1 EA Double-Door for Modification.</b>
7.	(Interior) H01 Library, H02 Circulation, H03 AV Storage, H04 Staff, H05 Staff Resource, H07 North-East Work Room, H08 South-East Work Room, and H09 West Work Area / <b>4' 4-Tube Fluorescent Light Fixture Assemblies (Including Fixtures, Light Bulbs/Tubes and Ballasts) and Recessed Light Fixture Assemblies.</b> (Typical 4 EA Tubes and 2 EA Ballasts)  <b>NOTE 1: Light bulbs/tubes are to be removed and disposed of as Mercury containing waste.</b> <b>NOTE 2: Light fixture ballasts are to be removed and disposed of as Poly-Chlorinated Bi-Phenyl (PCB) containing waste unless expressly labeled as "Non-PCB" or "No PCB's". If ballasts are labeled as "Non-PCB" or "No PCB's", they must be appropriately disposed of and/or recycled.</b>	<b>≈ 55 EA Fluorescent Light Fixture Assemblies and 9 EA Recessed Light Fixture Assemblies</b>

**NOTE(S):**

- A. REFER TO APPENDIX -A SCOPE OF WORK SHEET NOTES FOR ALL RELEVANT DIRECTIONS/INSTRUCTIONS FOR THIS SCOPE OF WORK.
- B. REFER TO ARCHITECTS DRAWING # A-3.0 AND A-4.1 FOR ROOM NUMBER REFERENCE, ETC.

Key: ACM = Asbestos Containing Material; ACRM = Asbestos Containing Roofing Material; SF = Square Feet; LF = Linear Feet; EA = Each

18-159

# LEAD SCOPE OF WORK

OCTOBER 19, 2018

## TOYON ELEMENTARY SCHOOL

FLEXIBLE INSTRUCTION SPACE PROJECT

BUILDING H – OLD LIBRARY AREAS

Page 1 of 1

All items enumerated below are to be removed and disposed of as Lead Waste unless otherwise noted.

<u>ITEM #</u>	<u>LOCATION / MATERIAL</u>	<u>APPROXIMATE QUANTITY*</u>
1.	(Exterior) Roof H02 Circulation / Pipe Sleeve. *** See <i>Special Removal and Disposal Instructions i-Component Removal</i> ***	1 EA

### NOTES

- A. REFER TO APPENDIX -A SCOPE OF WORK SHEET NOTES FOR ALL RELEVANT DIRECTIONS/INSTRUCTIONS FOR THIS SCOPE OF WORK.
- B. THIS SCOPE INCLUDES ONLY THE ITEMS WITH COATINGS/CONTENT THAT ARE AT OR ABOVE THE THRESHOLD REQUIRING LEAD ABATEMENT CERTIFIED PERSONNEL; PLEASE SEE THE ATTACHED SAMPLING REPORTS FOR ALL OTHER COATINGS/COMPONENTS THAT WERE BELOW THAT THRESHOLD.

Key: SF = Square Feet; LF = Linear Feet; EA = Each



# EMSL Analytical, Inc

464 McCormick Street, San Leandro, CA 94577

Phone/Fax: (510) 895-3675 / (510) 895-3680

<http://www.EMSL.com>

[sanleandrolab@emsl.com](mailto:sanleandrolab@emsl.com)

EMSL Order:	091717663
CustomerID:	HAZM63
CustomerPO:	
ProjectID:	

Attn: **Zen Doctor  
HazMat Doc  
3080 Olcott Street  
Suite 135D  
Santa Clara, CA 95054**

Phone: (408) 748-0055  
Fax: (408) 748-0066  
Received: 09/09/17 9:00 AM  
Collected: 9/5/2017

Project: **BERRYESSA UNION SCHOOL DISTRICT; TOYON ELEMENTARY SCHOOL 17-184**

## Test Report: Lead in Paint Chips by Flame AAS (SW 846 3050B/7000B)\*

Client SampleDescription	Collected	Analyzed	RDL	Lead Concentration
TP-37 091717663-0001	9/5/2017	9/15/2017	100 ppm	<100 ppm
Site: BLDG H NORTH SIDE EXTERIOR METAL ROOF FLASHING				
TP-38 091717663-0002	9/5/2017	9/15/2017	100 ppm	<100 ppm
Site: BLDG H NORTH SIDE EXTERIOR PLASTER WALL + OVERHANG				
TP-39 091717663-0003	9/5/2017	9/15/2017	100 ppm	<100 ppm
Site: BLDG H NORTH SIDE EXTERIOR WOOD WINDOW SYSTEM				
TP-40 091717663-0004	9/5/2017	9/15/2017	100 ppm	<100 ppm
Site: BLDG H NORTH SIDE EXTERIOR WOOD DOOR				
TP-41 091717663-0005	9/5/2017	9/15/2017	100 ppm	980 ppm
Site: BLDG H NORTH SIDE EXTERIOR METAL DOWNSPOUT				
TP-42 091717663-0006	9/5/2017	9/15/2017	100 ppm	1300 ppm
Site: BLDG G WEST SIDE EXTERIOR METAL + WOOD ROOF FLASHING + FASCIA				
TP-43 091717663-0007	9/5/2017	9/15/2017	100 ppm	<100 ppm
Site: BLDG G WEST SIDE EXTERIOR PLASTER WALL + OVERHANG				
TP-44 091717663-0008	9/5/2017	9/15/2017	100 ppm	140 ppm
Site: BLDG G WEST SIDE EXTERIOR WOOD+METAL WINDOW SYSTEM				
TP-45 091717663-0009	9/5/2017	9/15/2017	100 ppm	3700 ppm
Site: BLDG G WEST SIDE EXTERIOR METAL + WOOD DOOR SYSTEM				
TP-46 091717663-0010	9/5/2017	9/15/2017	100 ppm	2400 ppm
Site: BLDG G WEST SIDE EXTERIOR METAL DOWNSPOUT				

Julian Neagu, Lead Laboratory Manager  
or other approved signatory

\*Analysis following Lead in Paint by EMSL SOP/Determination of Environmental Lead by FLAA. Reporting limit is 0.010 % wt based on the minimum sample weight per our SOP. Unless noted, results in this report are not blank corrected. This report relates only to the samples reported above and may not be reproduced, except in full, without written approval by EMSL. EMSL bears no responsibility for sample collection activities. Samples received in good condition unless otherwise noted. "<" (less than) result signifies that the analyte was not detected at or above the reporting limit. Measurement of uncertainty is available upon request. The QC data associated with the sample results included in this report meet the recovery and precision requirements unless specifically indicated otherwise. Definitions of modifications are available upon request.

Samples analyzed by EMSL Analytical, Inc San Leandro, CA A2LA Accredited Environmental Testing Cert #2845.09

Initial report from 09/15/2017 15:08:39



# EMSL Analytical, Inc

464 McCormick Street, San Leandro, CA 94577

Phone/Fax: (510) 895-3675 / (510) 895-3680

<http://www.EMSL.com>

[sanleandrolab@emsl.com](mailto:sanleandrolab@emsl.com)

EMSL Order:	091717663
CustomerID:	HAZM63
CustomerPO:	
ProjectID:	

Attn: **Zen Doctor**  
**HazMat Doc**  
**3080 Olcott Street**  
**Suite 135D**  
**Santa Clara, CA 95054**

Phone: (408) 748-0055  
 Fax: (408) 748-0066  
 Received: 09/09/17 9:00 AM  
 Collected: 9/5/2017

Project: **BERRYESSA UNION SCHOOL DISTRICT; TOYON ELEMENTARY SCHOOL 17-184**

## Test Report: Lead in Paint Chips by Flame AAS (SW 846 3050B/7000B)\*

Client SampleDescription	Collected	Analyzed	RDL	Lead Concentration
TP-47 091717663-0011	9/5/2017	9/15/2017	100 ppm	290 ppm
Site: BLDG G SOUTH SIDE EXTERIOR PLASTER WALL				
TP-48 091717663-0012	9/5/2017	9/15/2017	100 ppm	4300 ppm
Site: BLDG K NORTH SIDE EXTERIOR WOOD WALL				
TP-49 091717663-0013	9/5/2017	9/15/2017	100 ppm	<100 ppm
Site: PORTABLE 24 EAST SIDE EXTERIOR METAL ROOF FLASHING				
TP-50 091717663-0014	9/5/2017	9/15/2017	100 ppm	<100 ppm
Site: PORTABLE 24 EAST SIDE EXTERIOR METAL + WOOD WALL SYSTEM				
TP-51 091717663-0015	9/5/2017	9/15/2017	100 ppm	<100 ppm
Site: PORTABLE 24 EAST SIDE EXTERIOR METAL + WOOD DOOR SYSTEM				
TP-52 091717663-0016	9/5/2017	9/15/2017	100 ppm	<100 ppm
Site: PORTABLE 24 EAST SIDE EXTERIOR METAL RAILING				
TP-53 091717663-0017	9/5/2017	9/15/2017	100 ppm	4000 ppm
Site: MAIN COVERED WALKWAY WEST SIDE EXTERIOR WOOD FASCIA				
TP-54 091717663-0018	9/5/2017	9/15/2017	100 ppm	1200 ppm
Site: MAIN COVERED WALKWAY WEST SIDE EXTERIOR METAL GUTTER COLUMN+DOWNSPOUT				
TP-55 091717663-0019	9/5/2017	9/15/2017	100 ppm	1400 ppm
Site: MAIN COVERED WALKWAY WEST SIDE EXTERIOR PLASTER SOFFIT				

Julian Neagu, Lead Laboratory Manager  
or other approved signatory

\*Analysis following Lead in Paint by EMSL SOP/Determination of Environmental Lead by FLAA. Reporting limit is 0.010 % wt based on the minimum sample weight per our SOP. Unless noted, results in this report are not blank corrected. This report relates only to the samples reported above and may not be reproduced, except in full, without written approval by EMSL. EMSL bears no responsibility for sample collection activities. Samples received in good condition unless otherwise noted. "<" (less than) result signifies that the analyte was not detected at or above the reporting limit. Measurement of uncertainty is available upon request. The QC data associated with the sample results included in this report meet the recovery and precision requirements unless specifically indicated otherwise. Definitions of modifications are available upon request.

Samples analyzed by EMSL Analytical, Inc San Leandro, CA A2LA Accredited Environmental Testing Cert #2845.09

Initial report from 09/15/2017 15:08:39



# EMSL Analytical, Inc

464 McCormick Street, San Leandro, CA 94577

Phone/Fax: (510) 895-3675 / (510) 895-3680

<http://www.EMSL.com>

[sanleandrolab@emsl.com](mailto:sanleandrolab@emsl.com)

EMSL Order:	091717663
CustomerID:	HAZM63
CustomerPO:	
ProjectID:	

Attn: **Zen Doctor  
 HazMat Doc  
 3080 Olcott Street  
 Suite 135D  
 Santa Clara, CA 95054**

Phone: (408) 748-0055  
 Fax: (408) 748-0066  
 Received: 09/09/17 9:00 AM  
 Collected: 9/5/2017

Project: **BERRYESSA UNION SCHOOL DISTRICT; TOYON ELEMENTARY SCHOOL 17-184**

## Test Report: Lead in Paint Chips by Flame AAS (SW 846 3050B/7000B)\*

<i>Client SampleDescription</i>	<i>Collected</i>	<i>Analyzed</i>	<i>RDL</i>	<i>Lead Concentration</i>
TP-56 091717663-0020	9/5/2017	9/15/2017	100 ppm	<100 ppm
Site: BLDG L NORTH SIDE EXTERIOR METAL + WOOD ROOF FLASHING				
TP-57 091717663-0021	9/5/2017	9/9/2017	100 ppm	<100 ppm
Site: BLDG L EAST SIDE EXTERIOR WOOD WALL + OVERHANG				
TP-58 091717663-0022	9/5/2017	9/9/2017	100 ppm	<100 ppm
Site: BLDG L SOUTH SIDE EXTERIOR METAL + WOOD DOOR + WINDOW SYSTEM				
TP-59 091717663-0023	9/5/2017	9/9/2017	100 ppm	<100 ppm
Site: BLDG E CLASSROOM 16-E16 1'1 CEILING TILE				
TP-60 091717663-0024	9/5/2017	9/9/2017	100 ppm	<100 ppm
Site: BLDG E BOYS RESTROOM E18 NORTH WALL GYPSUM BOARD				
TP-61 091717663-0025	9/5/2017	9/9/2017	100 ppm	<100 ppm
Site: BLDG E CLASSROOM 14-E14 EAST WALL TILE FIBERBOARD				
TP-62 091717663-0026	9/5/2017	9/9/2017	100 ppm	1500 ppm
Site: BLDG F CLASSROOM 20-F20 NORTH SIDE INTERIOR WOOD WINDOW SILL				

Julian Neagu, Lead Laboratory Manager  
or other approved signatory

\*Analysis following Lead in Paint by EMSL SOP/Determination of Environmental Lead by FLAA. Reporting limit is 0.010 % wt based on the minimum sample weight per our SOP. Unless noted, results in this report are not blank corrected. This report relates only to the samples reported above and may not be reproduced, except in full, without written approval by EMSL. EMSL bears no responsibility for sample collection activities. Samples received in good condition unless otherwise noted. "<" (less than) result signifies that the analyte was not detected at or above the reporting limit. Measurement of uncertainty is available upon request. The QC data associated with the sample results included in this report meet the recovery and precision requirements unless specifically indicated otherwise. Definitions of modifications are available upon request.

Samples analyzed by EMSL Analytical, Inc San Leandro, CA A2LA Accredited Environmental Testing Cert #2845.09

Initial report from 09/15/2017 15:08:39





091717663

CHAIN-OF-CUSTODY

JOB # 17-184

CLIENT NAME: BERRY ESSA UNION SCHOOL DISTRICT  
 PROJECT LOCATION: TOYON ELEMENTARY SCHOOL  
 SAMPLED BY: JBA DATE: 09-05-17

TURNAROUND TIME  
 STANDARD  
 OTHER 5 DAY

Sample #	Location/Type	Time On Time Off	FLOW RATES			Total Time	PCM	PLM	TBM	LEAD (Air, Paint, Soil, Water, Wipe)
			Start	Stop	Average					
TP-37	BLDG H, NORTH SIDE, EXTERIOR METAL ROOF FLASHING, BLUE								✓	
TP-38	" " EXTERIOR PLASTER WALL + OVERHANG, WHITE								✓	
TP-39	" " EXTERIOR WOOD WINDOW SYSTEM, WHITE								✓	
TP-40	" " EXTERIOR WOOD DOOR, BLUE								✓	
TP-41	" " EXTERIOR METAL DOWNSPOUT, WHITE								✓	
TP-42	BLDG G, WEST SIDE, EXTERIOR METAL + WOOD <sup>ROOF</sup> FLASHING + FASCIA, BLUE								✓	
TP-43	" " EXTERIOR PLASTER WALL + OVERHANG, WHITE								✓	
TP-44	" " EXTERIOR WOOD <sup>METAL</sup> WINDOW SYSTEM, WHITE								✓	
TP-45	" " EXTERIOR METAL + WOOD DOOR SYSTEM, BLUE								✓	
TP-46	" " EXTERIOR METAL DOWNSPOUT, WHITE								✓	
TP-47	" " SOUTH SIDE EXTERIOR PLASTER WALL, WHITE								✓	
TP-48	BLDG K, NORTH SIDE EXTERIOR WOOD WALL, WHITE								✓	

Relinquished By: CE FOR JBA Date & Time: 09-05-17 Received By: KLD Date & Time: 9/9/17 8:45a FX  
 Relinquished By: \_\_\_\_\_ Date & Time: \_\_\_\_\_ Received By: \_\_\_\_\_ Date & Time: \_\_\_\_\_



# CHAIN-OF-CUSTODY

JOB # 17-184

CLIENT NAME: BERRYESSA UNION SCHOOL DISTRICT  
 PROJECT LOCATION: TOYON ELEMENTARY SCHOOL  
 SAMPLED BY: ERM DATE: 09-05-17

TURNAROUND TIME  
 STANDARD  
 OTHER 5 DAY

Sample #	Location/Type	Time On Time Off	FLOW RATES			Total Time	PCM	PLM	TBM	LEAD (Air, Paint, Soil, Water, Wipe)
			Start	Stop	Average					
TP-49	PORTABLE-24, EAST SIDE, EXTERIOR METAL ROOF FLASHING, BLUE									✓
TP-50	" " EXTERIOR METAL + WOOD WALL SYSTEM, WHITE									✓
TP-51	" " EXTERIOR METAL + WOOD DOOR SYSTEM, BLUE									✓
TP-52	" " EXTERIOR METAL RAILING, BLUE									✓
TP-53	MAIN COVERED WALKWAY, WEST SIDE, EXTERIOR WOOD FASCIA, BLUE									✓
TP-54	" " EXTERIOR METAL GUTTER, COLUMN + DOWNSPOUT, BLUE									✓
TP-55	" " EXTERIOR PLASTER SOFFIT, WHITE									✓
TP-56	BLDG L, NORTH SIDE, EXTERIOR METAL + WOOD ROOF FLASHING, GUTTER, DOWNPOUT, FASCIA, BLUE									✓
TP-57	" " EAST SIDE, EXTERIOR WOOD WALL, FLASHING, WHITE									✓
TP-58	" " SOUTH SIDE, EXTERIOR METAL + WOOD DOOR + WINDOW SYSTEM, BLUE									✓
TP-59	BLDG E, CLASSROOM 16-E16, 1X1 CEILING TILE FIBER BOARD, WHITE									✓
TP-60	" " BOYS RESTROOM E18, NORTH WALL GYPSUM BOARD, WHITE									✓

Relinquished By: ERM Date & Time: 09-05-17 Received By: \_\_\_\_\_ Date & Time: \_\_\_\_\_  
 Relinquished By: \_\_\_\_\_ Date & Time: \_\_\_\_\_ Received By: \_\_\_\_\_ Date & Time: \_\_\_\_\_



# CHAIN-OF-CUSTODY

JOB # 17-184

CLIENT NAME:	<u>BERRYESSA UNION SCHOOL DISTRICT</u>	TURNAROUND TIME STANDARD OTHER <u>5 DAY</u>
PROJECT LOCATION:	<u>TOYON ELEMENTARY SCHOOL</u>	
SAMPLED BY:	<u>JSD</u> DATE: <u>09-07-17</u>	

Sample #	Location/Type	Time On Time Off	FLOW RATES			Total Time	PCM	PLM	TEM	<del>LEAD</del> (Air, <del>Paint</del> Soil, Water, Wipe)
			Start	Stop	Average					
TP-61	BLDG E, CLASSROOM 14-E14		EAST WALL, WALL TIVE FIBER BOARD, WHITE.							✓
TP-62	BLDG F, CLASSROOM 20-F20		NORTH SIDE, INTERIOR WOOD WINDOW SILL, BLUE.							✓

Relinquished By: <u>CE FOR JSD</u>	Date & Time: <u>09-07-17</u>	Received By: _____	Date & Time: _____
Relinquished By: _____	Date & Time: _____	Received By: _____	Date & Time: _____

**BUESD**  
**Toyon ES**  
 2017 Site Survey - Bldg H Excerpt

Reading No	Results	LOCATION	BUILDING	ROOM	SIDE	COMPONENT	SUBSTRATE	COLOR	CONDITION	Pb mg/cm <sup>2</sup>
1				SHUTTER	CALIBRATE					1.46
2	Positive			INSTRUMENT	CALIBRATE					1.10
3	Positive			INSTRUMENT	CALIBRATE					1.10
4	Positive			INSTRUMENT	CALIBRATE					1.10
161	Negative	INTERIOR	BLDG. H	LIBRARY H01	NORTH	2' X 2' CEILING TILE	FIBROUS PANEL	WHITE	FAIR	0.00
162	Negative	INTERIOR	BLDG. H	LIBRARY H01	NORTH	2' X 2' CEILING TILE GRID	METAL	OFF-WHITE	FAIR	0.00
163	Negative	INTERIOR	BLDG. H	LIBRARY H01	NORTH	UPPER WALL	DRYWALL	WHITE	FAIR	0.00
164	Negative	INTERIOR	BLDG. H	LIBRARY H01	NORTH	UPPER WALL TRIM	WOOD	WHITE	FAIR	0.01
165	Negative	INTERIOR	BLDG. H	LIBRARY H01	NORTH	1' x 1' CEILING TILE	FIBROUS PANEL	WHITE	FAIR	0.00
166	Negative	INTERIOR	BLDG. H	LIBRARY H01	NORTH	CEILING VENT	METAL	WHITE	FAIR	0.01
167	Negative	INTERIOR	BLDG. H	LIBRARY H01	NORTH	DOOR	WOOD	BLUE	CHIPPING	0.00
168	Negative	INTERIOR	BLDG. H	LIBRARY H01	NORTH	DOORFRAME	WOOD	WHITE	CHIPPING	0.00
169	Negative	INTERIOR	BLDG. H	LIBRARY H01	NORTH	DOORFRAME TRIM	WOOD	WHITE	CHIPPING	0.00
170	Negative	INTERIOR	BLDG. H	LIBRARY H01	NORTH	WINDOW	WOOD	WHITE	FAIR	0.02
171	Negative	INTERIOR	BLDG. H	LIBRARY H01	NORTH	WINDOW SILL	WOOD	WHITE	FAIR	0.00
172	Negative	INTERIOR	BLDG. H	LIBRARY H01	NORTH	WINDOW	WOOD PANEL	WHITE	FAIR	0.00
173	Negative	INTERIOR	BLDG. H	LIBRARY H01	NORTH	WALL	DRYWALL	WHITE	FAIR	0.00
174	Negative	INTERIOR	BLDG. H	LIBRARY H01	EAST	WALL	VINYL	WHITE	FAIR	0.00
175	Negative	INTERIOR	BLDG. H	LIBRARY H01	EAST	WINDOW	WOOD	WHITE	FAIR	0.00
176	Negative	INTERIOR	BLDG. H	LIBRARY H01	EAST	WINDOW SILL	WOOD	WHITE	FAIR	0.00
177	Negative	INTERIOR	BLDG. H	LIBRARY H01	EAST	WINDOW TRIM	WOOD	WHITE	FAIR	0.00
178	Negative	INTERIOR	BLDG. H	LIBRARY H01	EAST	DOOR	WOOD	WHITE	FAIR	0.00
179	Negative	INTERIOR	BLDG. H	LIBRARY H01	EAST	DOORFRAME	WOOD	WHITE	FAIR	0.00
180	Negative	INTERIOR	BLDG. H	LIBRARY H01	EAST	DOORFRAME TRIM	WOOD	WHITE	FAIR	0.00
181	Negative	INTERIOR	BLDG. H	LIBRARY H01	SOUTH	WALL	DRYWALL	WHITE	FAIR	0.01
182	Negative	INTERIOR	BLDG. H	LIBRARY H01	SOUTH	DOOR	WOOD	WHITE	FAIR	0.00
183	Negative	INTERIOR	BLDG. H	LIBRARY H01	SOUTH	DOORFRAME TRIM	WOOD	WHITE	FAIR	0.00
184	Negative	INTERIOR	BLDG. H	LIBRARY H01	SOUTH	WINDOW	WOOD	WHITE	FAIR	0.00
185	Negative	INTERIOR	BLDG. H	LIBRARY H01	SOUTH	WINDOW SILL	WOOD	WHITE	FAIR	0.00
186	Negative	INTERIOR	BLDG. H	LIBRARY H01	SOUTH	WINDOW	WOOD PANEL	WHITE	FAIR	0.00
187	Negative	INTERIOR	BLDG. H	LIBRARY H01	WEST	WALL	DRYWALL	WHITE	FAIR	0.00
188	Negative	INTERIOR	BLDG. H	LIBRARY H01	WEST	FIRE EXTINGUISHER BOX	METAL	WHITE	FAIR	0.03
189	Negative	INTERIOR	BLDG. H	LIBRARY H01	WEST	DOOR	WOOD	WHITE	FAIR	0.00
190	Negative	INTERIOR	BLDG. H	LIBRARY H01	WEST	DOORFRAME	WOOD	WHITE	FAIR	0.00
191	Negative	INTERIOR	BLDG. H	LIBRARY H01	WEST	DOORFRAME TRIM	WOOD	WHITE	FAIR	0.00
192	Negative	INTERIOR	BLDG. H	LIBRARY H01	WEST	WINDOW	WOOD	WHITE	FAIR	0.00
193	Negative	INTERIOR	BLDG. H	LIBRARY H01	WEST	WINDOW SILL	WOOD	WHITE	FAIR	0.00
194	Negative	INTERIOR	BLDG. H	LIBRARY H01	WEST	WINDOW	WOOD PANEL	WHITE	FAIR	0.00
195	Positive			INSTRUMENT	CALIBRATE					1.10
196	Positive			INSTRUMENT	CALIBRATE					1.10
197	Positive			INSTRUMENT	CALIBRATE					1.20

Tech: \_\_\_\_\_

CDHS I/A 17489

Pb = Lead

mg/cm<sup>2</sup> = milligrams / centimeter squared



# EMSL Analytical, Inc.

464 McCormick Street San Leandro, CA 94577

Tel/Fax: (510) 895-3675 / (510) 895-3680

<http://www.EMSL.com> / [sanleandrolab@emsl.com](mailto:sanleandrolab@emsl.com)

EMSL Order: 091822638

Customer ID: HAZM63

Customer PO: 18-159

Project ID:

Attention: Maheen B. Doctor

HazMat Doc

3080 Olcott Street

Suite 135D

Santa Clara, CA 95054

Project: 18-159 - BUESD - TOYON ES FIS MOD - BLDG H

Phone: (408) 748-0055

Fax:

Received Date: 10/16/2018 9:00 AM

Analysis Date: 10/17/2018

Collected Date: 10/15/2018

## Test Report: Asbestos Analysis of Bulk Materials via EPA 600/R-93/116 Method using Polarized Light Microscopy

Sample	Description	Appearance	Non-Asbestos		Asbestos
			% Fibrous	% Non-Fibrous	% Type
159-01 <small>091822638-0001</small>	ROOF H01 LIBRARY/HVAC DUCT & BERM SEALANT	Gray Non-Fibrous Homogeneous		40% Ca Carbonate 30% Matrix 30% Non-fibrous (Other)	None Detected
159-02 <small>091822638-0002</small>	ROOF H02 CIRCULATION/ROO F FIELD 1ST LAYER	White/Black Fibrous Homogeneous	10% Glass	5% Quartz 60% Matrix 25% Non-fibrous (Other)	None Detected
159-03 <small>091822638-0003</small>	ROOF H02 CIRCULATION/ROO F FIELD 2ND LAYER	Black Non-Fibrous Homogeneous		60% Matrix 40% Non-fibrous (Other)	None Detected
159-04 <small>091822638-0004</small>	ROOF H02 CIRCULATION/ROO F PENETRATION PIPE SEALANT	Black Non-Fibrous Homogeneous		60% Matrix 40% Non-fibrous (Other)	None Detected
159-05 <small>091822638-0005</small>	H01 LIBRARY EXT NORTH WINDOWS/BLACK SEALANT	Brown/Black Non-Fibrous Homogeneous	5% Cellulose	50% Matrix 42% Non-fibrous (Other)	3% Chrysotile
159-06 <small>091822638-0006</small>	H02 CIRCULATION EAST WINDOWS/BLACK SEALANT	Brown/Black Non-Fibrous Homogeneous		60% Matrix 37% Non-fibrous (Other)	3% Chrysotile
159-07 <small>091822638-0007</small>	H02 CIRCULATION EAST WALL NORTH END/WBS JOINT MUD	Tan Non-Fibrous Homogeneous		70% Ca Carbonate 30% Non-fibrous (Other)	None Detected
159-08 <small>091822638-0008</small>	H02 CIRCULATION EAST WALL NORTH END/WBS GYP BOARD	White Non-Fibrous Homogeneous	2% Cellulose	60% Gypsum 38% Non-fibrous (Other)	None Detected
159-09 <small>091822638-0009</small>	H02 CIRCULATION NORTH SIDE COUNTER/SINK INSULATION	Beige Non-Fibrous Homogeneous	5% Cellulose	50% Ca Carbonate 45% Non-fibrous (Other)	None Detected
159-10-Vinyl <small>091822638-0010</small>	H09 WEST WORK AREA NORTH WALL VCW/VINYL & ADHESIVE	White Fibrous Homogeneous	20% Cellulose	30% Matrix 50% Non-fibrous (Other)	None Detected
159-10-Adhesive <small>091822638-0010A</small>	H09 WEST WORK AREA NORTH WALL VCW/VINYL & ADHESIVE	Tan Non-Fibrous Homogeneous		50% Matrix 50% Non-fibrous (Other)	None Detected
159-11 <small>091822638-0011</small>	H09 WEST WORK AREA NORTH WALL VCW/WBS GYP MUD	Tan/White Non-Fibrous Homogeneous		70% Ca Carbonate 30% Non-fibrous (Other)	None Detected
159-12 <small>091822638-0012</small>	H09 WEST WORK AREA CEILING WEST SIDE/EDGE MUD	Tan/White Non-Fibrous Homogeneous		70% Ca Carbonate 30% Non-fibrous (Other)	None Detected

Initial report from: 10/17/2018 16:26:40



# EMSL Analytical, Inc.

464 McCormick Street San Leandro, CA 94577

Tel/Fax: (510) 895-3675 / (510) 895-3680

<http://www.EMSL.com> / [sanleandrolab@emsl.com](mailto:sanleandrolab@emsl.com)

**EMSL Order:** 091822638  
**Customer ID:** HAZM63  
**Customer PO:** 18-159  
**Project ID:**

## Test Report: Asbestos Analysis of Bulk Materials via EPA 600/R-93/116 Method using Polarized Light Microscopy

Sample	Description	Appearance	Non-Asbestos		Asbestos
			% Fibrous	% Non-Fibrous	% Type
159-13 <small>091822638-0013</small>	H09 WEST WORK AREA CEILING WEST SIDE/WBS JOINT COMPOUNDTAPE	White Non-Fibrous Homogeneous		60% Ca Carbonate 40% Non-fibrous (Other)	<1% Chrysotile
159-14 <small>091822638-0014</small>	H09 WEST WORK AREA CEILING WEST SIDE/WBS GYP BOARD	White Non-Fibrous Homogeneous	2% Cellulose	70% Gypsum 28% Non-fibrous (Other)	None Detected
159-15 <small>091822638-0015</small>	H09 WEST WORK AREA CEILING WEST SIDE/1'X1' CEILING TILE	White Fibrous Homogeneous	65% Cellulose 10% Min. Wool	25% Non-fibrous (Other)	None Detected
159-16 <small>091822638-0016</small>	H09 WEST WORK AREA CEILING WEST SIDE/1'X1' CEILING TILE ADHESIVE	Yellow Non-Fibrous Homogeneous		60% Matrix 40% Non-fibrous (Other)	None Detected
159-17 <small>091822638-0017</small>	H09 WEST WORK AREA CEILING WEST SIDE/REGISTER SEALANT	White Non-Fibrous Homogeneous		40% Ca Carbonate 30% Matrix 30% Non-fibrous (Other)	None Detected
159-18-Vinyl <small>091822638-0018</small>	H07 NORTH EAST WORK ROOM SOUTH WALL VCW/VINYL AND ADHESIVE	White Fibrous Homogeneous	15% Cellulose	30% Matrix 55% Non-fibrous (Other)	None Detected
159-18-Adhesive <small>091822638-0018A</small>	H07 NORTH EAST WORK ROOM SOUTH WALL VCW/VINYL AND ADHESIVE	White Non-Fibrous Homogeneous		50% Matrix 50% Non-fibrous (Other)	None Detected
159-19 <small>091822638-0019</small>	H07 NORTH EAST WORK ROOM SOUTH WALL VCW/WBS MUD	White Non-Fibrous Homogeneous		80% Ca Carbonate 20% Non-fibrous (Other)	None Detected
159-20 <small>091822638-0020</small>	H07 NORTH EAST WORK ROOM SOUTH WALL VCW/WBS GYP BOARD	White Non-Fibrous Homogeneous	2% Cellulose	70% Gypsum 28% Non-fibrous (Other)	None Detected
159-21 <small>091822638-0021</small>	H08 SOUTHEAST WORK ROOM NORTH CEILING/MAIN 2'X4' SCT	White Fibrous Homogeneous	75% Cellulose 10% Min. Wool	15% Non-fibrous (Other)	None Detected
159-22 <small>091822638-0022</small>	H08 SOUTHEAST WORK ROOM NORTH CEILING/REPLACEMENT 2'X4' SCT	White Fibrous Homogeneous	70% Cellulose 15% Min. Wool	15% Non-fibrous (Other)	None Detected

Initial report from: 10/17/2018 16:26:40



# EMSL Analytical, Inc.

464 McCormick Street San Leandro, CA 94577

Tel/Fax: (510) 895-3675 / (510) 895-3680

<http://www.EMSL.com> / [sanleandrolab@emsl.com](mailto:sanleandrolab@emsl.com)

**EMSL Order:** 091822638

**Customer ID:** HAZM63

**Customer PO:** 18-159

**Project ID:**

Analyst(s)

Beheshta Ahadi (24)

Matthew Batongbacal  
or Other Approved Signatory

EMSL maintains liability limited to cost of analysis. The above analyses were performed in general compliance with Appendix E to Subpart E of 40 CFR (previously EPA 600/M4-82-020 "Interim Method"), but augmented with procedures outlined in the 1993 ("final") version of the method. This report relates only to the samples reported above, and may not be reproduced, except in full, without written approval by EMSL. EMSL bears no responsibility for sample collection activities or analytical method limitations. Interpretation and use of test results are the responsibility of the client. All samples received in acceptable condition unless otherwise noted. This report must not be used by the client to claim product certification, approval, or endorsement by NVLAP, NIST or any agency of the federal government. EMSL recommends gravimetric reduction for all non-friable organically bound materials prior to analysis. Estimation of uncertainty is available on request.

Samples analyzed by EMSL Analytical, Inc San Leandro, CA NVLAP Lab Code 101048-3, WA C884

Initial report from: 10/17/2018 16:26:40



CHAIN-OF-CUSTODY

#091822638 JOB # 18-159

CLIENT NAME: BUESY TURNAROUND TIME  
 PROJECT LOCATION: COYON ES FIS MOD - BLDG H STANDARD  
 SAMPLED BY: AR DATE: 10/15/18 OTHER 24

Sample #	Location/Type	Time On Time Off	FLOW RATES			Total Time	PCM	PLM	TEM	LEAD (Air, Paint, Soil, Water, Wipe)
			Start	Stop	Average					
159-01	ROOF HO1 LIBRARY / HVAC DUCT & BERM SEALANT							X		
159-02	ROOF HO2 CIRCULATION / ROOF FIELD 1ST LAYER							X		
159-03	ROOF HO2 CIRCULATION / ROOF FIELD 2ND LAYER							X		
159-04	ROOF HO2 CIRCULATION / ROOF PENETRATION PIPE SEALANT							X		
159-05	HO1 LIBRARY EXT NORTH WINDOWS / BLACK SEALANT							X		
159-06	HO2 CIRCULATION EAST WINDOWS / BLACK SEALANT							X		
159-07	HO2 CIRCULATION EAST WALL NORTH END / WBS JOINT MUD							X		
159-08	HO2 CIRCULATION EAST WALL NORTH END / WBS GYP BOARD							V		
159-09	HO2 CIRCULATION NORTH SIDE COUNTER / SINK INSULATION							X		
159-10	HO9 WEST WORK AREA NORTH WALL VCW / VINYL & ADHESIVE							X		
159-11	HO9 WEST WORK AREA NORTH WALL VCW / WBS GYP MUD							X		
159-12	HO9 WEST WORK AREA CEILING WEST SIDE / EDGE MUD							X		

Relinquished By: AR Date & Time: 10/15/18 Received By: TR Date & Time: 10/16/18  
 Relinquished By: \_\_\_\_\_ Date & Time: \_\_\_\_\_ Received By: \_\_\_\_\_ Date & Time: 9:00AM  
 EFX (2)





# CHAIN-OF-CUSTODY

#091822638

JOB # 18-159

CLIENT NAME:	<u>BUESD</u>	TURNAROUND TIME
PROJECT LOCATION:	<u>10400 ES FIS MOUNT - BLDG H</u>	STANDARD
SAMPLED BY:	<u>XR</u> DATE: <u>10/15/18</u>	OTHER <u>24</u>

Sample #	Location/Type	Time On Time Off	FLOW RATES			Total Time	PCM	PLM	TEM	LEAD (Air, Paint, Soil, Water, Wipe)
			Start	Stop	Average					
159-13	H09 WEST WORK AREA CEILING		WEST SIDE / WBS JOINT COMPOUND TAPE				X			
159-14	H09 WEST WORK AREA CEILING		WEST SIDE / WBS GYP BOARD				X			
159-15	H09 WEST WORK AREA CEILING		WEST SIDE / 1'x1' CEILING TILE				X			
159-16	H09 WEST WORK AREA CEILING		WEST SIDE / 1'x1' CEILING TILE ADHESIVE				X			
159-17	H09 WEST WORK AREA CEILING		WEST SIDE / REG. STEEL SEALANT				X			
159-18	H07 NORTH EAST WORK ROOM SOUTH WALL		VCW / VINYL FLOOR ADHESIVE				X			
159-19	H07 NORTH EAST WORK ROOM SOUTH WALL		VCW / WBS INCL				X			
159-20	H07 NORTH EAST WORK ROOM SOUTH WALL		VCW / WBS GYP BOARD				X			
159-21	H08 SOUTHEAST WORK ROOM NORTH CEILING		MAIN 2'x4' SCT				X			
159-22	H08 SOUTHEAST WORK ROOM NORTH CEILING		REPLACEMENT 2'x4' SCT							
<del>159-23</del>										
<del>159-24</del>										

Relinquished By: <u>XR</u>	Date & Time: <u>10/15/18</u>	Received By: <u>TR</u>	Date & Time: <u>10/16/18</u>
Relinquished By: _____	Date & Time: _____	Received By: _____	Date & Time: <u>9:00 AM</u> <u>EFX (2)</u>



# EMSL Analytical, Inc.

464 McCormick Street San Leandro, CA 94577

Tel/Fax: (510) 895-3675 / (510) 895-3680

<http://www.EMSL.com> / [sanleandrolab@emsl.com](mailto:sanleandrolab@emsl.com)

EMSL Order: 091717700

Customer ID: HAZM63

Customer PO: 17-184

Project ID:

Attention: Maheen B. Doctor

HazMat Doc

3080 Olcott Street

Suite 135D

Santa Clara, CA 95054

Phone: (408) 748-0055

Fax: (408) 748-0066

Received Date: 09/09/2017 9:00 AM

Analysis Date: 09/15/2017

Collected Date: 09/06/2017

Project: 17-184 - Berryessa Union School District - Toyon Elementary School

## Test Report: Asbestos Analysis of Bulk Materials via EPA 600/R-93/116 Method using Polarized Light Microscopy

Sample	Description	Appearance	Non-Asbestos		Asbestos
			% Fibrous	% Non-Fibrous	% Type
TA-026 <small>091717700-0001</small>	Building G, Kitchen Only Tan and Dark Brown Mastic for 6" Blue Baseboard	Brown/Tan Non-Fibrous Homogeneous		80% Matrix 20% Non-fibrous (Other)	None Detected
TA-027 <small>091717700-0002</small>	Building G, Kitchen, Blue Vinyl Sheeting (Flooring)	Blue Non-Fibrous Homogeneous		40% Ca Carbonate 40% Matrix 20% Non-fibrous (Other)	None Detected
TA-028-Mastic <small>091717700-0003</small>	Building G, Kitchen, Tan and Black Mastic for Vinyl Sheeting & Leveling compound	Tan/Black Non-Fibrous Homogeneous		80% Matrix 20% Non-fibrous (Other)	<1% Chrysotile
TA-028-Leveling Compound <small>091717700-0003A</small>	Building G, Kitchen, Tan and Black Mastic for Vinyl Sheeting & Leveling compound	Gray Non-Fibrous Homogeneous		30% Quartz 50% Ca Carbonate 20% Non-fibrous (Other)	<1% Chrysotile
TA-029 <small>091717700-0004</small>	Building G, MPR, Blue 12"x12" VFT	Blue Non-Fibrous Homogeneous		50% Ca Carbonate 30% Matrix 20% Non-fibrous (Other)	None Detected
TA-030 <small>091717700-0005</small>	Building G, MPR, White 12"x12" VFT	White Non-Fibrous Homogeneous		70% Ca Carbonate 10% Matrix 20% Non-fibrous (Other)	None Detected
TA-031 <small>091717700-0006</small>	Building G, MPR, Mastic for Blue and White VFT	Tan/Black Non-Fibrous Homogeneous	10% Cellulose	10% Ca Carbonate 60% Matrix 20% Non-fibrous (Other)	None Detected
TA-032 <small>091717700-0007</small>	Building G, MPR, Mastic for 4" Gray Baseboard	Beige Non-Fibrous Homogeneous		15% Ca Carbonate 70% Matrix 15% Non-fibrous (Other)	None Detected
TA-033 <small>091717700-0008</small>	Building G, Publishing Center (Classroom) Tan and Black Mastic for Carpet	Tan/Black Non-Fibrous Homogeneous		80% Matrix 20% Non-fibrous (Other)	<1% Chrysotile
TA-034 <small>091717700-0009</small>	Building G, Publishing Center (Classroom) Mastic for 4" Blue Baseboard	Beige Non-Fibrous Homogeneous		15% Ca Carbonate 70% Matrix 15% Non-fibrous (Other)	None Detected
TA-035 <small>091717700-0010</small>	Building H Library, Tan Mastic for Carpet	Tan Non-Fibrous Homogeneous		80% Matrix 20% Non-fibrous (Other)	None Detected
TA-036 <small>091717700-0011</small>	Building H Library, Tan Mastic and Beige Adhesive for 4" Blue Baseboard	Tan/Beige Non-Fibrous Homogeneous		10% Ca Carbonate 70% Matrix 20% Non-fibrous (Other)	None Detected
TA-037-Mastic <small>091717700-0012</small>	Building H Library, RSP Room, Tan Mastic for Carpet & Leveling Compound	Tan Non-Fibrous Homogeneous		80% Matrix 20% Non-fibrous (Other)	None Detected
TA-037-Leveling Compound <small>091717700-0012A</small>	Building H Library, RSP Room, Tan Mastic for Carpet & Leveling Compound	Gray Non-Fibrous Homogeneous		50% Quartz 50% Non-fibrous (Other)	None Detected

Initial report from: 09/15/2017 14:51:58



# EMSL Analytical, Inc.

464 McCormick Street San Leandro, CA 94577

Tel/Fax: (510) 895-3675 / (510) 895-3680

<http://www.EMSL.com> / [sanleandrolab@emsl.com](mailto:sanleandrolab@emsl.com)

**EMSL Order:** 091717700  
**Customer ID:** HAZM63  
**Customer PO:** 17-184  
**Project ID:**

## Test Report: Asbestos Analysis of Bulk Materials via EPA 600/R-93/116 Method using Polarized Light Microscopy

Sample	Description	Appearance	Non-Asbestos		Asbestos
			% Fibrous	% Non-Fibrous	% Type

Analyst(s)

Shane Heisser (14)

Matthew Batongbacal  
or Other Approved Signatory

EMSL maintains liability limited to cost of analysis. This report relates only to the samples reported and may not be reproduced, except in full, without written approval by EMSL. EMSL bears no responsibility for sample collection activities or analytical method limitations. Interpretation and use of test results are the responsibility of the client. This report must not be used by the client to claim product certification, approval, or endorsement by NVLAP, NIST or any agency of the federal government. Non-friable organically bound materials present a problem matrix and therefore EMSL recommends gravimetric reduction prior to analysis. Samples received in good condition unless otherwise noted. Estimated accuracy, precision and uncertainty data available upon request. Unless requested by the client, building materials manufactured with multiple layers (i.e. linoleum, wallboard, etc.) are reported as a single sample. Reporting limit is 1%

Samples analyzed by EMSL Analytical, Inc San Leandro, CA NVLAP Lab Code 101048-3, WA C884

Initial report from: 09/15/2017 14:51:58

091717700

# HazMat Doc

## CHAIN-OF-CUSTODY

JOB # 17-184

CLIENT NAME:	<u>BERRY ESSA UNION SCHOOL DISTRICT</u>	TURNAROUND TIME STANDARD OTHER <u>5 DAY</u>
PROJECT LOCATION:	<u>TOYON ELEMENTARY SCHOOL</u>	
SAMPLED BY:	<u>FBD</u> DATE: <u>09-06-17</u>	

Sample #	Location/Type	Time On Time Off	FLOW RATES			Total Time	PCM	PLM	TEM	LEAD (Air, Paint, Soil, Water, Wipe)
			Start	Stop	Average					
TA-026	Building G, Kitchen, Only Tan and Dark Brown Mastic for 6" Blue								✓ Baseboard	
TA-027	" " Blue Vinyl Sheeting (Flooring)								✓	
TA-028	" " Tan and <del>Dark</del> Black Mastic for Vinyl Sheeting								✓ + leveling compound	
TA-029	" " MPR, Blue 12"x12" VFT								✓	
TA-030	" " White 12"x12" VFT								✓	
TA-031	" " Mastic for Blue and White VFT								✓	
TA-032	" " Mastic for 4" Gray Baseboard								✓	
TA-033	" Publishing Center (classroom), Tan and Black Mastic for Carpet								✓	
TA-034	" " " " Mastic for 4" Blue Baseboard								✓	
TA-035	Building H, Library, Tan Mastic for Carpet								✓	
TA-036	" " Tan Mastic and Beige Adhesive for 4" Blue Baseboard								✓	
TA-037	" RSP Room, Tan Mastic for Carpet + Leveling Compound								✓	

Relinquished By: <u>CC for RM</u>	Date & Time: <u>09-06-17</u>	Received By: <u>KLi</u>	Date & Time: <u>9/9/17 9am</u>
Relinquished By: _____	Date & Time: _____	Received By: _____	Date & Time: _____

**APPENDIX –B**  
**ABATEMENT UNIT PRICES**

**UNIT PRICES**

**ASBESTOS**

<b>Item</b>	<b>Task</b>	<b>Qty</b>	<b>Unit Price</b>	<b>\$ Total</b> (Qty x Unit Price)
1.	Mobilization	2 EA		
2.	Small Containment < 200 SF	2 EA		
3.	Large Containment > 200 SF	2 EA		
4.	Spot Removal (2' x 2')	3 EA		
5.	Small Containment With Hard Barriers	3 EA		
6.	Abate Drywall Board System (Sheetrock, Tape & Mud) Walls and/or Ceilings	100 SF		
7.	Abate Ceiling Tiles and Mastic	100 SF		
8.	Abate Window Sealant	100 LF		
9.	Abate Thermal System Insulation – Pipe Fitting Insulation	5 LF		
10.	Abate Door	1 EA		
	<b>Total Asbestos</b>			

**LEAD**

<b>Item</b>	<b>Task</b>	<b>Qty</b>	<b>Unit Price</b>	<b>\$ Total</b> (Qty x Unit Price)
1.	Mobilization	2 EA		
2.	Small Containment < 200 SF	2 EA		
3.	Remove Metal Roof Components (Jacks, Pipe Sleeves, Drain Pans, etc)	1 EA		
	<b>Total Lead</b>			

**UNIT PRICES**

**MISCELLANEOUS**

<b>Item</b>	<b>Task</b>	<b>Qty</b>	<b>Unit Price</b>	<b>\$ Total</b> (Qty x Unit Price)
1.	Remove and Dispose of Recessed Lighting	1 EA		
2.	Remove and Dispose of Non-PCB Containing Fluorescent Light Fixture Ballast's	10 EA		
3.	Remove and Dispose of PCB Containing Fluorescent Light Fixture Ballast's	10 EA		
4.	Remove and Dispose of Mercury Containing Fluorescent Light Bulbs/Tubes (Standard 48" tubes)	20 EA		
	<b>Total Miscellaneous</b>			

**UNIT PRICE TOTALS**

<b>Task</b>	<b>\$ Total</b>
<b>Total Asbestos</b>	
<b>Total Lead</b>	
<b>Total Miscellaneous</b>	
<b>GRAND TOTAL UNIT PRICE</b>	

**DOCUMENT 00 11 16**

**NOTICE TO BIDDERS**

Notice is hereby given that Berryessa Union School District (hereinafter referred to as “Owner”) will receive sealed bids prior to the date and time stated for the Bid Opening for:

**Berryessa Union School District  
Toyon Elementary School  
955 Bard Street  
San Jose, CA 95127**

**TOYON ELEMENTARY SCHOOL FIS PROJECT** will be constructed utilizing a Single Prime Contractor under contract with the Owner. The Bidder whom is successful and awarded a contract will be referred to as a General Contractor.

As described in more detail in the bidding documents, the following is a list of various Bid Divisions.

**Bids will be received for:**

**TOYON ELEMENTARY SCHOOL: Flexible Instructional Space (FIS)**

Work in the Contract comprises: of modernizing an existing library into a Flexible Learning Space and installation of new finishes. This project includes minor restroom work, striping for accessible parking and replacement of site concrete, asphalt paving. Also included is installation of new ornamental and chain fencing and gates.

**Pre-Bid Conference/Job Site Visit**

Two (2) non-mandatory pre-bid conference/job site visits will be held to familiarize bidders with the project.

TOYON ELEMENTARY SCHOOL F.I.S. Pre-Bid conference

**Job Site Visit #1 will be conducted on, October 11, 2018 @ 3:00 pm**

**Job Site Visit #2 will be conducted on, October 18, 2018 @ 3:00 pm**

**Pre-Bid conferences/job site visits will start at:**

**Toyon Elementary School, 995 Bard St, San Jose, CA 95127**  
Assemble in the parking lot on Bard Ave, under the shade structures.



The lowest bid shall be determined:

1. On the amount of the base bid including contract allowance.

### **Pre-Bid Questions/RFI's**

Requests for clarification or interpretation of the Bidding Documents must be in writing and received no later than:

October 23, 2018 at 5:00pm.

All questions shall be sent in writing and via email to the attention of Mark Casini, with Kitchell CEM, [mcasini@kitchell.com](mailto:mcasini@kitchell.com), or James Wilson, [jmwilson@kitchell.com](mailto:jmwilson@kitchell.com)

### **Submission of Bids**

Sealed bids for the Lump Sum Base Bid for each Bid Division must be received at:

Berryessa Union School District  
Bond Office  
1376 Piedmont Road  
San Jose, CA 95132

**Before 1:00 pm on Wednesday, October 31, 2018**

### **Faxed Bids Will Not Be Accepted**

Bids shall not expire for a period of 90 days after the date set for bid submission.

The Owner reserves the right to add or deduct any of the additive or deductive items after the lowest responsible and responsive bidder is determined.

This Project is subject to prequalification. If a bidder is not prequalified to bid on the Project, Owner will not accept the bid. The prequalification package is available at the BUSD website. Prequalification packages must be received at BUSD as follows: **10 days prior to receiving bids.**

**AB1565: This project is subject to Prequalification.** If the bidder is not prequalified to bid on the Project, Owner will not accept the bid. Any M/E/P subcontractors the bidder lists for work must have current prequalified status with owner. Prequalification documents are available for download at [www.berryessa.k12.ca.us](http://www.berryessa.k12.ca.us). Click the link for "Contractor Prequalification" under the Purchasing Department Page.

**Addendum**

Revisions, additions or deletions will be made by written addenda only as issued by Kitchell and McKim Design Group. The last Addendum, if any, will be issued on/or before **October 26, 2018.**

**Basis of Award**

Kitchell and the Owner will award the Bid Division contracts in accordance with Section 00 21 13 Instructions to Bidders.

**Contractor's License**

The successful Bidder will be required to have the appropriate State of California Contractor's License current at the time of submission of Bid.

**Class B License**

**Project Documents**

Project Bidding Documents will be available for download at:

<http://www.berryessa.k12.ca.us/OUR-DISTRICT/Business-Services/Purchasing/Current-Bids/index.html>

For public works contracts awarded on and after January 1, 2015, those public works projects shall be subject to compliance monitoring and enforcement by the Department of Industrial Relations.

As of March 1, 2015, a contractor or subcontractor shall not be qualified to submit a bid or to be listed in a bid proposal subject to the requirements of Public Contract Code section 4104 unless currently registered and qualified under Labor Code section 1725.5 to perform public work as defined by Division 2, Part 7, Chapter 1 (§§1720 et seq.) of the Labor Code.

As of April 1, 2015, a contractor or subcontractor shall not be qualified to enter into, or engage in the performance of, any contract of public work (as defined by Division 2, Part 7, Chapter 1 (§§1720 et seq.) of the Labor Code) unless currently registered and qualified under Labor Code section 1725.5 to perform public work.

**Schedule**

Duration for completing the Toyon Elementary School FIS Project shall be Ninety-six (96) calendar days from the Notice to Proceed:

**FIS:** 96 calendar days from the Notice to Proceed.

**Site work:** (including all demolition, underground work, concrete, asphalt replacement, striping and fencing/gate installation): shall start on 12/24/2018 and be complete by 2/6/2018

**Bids will be opened, sealed and filed in the Purchasing Department of the Owner at:**

**Berryessa Union School District  
1376 Piedmont Road  
San Jose, CA 95132**

**On Wednesday, October 31, 2018, before 1:00 p.m. on the clock designated by the Owner or its representative as the bid clock. Facsimile (FAX) copies of the bid will not be accepted.**

The Owner will require the successful Bidder to achieve the minimum goal of 3% DVBE (Disabled Veteran Business Enterprises) established in the bidding documents or to provide acceptable evidence of good faith efforts to do so at time of submitting your Agreement with the Owner.

Bids must be accompanied by a bidder's bond, cashier's check, or certified check for at least ten percent (10%) of the amount of the base bid and made payable to the Owner. If a bid bond is used, it must be issued by an Admitted Surety (an insurance organization authorized by the Insurance Commissioner to transact surety insurance in the State of California during this calendar year), which shall be given as a guarantee that the bidder will enter into a Contract if awarded the Work and will be declared forfeited, paid to, or retained by the Owner as liquidated damages if the bidder refuses or neglects to enter into the Contract provided by the Owner after being requested to do so. The surety insurer must, unless otherwise agreed to by Owner in writing, at the time of issuance of the bond, have a rating not lower than "A-" as rated by A.M. Best Company, Inc. or other independent rating companies. Owner reserves the right to approve or reject the surety insurer selected by Contractor and to require Contractor to obtain a bond from a surety insurer satisfactory to the Owner.

Bids must be accompanied by an executed Fingerprinting Notice and Acknowledgment.

Pursuant to the Contract Documents, the successful bidder will be required to furnish a Payment (Labor and Material) Bond in the amount of one hundred percent (100%) of the Contract Sum, and a Faithful Performance Bond in the amount of one hundred percent (100%) of the Contract Sum, said bonds to be secured from Admitted Surety insurers (an insurance organization authorized by the Insurance Commissioner to transact business of insurance in the State of California during this calendar year). The surety insurers must, unless otherwise agreed to by Owner in writing, at the time of issuance of the bonds, have a rating not lower than "A-" as rated by A.M. Best Company, Inc. or other independent rating companies. Owner reserves the right to approve or reject the surety insurers selected by the successful bidder and to require the successful bidder to obtain bonds from surety insurers satisfactory to the Owner. The bidder will be required to furnish insurance as set forth in the Contract Documents.

The successful bidder will be allowed to substitute securities or establish an escrow in lieu of retainage, pursuant to Public Contract Code Section 22300, and as described in the Agreement Between Owner and Contractor and General Conditions.

The Owner will not consider or accept any bids from contractors who are not licensed to do business in the State of California, in accordance with the California Public Contract Code, providing for the licensing of contractors. In accordance with Section 3300 of said Code, the bidder shall have a "Class X for Modernization and F.I.S." license and shall maintain that license in good standing through Project completion and all applicable warranty periods. Bidder shall state the California contractor license number on the Designation of Subcontractors form for all subcontractors doing more than one-half of one percent (0.5%) of the bidder's total bid. An inadvertent error in listing a California contractor's license number shall not be grounds for filing a bid protest or for considering the bid nonresponsive if the bidder submits the corrected contractor's license number to the Owner within 24 hours after the bid opening, or any continuation thereof, so long as the corrected contractor's license number corresponds to the submitted name and location for that subcontractor.

Subcontractors shall maintain their licenses in good standing through Project completion and all applicable warranty periods. Owner reserves the right to reject any bid as nonresponsive if bidder or any subcontractor is not licensed in good standing from the time the bid is submitted to Owner up to award of the Contract, whether or not the bidder listed the subcontractor inadvertently, or if a listed subcontractor's license is suspended or expires prior to award of the Contract. Owner also reserves the right to reject any bid as non responsive if a listed subcontractor's license is not in good standing to perform the work for which it is listed from the time of submission of the bidder's bid to award of the Contract.

The Director of Industrial Relations of the State of California, in the manner provided by law, has ascertained the general prevailing rate of per diem wages and rate for legal holidays and overtime work. The Contractor must pay for any labor therein described or classified in an amount not less than the rates specified. Copies of the required rates are on file at the Owner's business office and are available to any interested party on request.

The Owner reserves the right to waive any irregularity and to reject any or all bids.

Unless otherwise required by law, no bidder may withdraw its bid for a period of ninety (90) days after the date set for the opening thereof or any authorized postponement thereof. The Owner reserves the right to take more than ninety (90) days to make a decision regarding the rejection of bids or the award of the Contract.

Advertise:	1st Publication Date	October 9, 2018
	2nd Publication Date	October 16, 2018

END OF DOCUMENT



NOTE:  
REMOVE EXIST. ASP. PAVING  
EXCEPT AS INDICATED

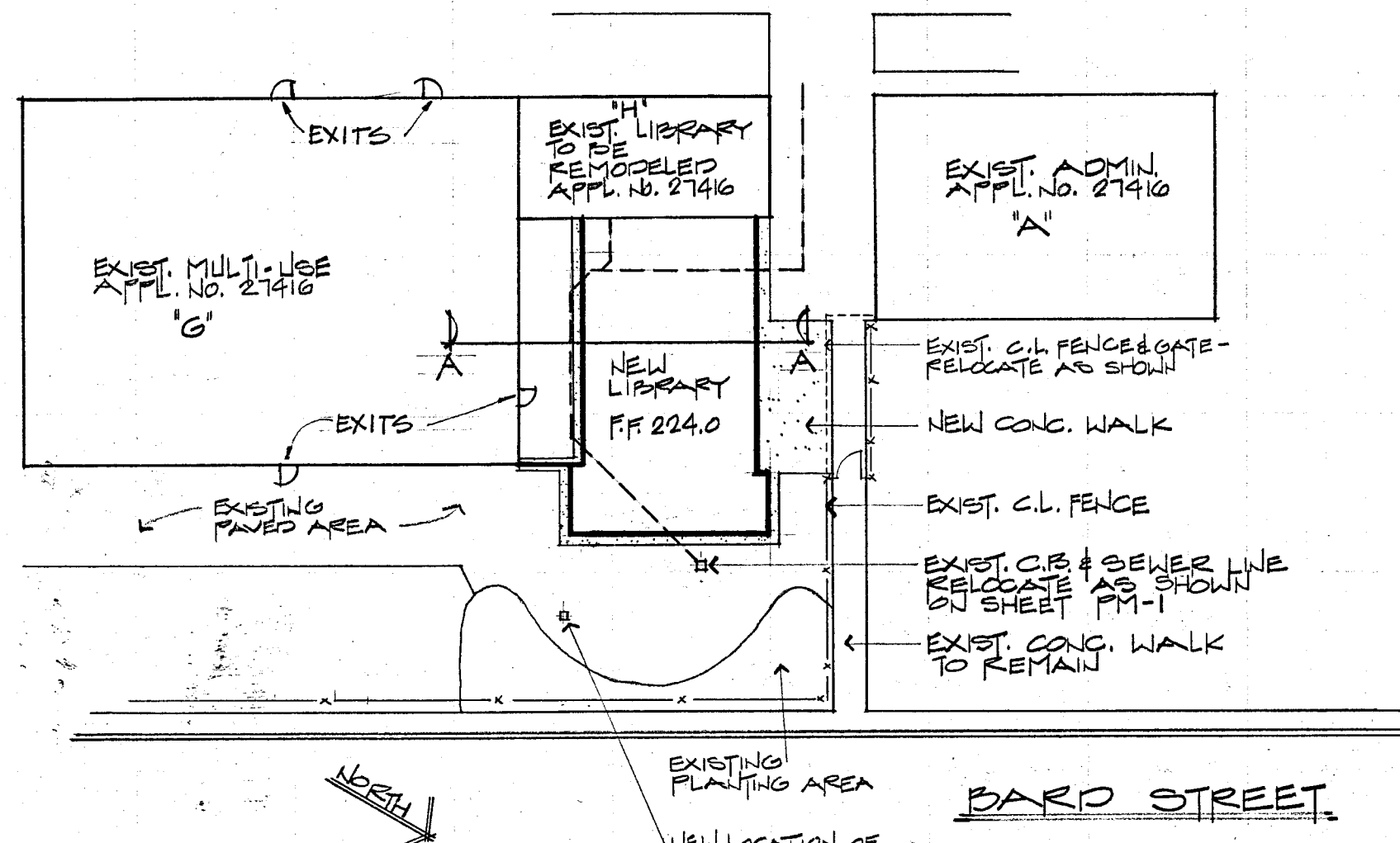

SITE PLAN 1"=20'-0"

**EXISTING MULTI-USE**  
GROUP B-2  
TYPE V-1 HOUR  
SINGLE STORY  
MAX. HEIGHT 18'-0"  
AREA - 6200 SQ. FT.

**NEW LIBRARY ADDITION**  
GROUP C  
TYPE V-1 HOUR  
SINGLE STORY  
MAX. HEIGHT 15'-0"  
AREA - 3200 SQ. FT.  
(INCLUDES REMODELED AREA)

TOTAL BUILDING AREA 9400 SQ. FT.  
ALLOWABLE AREA : 7900 X 1.25 = 10500

**BUILDING ANALYSIS**

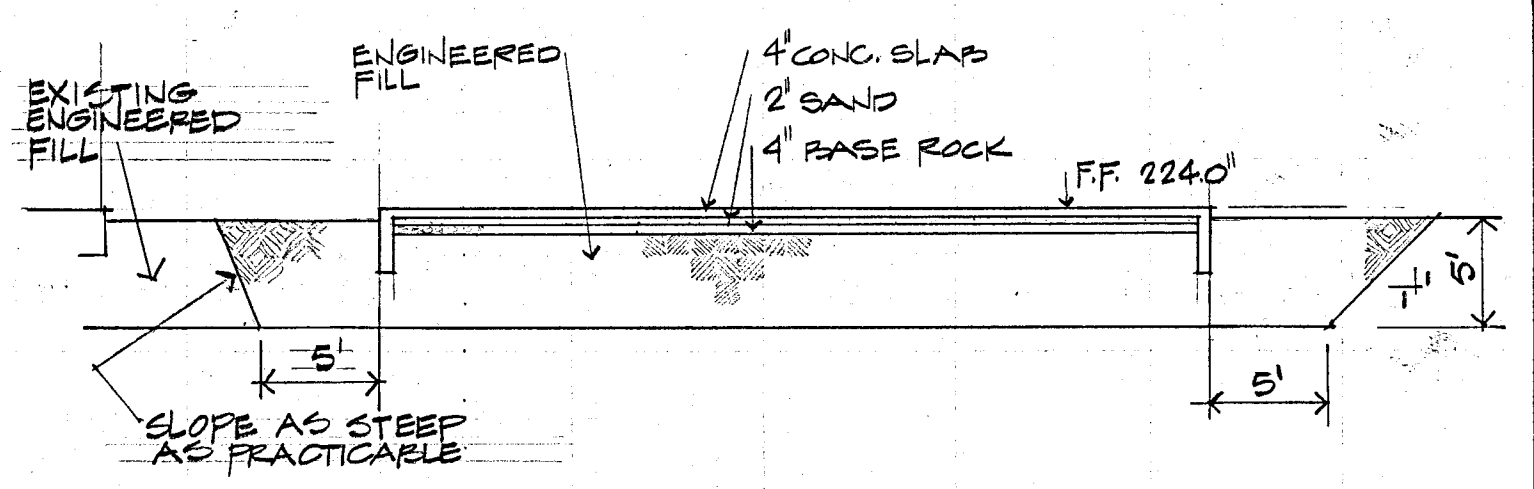

GRADING SECTION A-A

- NOTES & LEGEND**
- (23) ROOM NO.
  - (10) DOOR NO.
  - PC PREFINISHED CABINET
  - PM PREFINISHED MOBILE CABINET
  - △ PLAN NOTE NO.
  - K FACE DIMENSION
  - CENTERLINE DIMENSION
  - SECTION NUMBER
  - △ SHEET NUMBER (WHERE DRAWN)
  - DETAIL NUMBER
  - △ SHEET NUMBER (WHERE DRAWN)

**NOTES & LEGEND**

- A 1 TITLE SHEET, SITE PLAN, FLOOR PLAN, CEILING PLAN, INTERIOR ELEVATIONS
- A 2 EXTERIOR ELEVATIONS, 1/2" SECTIONS, 3/4" SECTIONS, DETAILS
- A 3 DETAILS
- S 1 GENERAL NOTES, TYPICAL DETAILS
- S 2 FOUNDATION & ROOF FRAMING PLANS, FOUNDATION DETAILS
- S 3 STRUCTURAL DETAILS
- PM 1 FLOOR & ROOF PLANS
- PM 2 DETAILS & SECTIONS
- E 1 SITE PLAN, LIGHTING & POWER FLOOR PLANS, SCHEDULES & DETAILS

DRAWING INDEX

1. ITEMS OF MECHANICAL AND/OR ELECTRICAL NATURE OR STRUCTURAL DETAIL MAY NOT NECESSARILY BE SHOWN ON THE ARCHITECTURAL DRAWINGS. SEE THE APPROPRIATE DRAWINGS FOR ITEMS OF THIS NATURE.
2. SEE SPECIFICATIONS FOR ITEMS SUBJECT TO DEFERRED APPROVAL. THESE INCLUDE, BUT ARE NOT LIMITED TO:
  - a. SUSPENDED TEE-BAR CEILING SYSTEMS
  - b. VIBRATION ISOLATORS

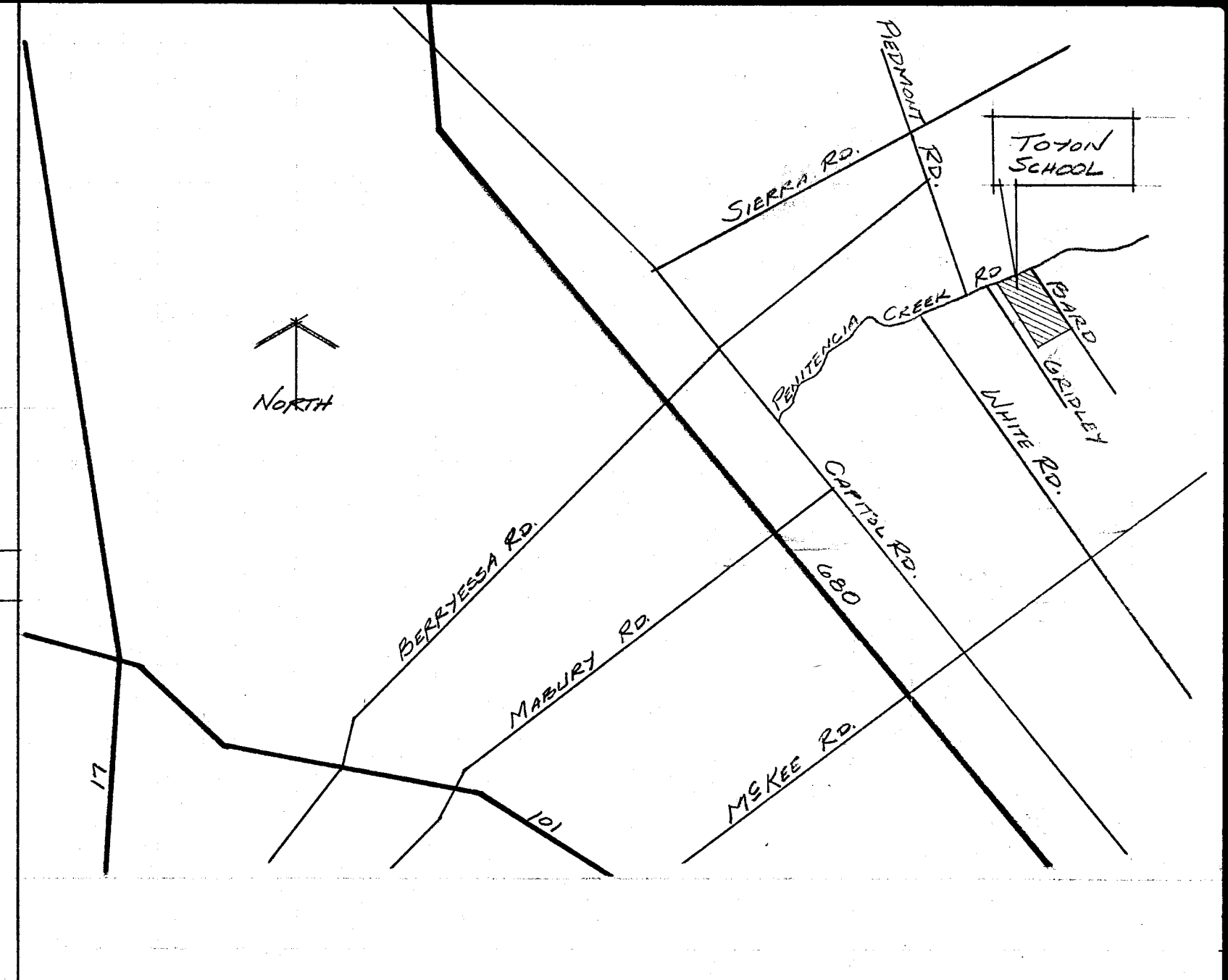

AREA MAP (PORTION OF NORTHEAST SAN JOE)

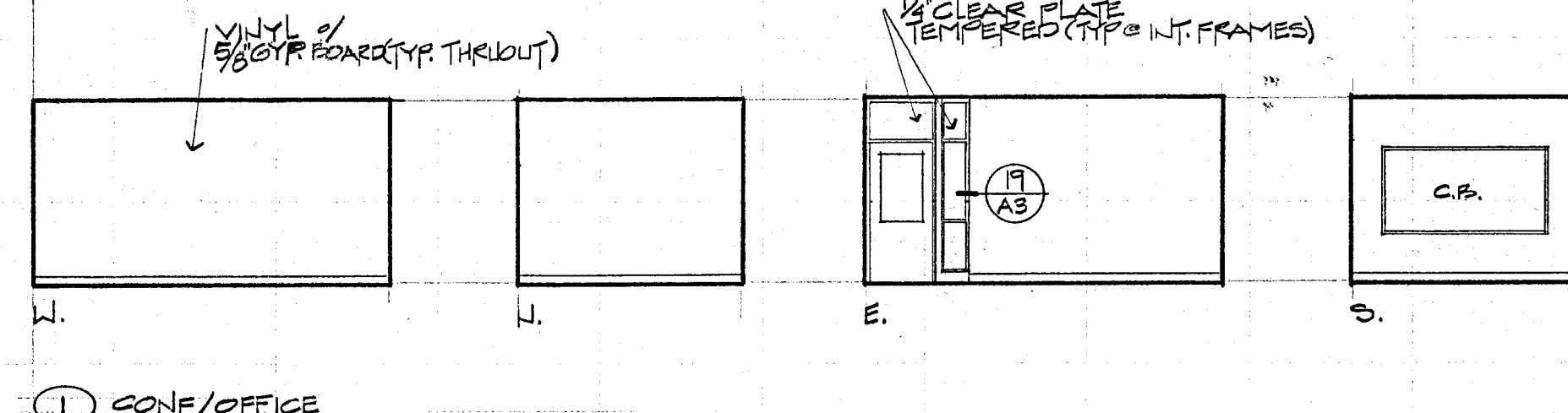

1 CONF/OFFICE

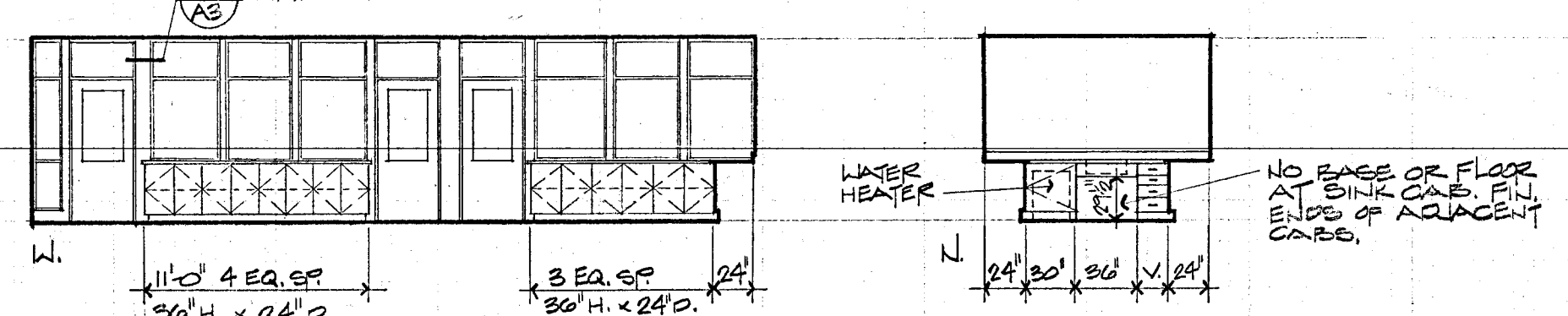

2 CHECK OUT

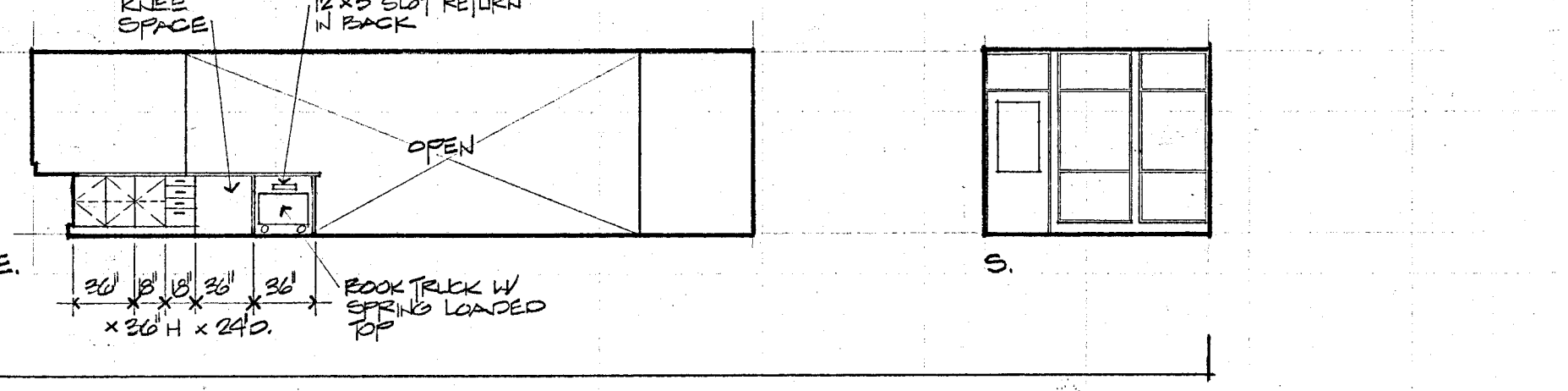

6 LIBRARY

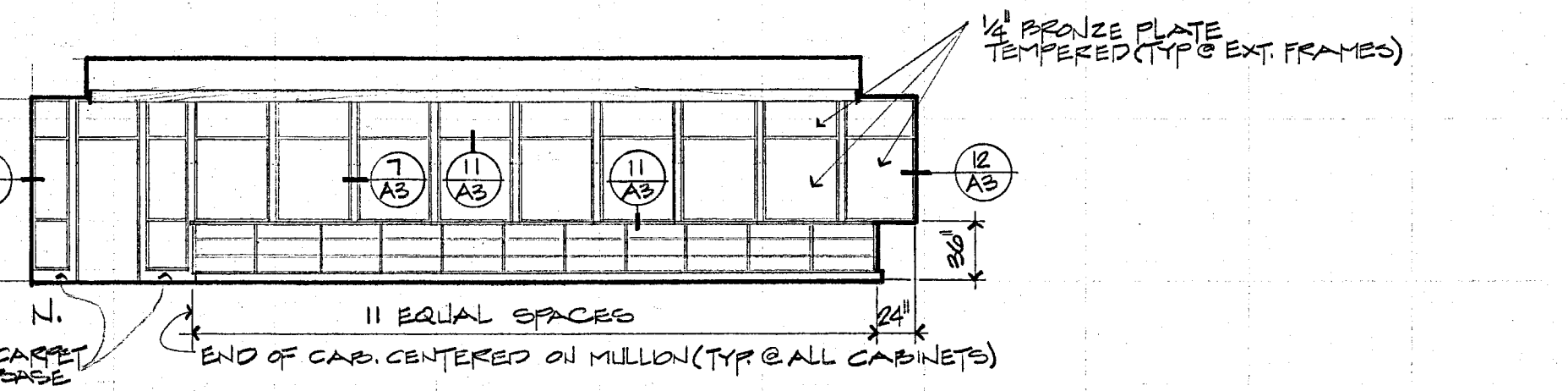

7 READING SPECIALIST

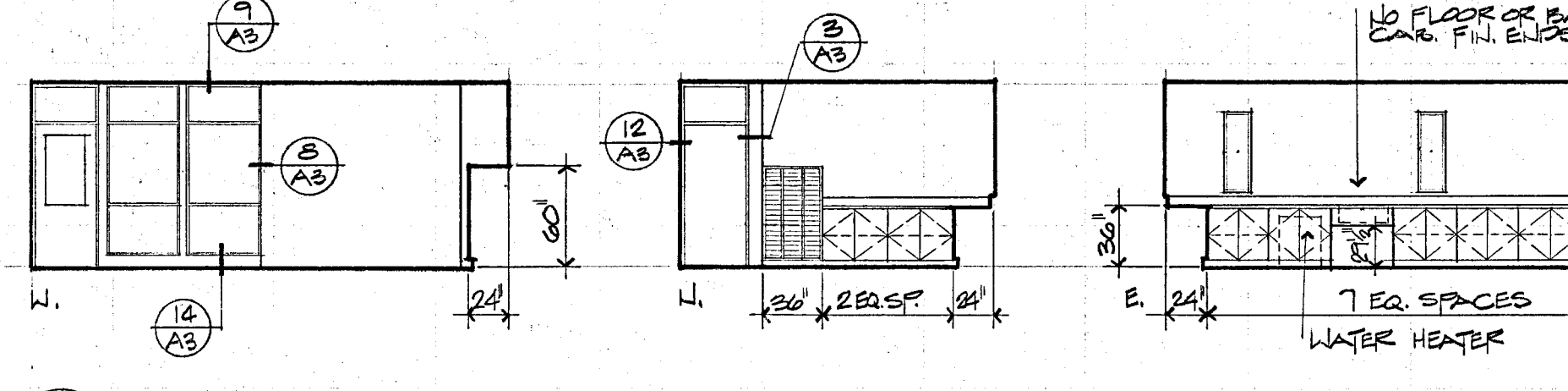

8 LEARNING DISABILITY

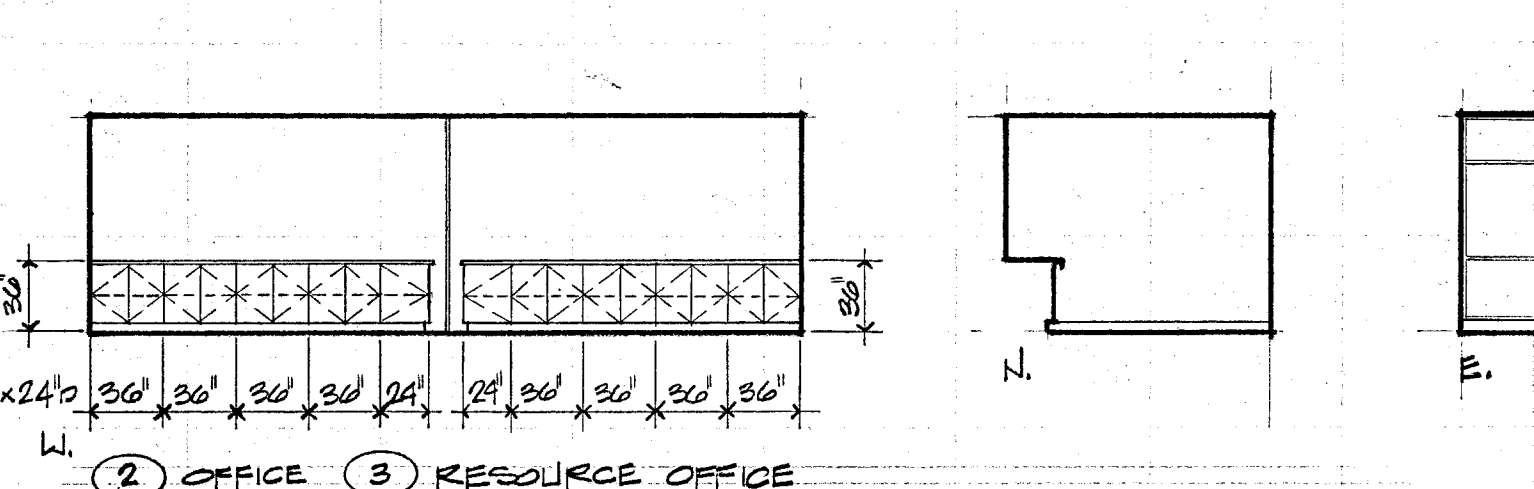

2 OFFICE 3 RESOURCE OFFICE

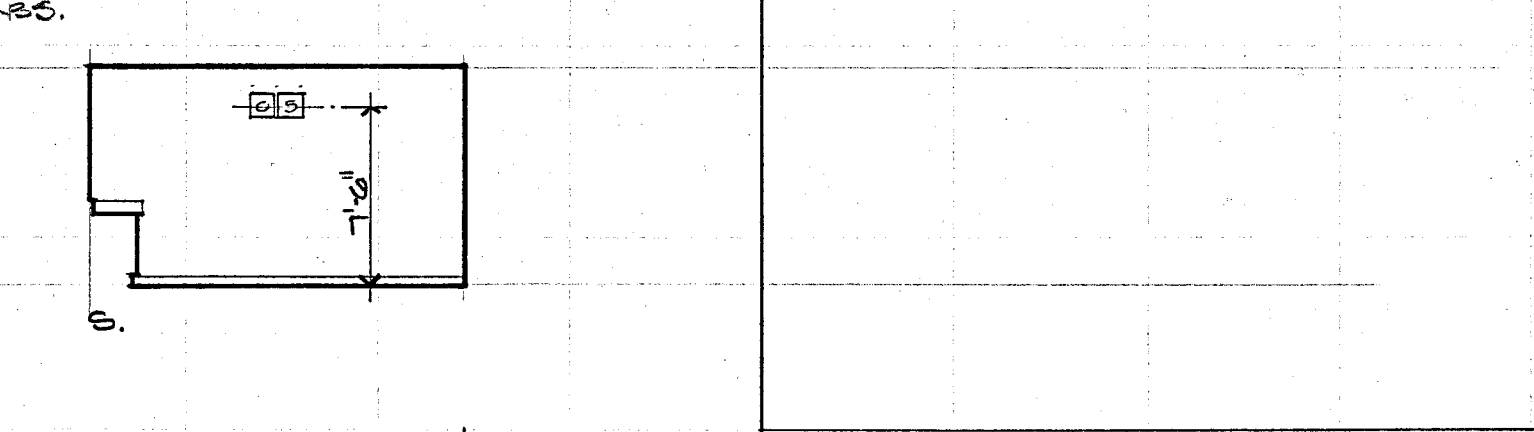
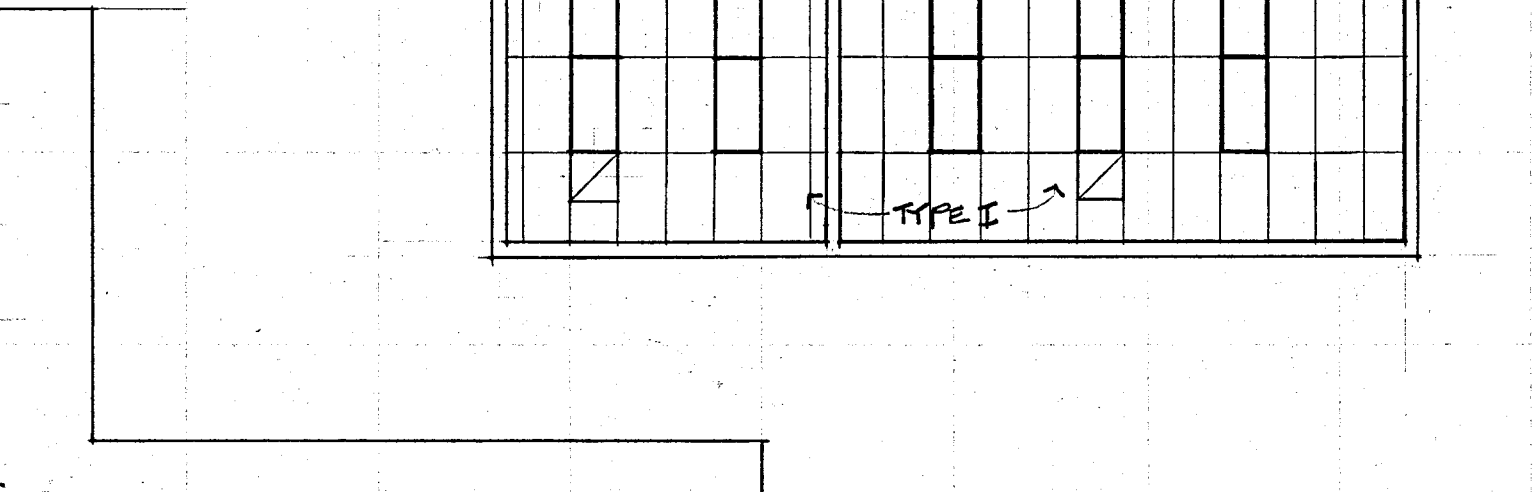
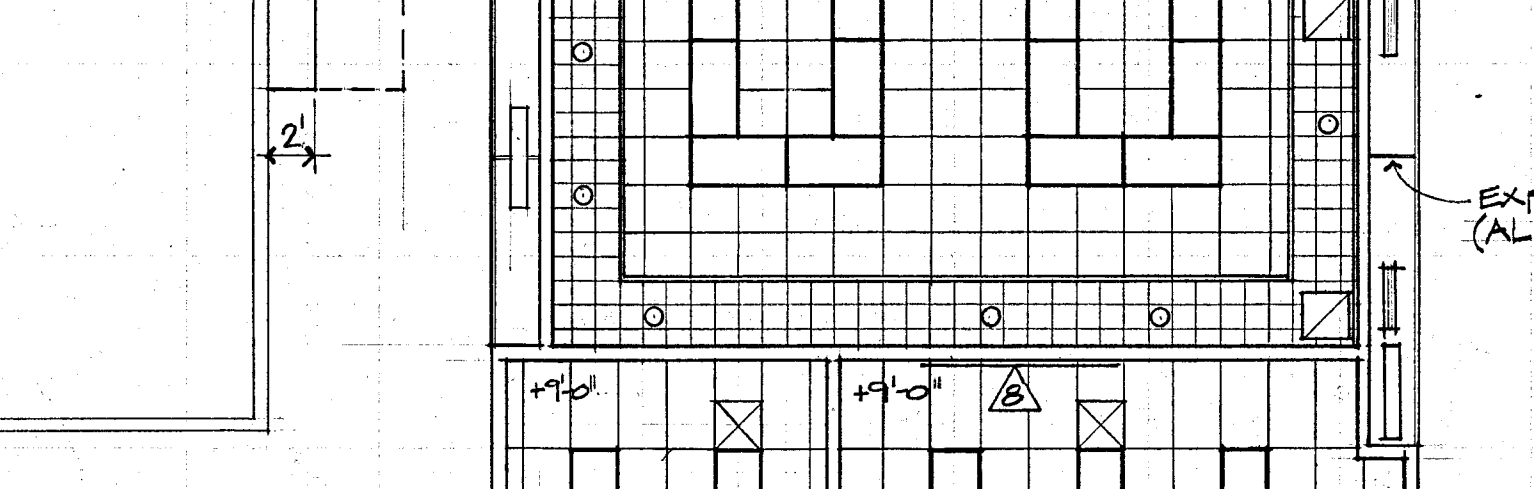
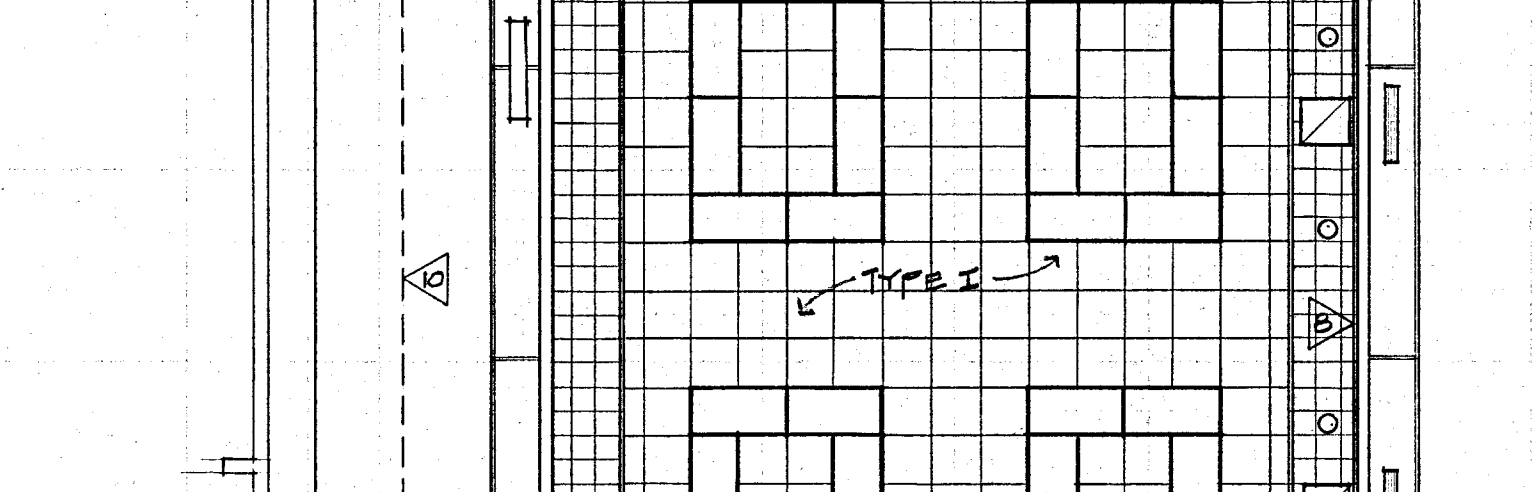
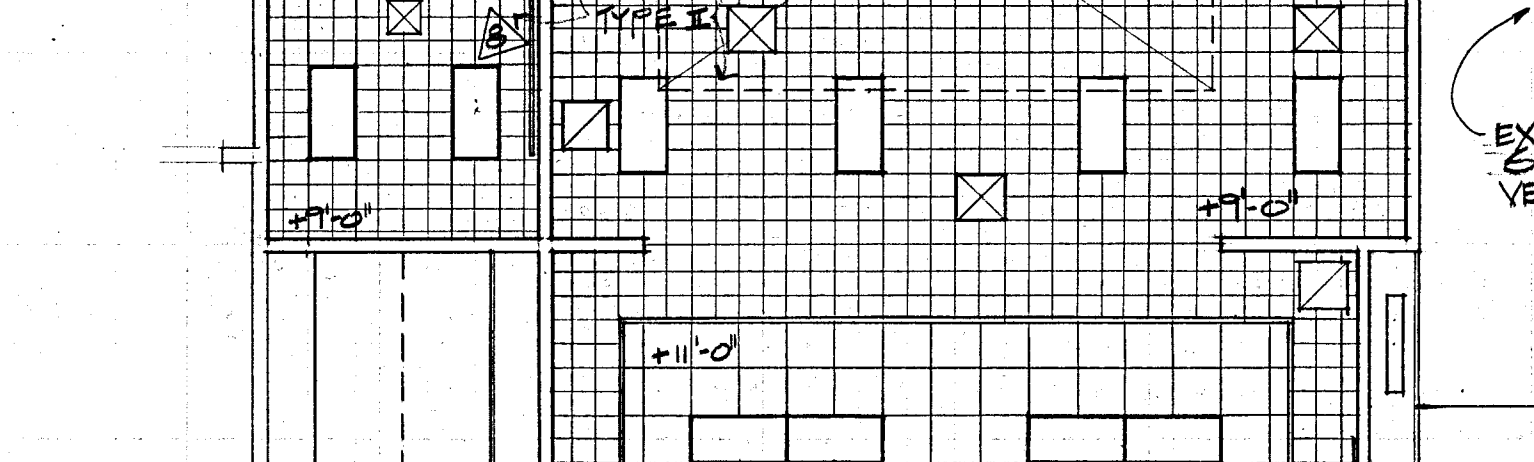
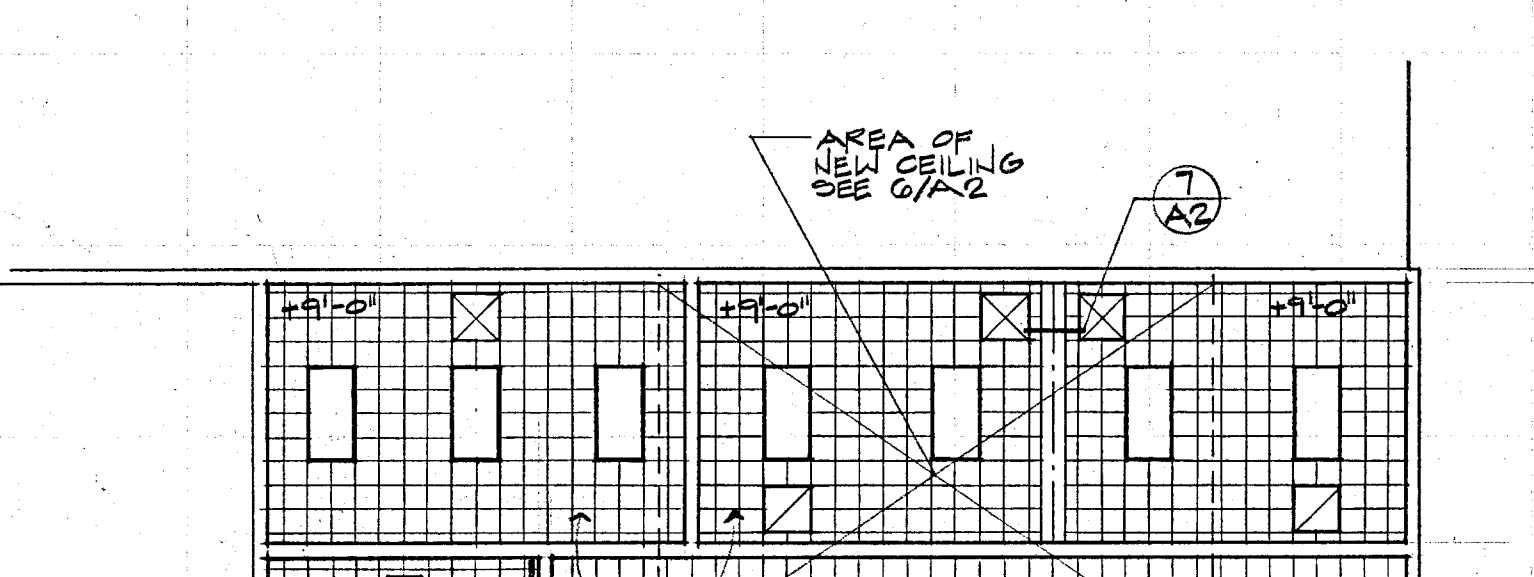
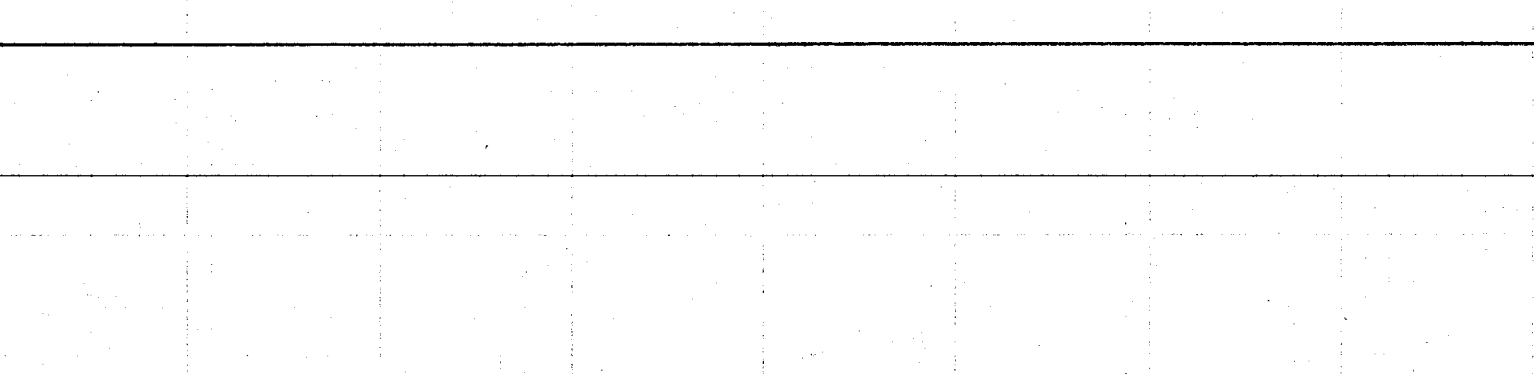

CEILING PLAN

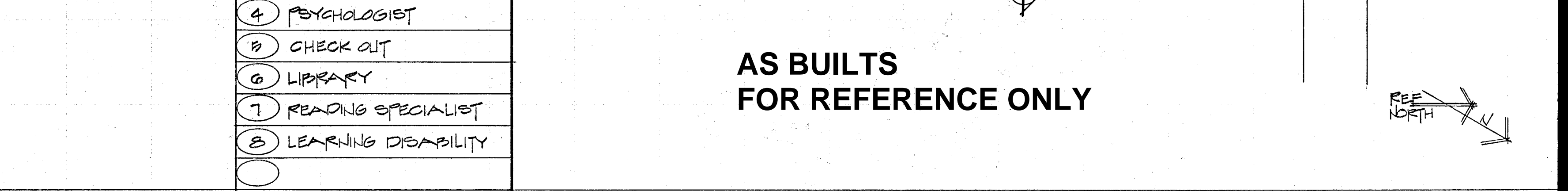
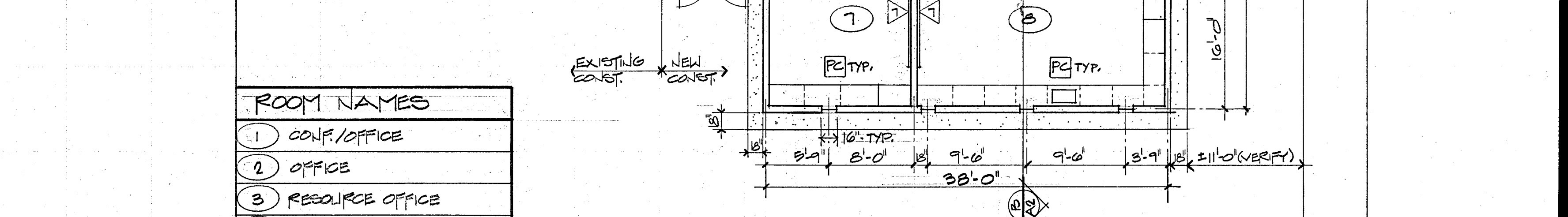
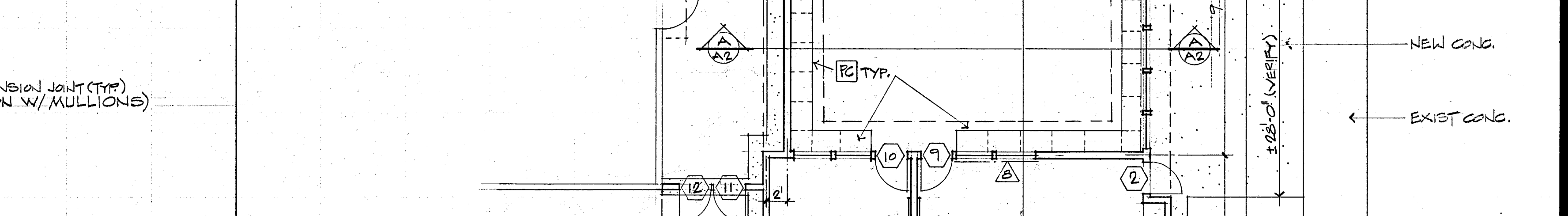
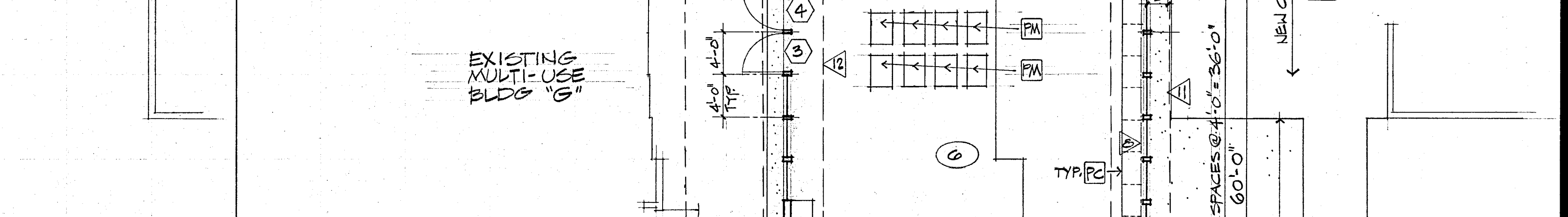
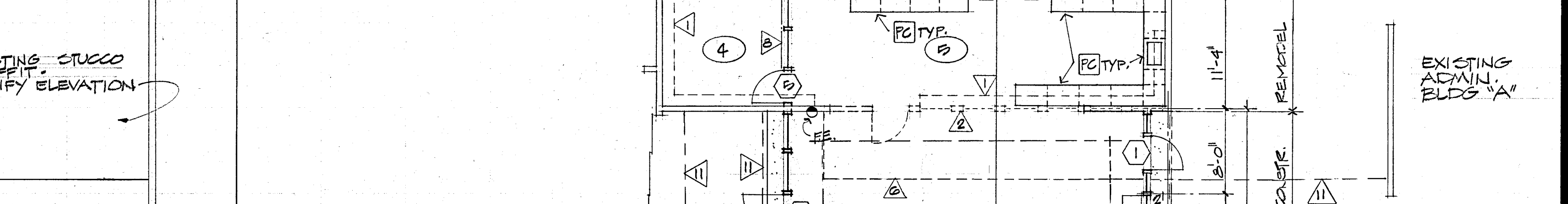
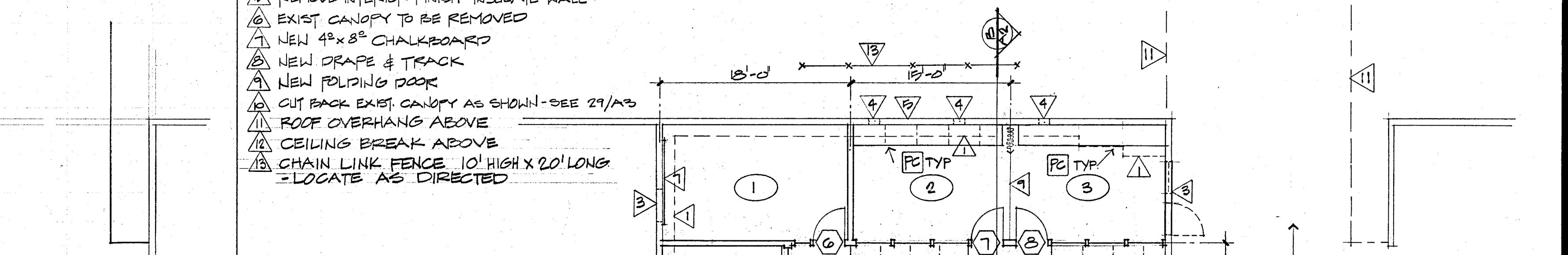
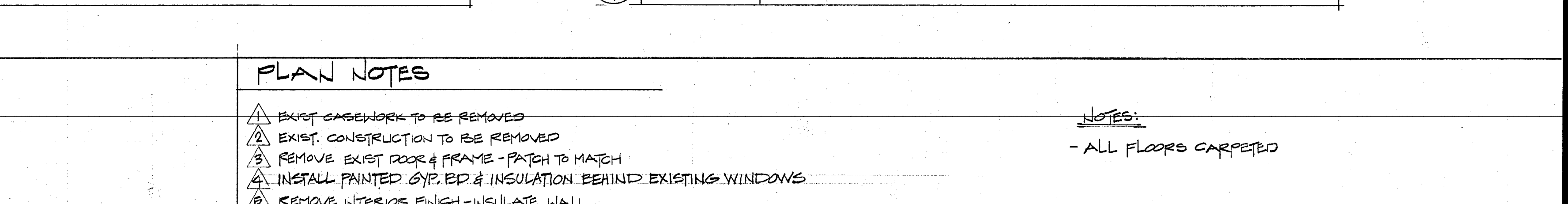
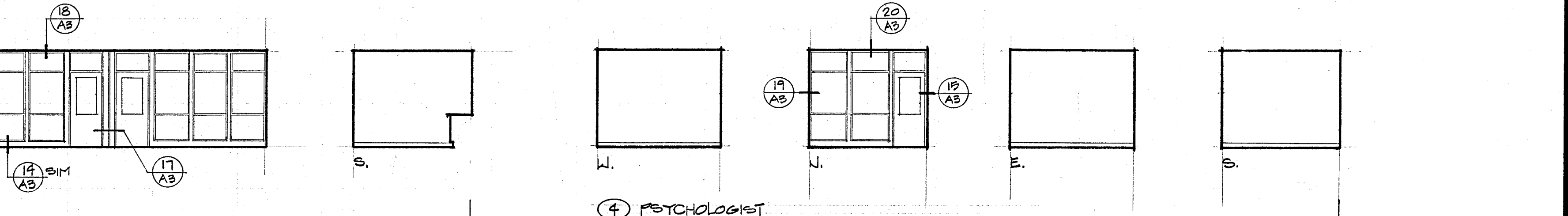

**PLAN NOTES**

- △ EXIST. CASEWORK TO BE REMOVED
- △ EXIST. CONSTRUCTION TO BE REMOVED
- △ REMOVE EXIST. DOOR & FRAME - PATCH TO MATCH
- △ INSTALL PAINTED GYP. BD & INSULATION BEHIND EXISTING WINDOWS
- △ REMOVE INTERIOR FINISH - INSULATE WALL
- △ EXIST. CANOPY TO BE REMOVED
- △ NEW 4" X 8" CHALKBOARD
- △ NEW DRAPE & TRACK
- △ NEW FOLDING DOOR
- △ CUT BACK EXIST. CANOPY AS SHOWN - SEE 29/A3
- △ ROOF OVERHANG ABOVE
- △ CEILING BREAK ABOVE
- △ CHAIN LINK FENCE 10' HIGH X 20' LONG - LOCATE AS DIRECTED

NOTES:  
- ALL FLOORS CARPETED

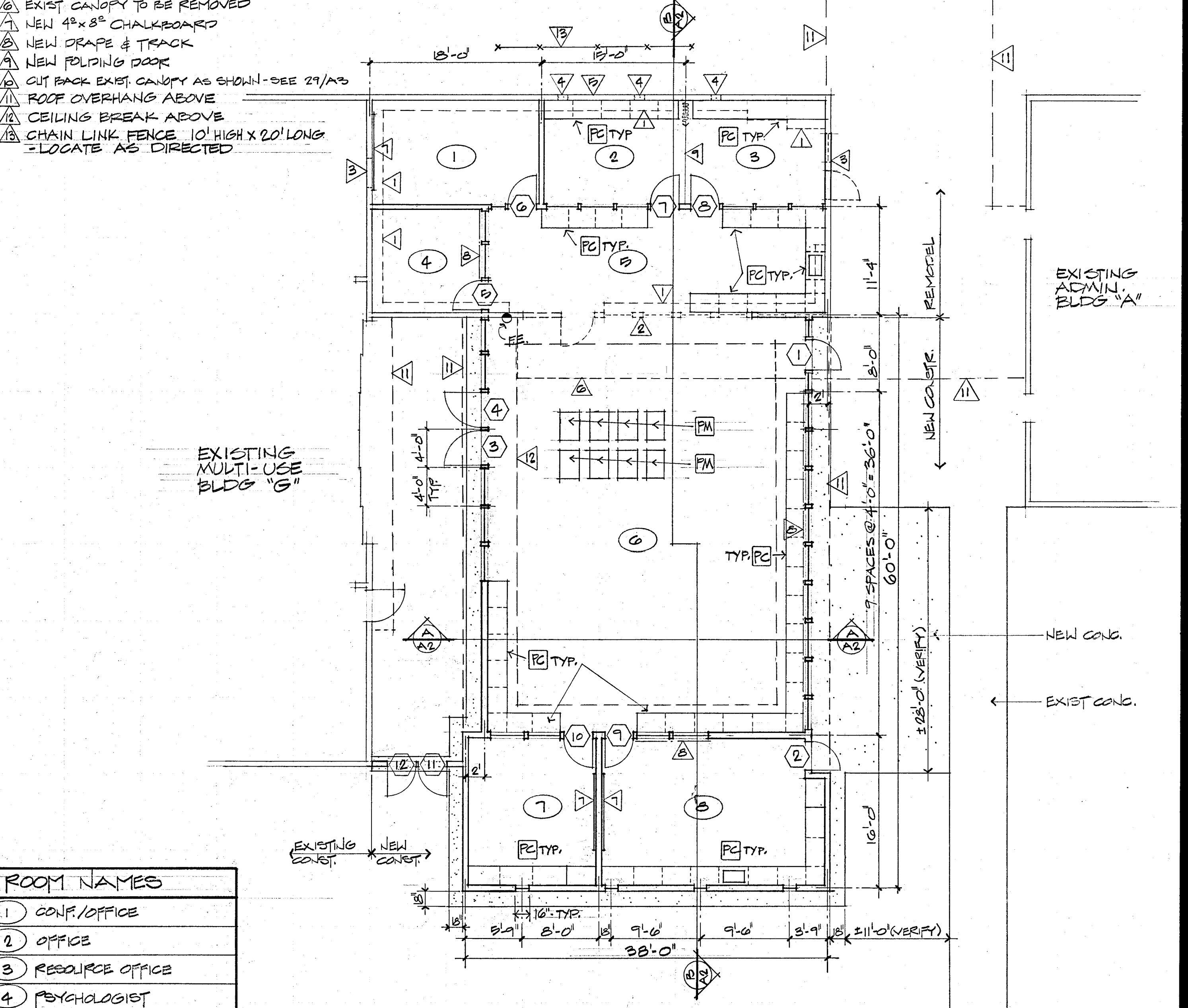
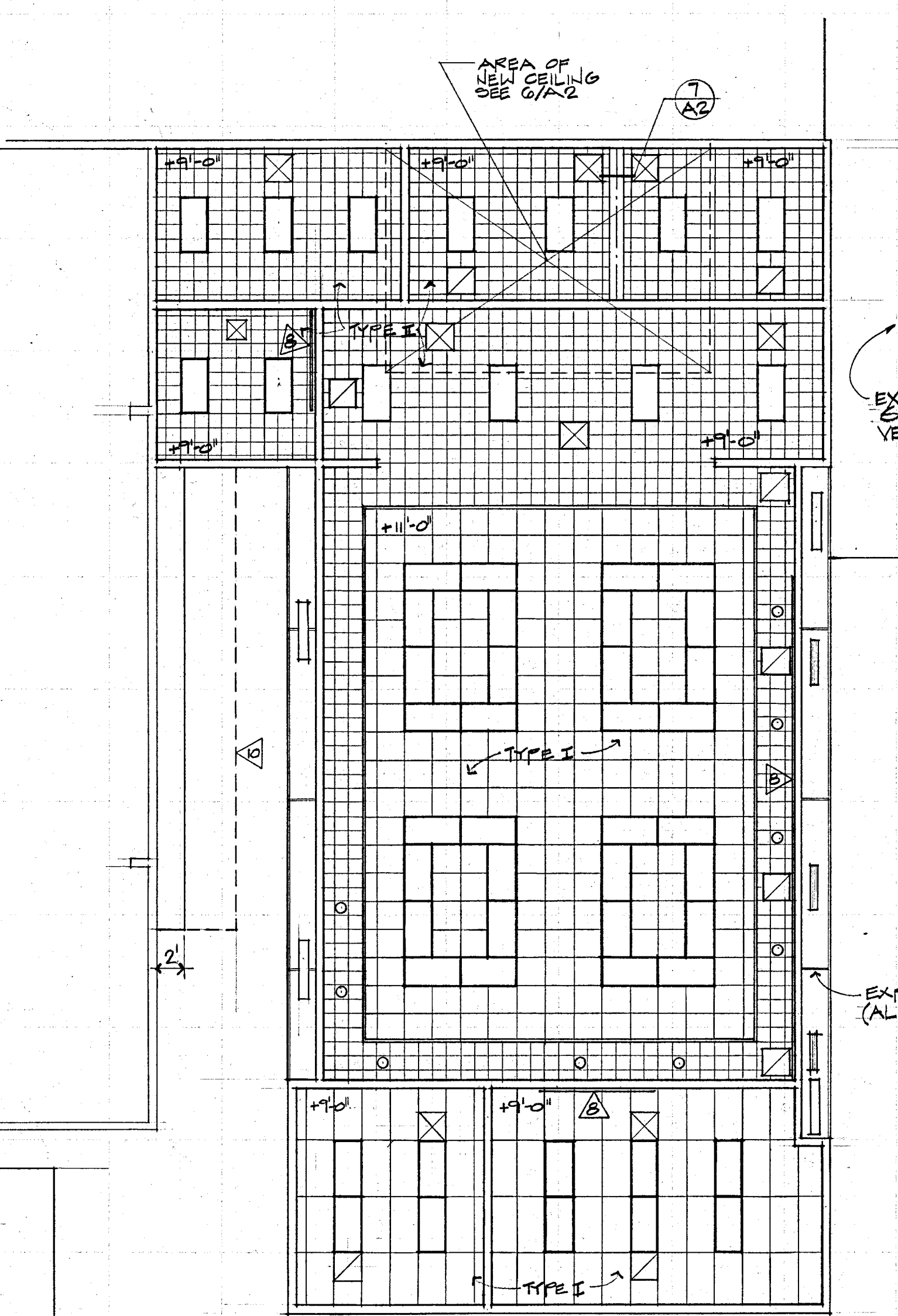

- ROOM NAMES**
- 1 CONF/OFFICE
  - 2 OFFICE
  - 3 RESOURCE OFFICE
  - 4 PSYCHOLOGIST
  - 5 CHECK OUT
  - 6 LIBRARY
  - 7 READING SPECIALIST
  - 8 LEARNING DISABILITY

FLOOR PLAN

AS BUILT  
FOR REFERENCE ONLY



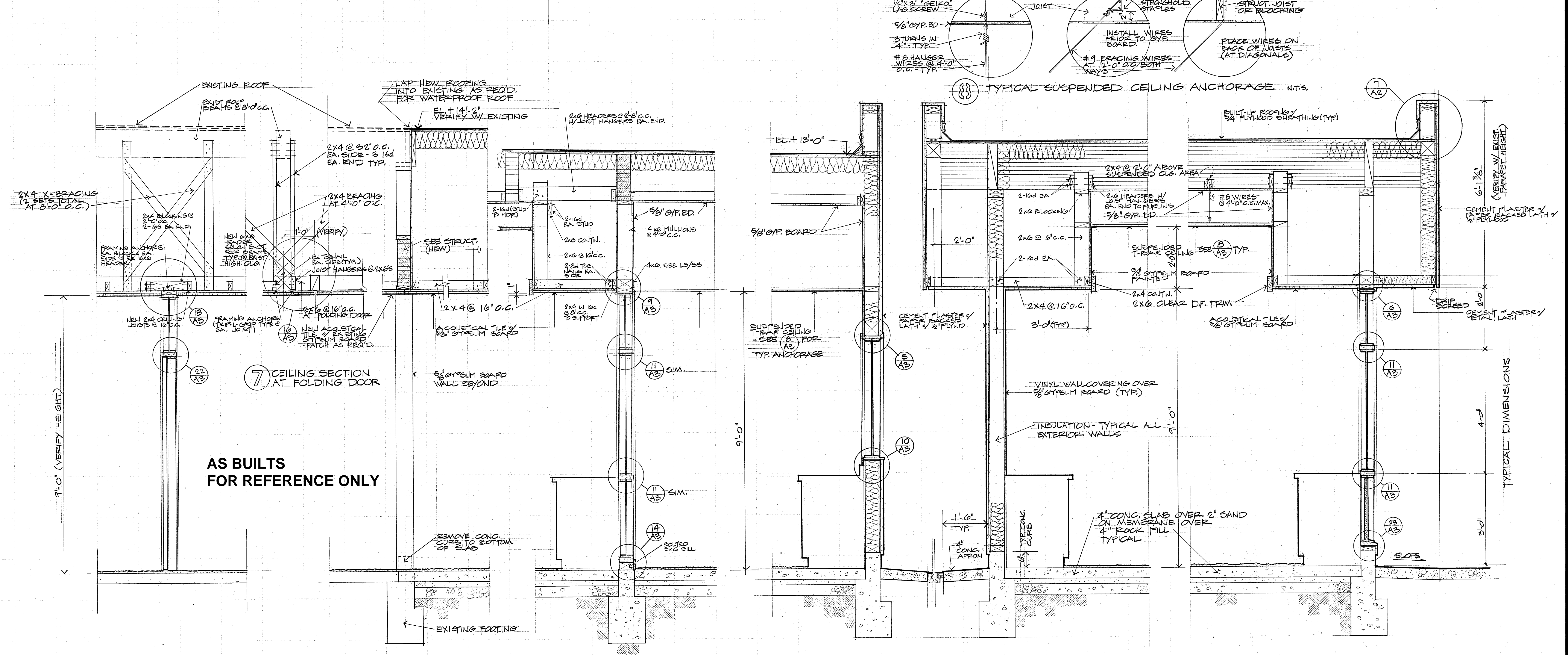
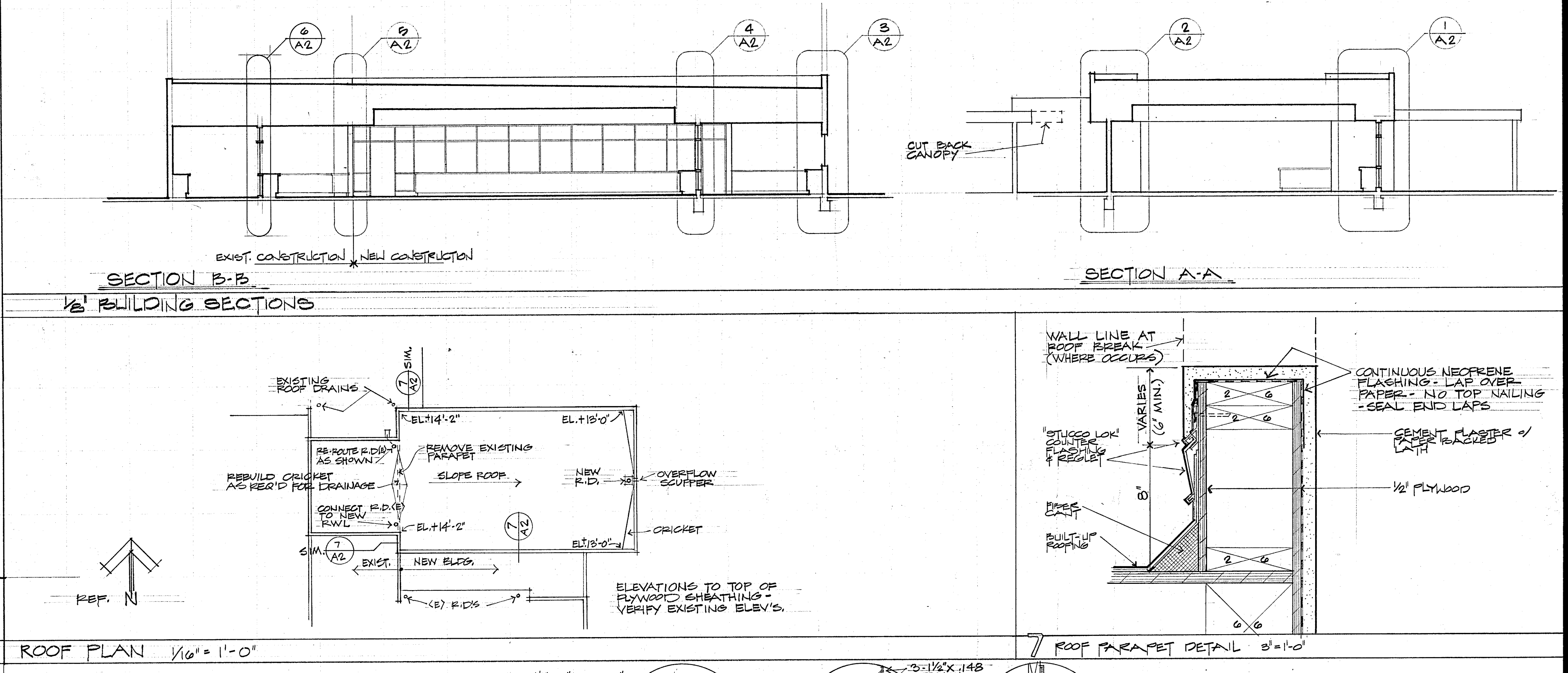
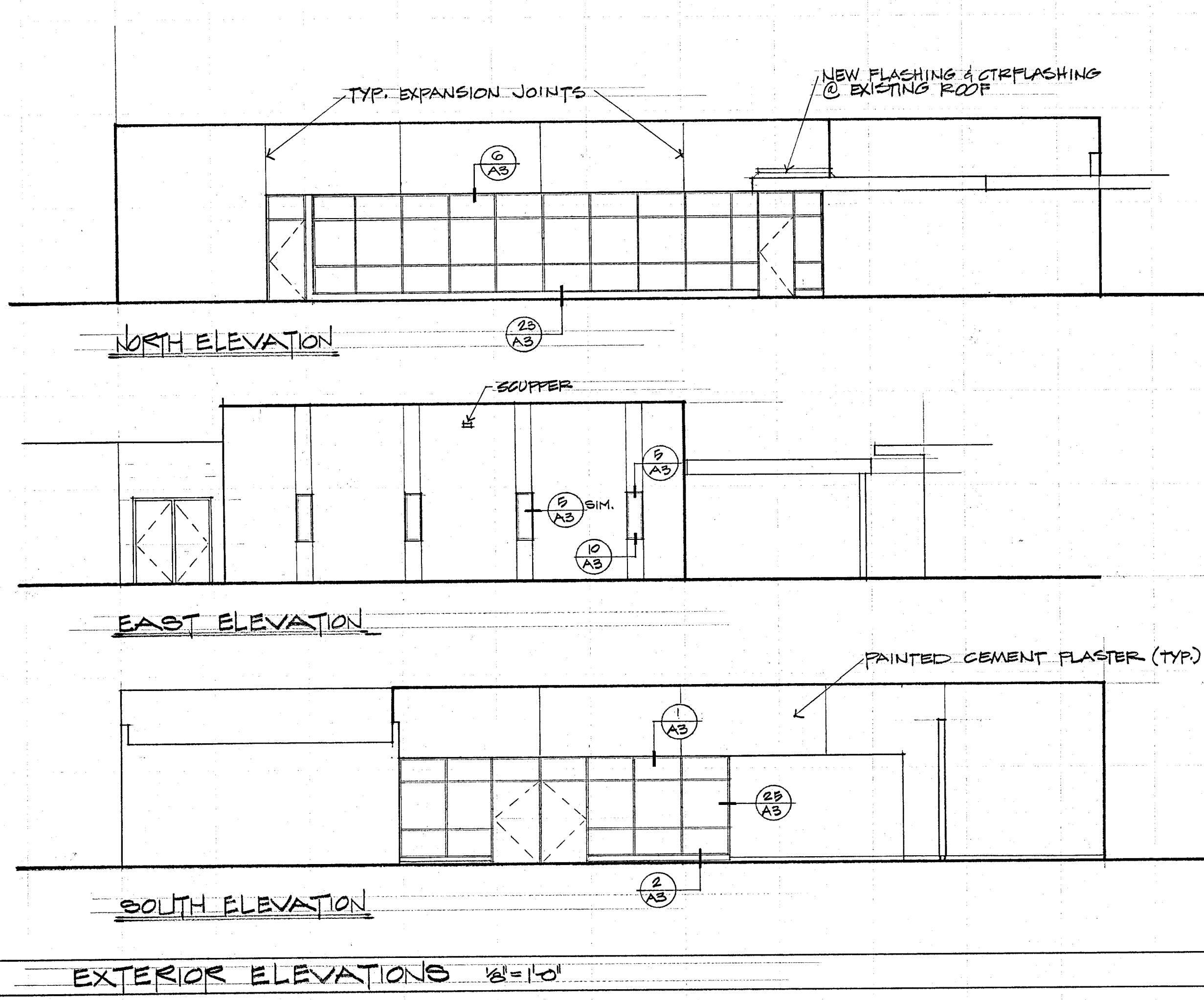

**DR. JESSE PORTER · JENSEN · HANSEN · MANZAGOL**  
ARCHITECTS, A.I.A.  
405 WASHINGTON STREET, SANTA CLARA, CALIFORNIA 95050

DATE: MAR 15 1984  
DRAWN BY: JAG  
CHECKED BY: JPH  
SCALE: AS NOTED

EXTERIOR ELEVATIONS 1/8" = 1'-0"  
1/2" SECTIONS 1/16" = 1'-0"  
3/4" SECTIONS 3/4" = 1'-0"  
DETAILS AS NOTED

LIBRARY ADDITION TO  
TOYON ELEMENTARY SCHOOL  
PERKINS+KILLAM ARCHITECTS  
SAN JOSE, CALIFORNIA



SPRNG. NO.	ROOM NO.	SIZE		CONJT.	DETAILS		REMARKS
		WIDTH	HEIGHT		DOOR MATERIAL	FRAME MATERIAL	
1	6	8'0"	7'0"		6	24	
2	6	8'0"	7'0"		6	24	
3	6	8'0"	7'0"		6	24	
4	6	8'0"	7'0"		6	24	
5	4	8'0"	7'0"		6	24	
6	1	8'0"	7'0"		6	24	
7	2	8'0"	7'0"		6	24	
8	3	8'0"	7'0"		6	24	
9	8	8'0"	7'0"		6	24	
10	7	8'0"	7'0"		6	24	
11	EXT	8'0"	7'0"		6	24	
12	EXT	8'0"	7'0"		6	24	

DOOR SCHEDULE

21	JAMB		
25	JAMB (HEAD SIM.)		
26	THRESHOLD		
27	TYPICAL CASEWORK ANCHORAGE		
29	OVERHANG @ EXIST. M.U.		
28	CABINET (PROVIDE)	1/4" x 10"	
29	JAMB		

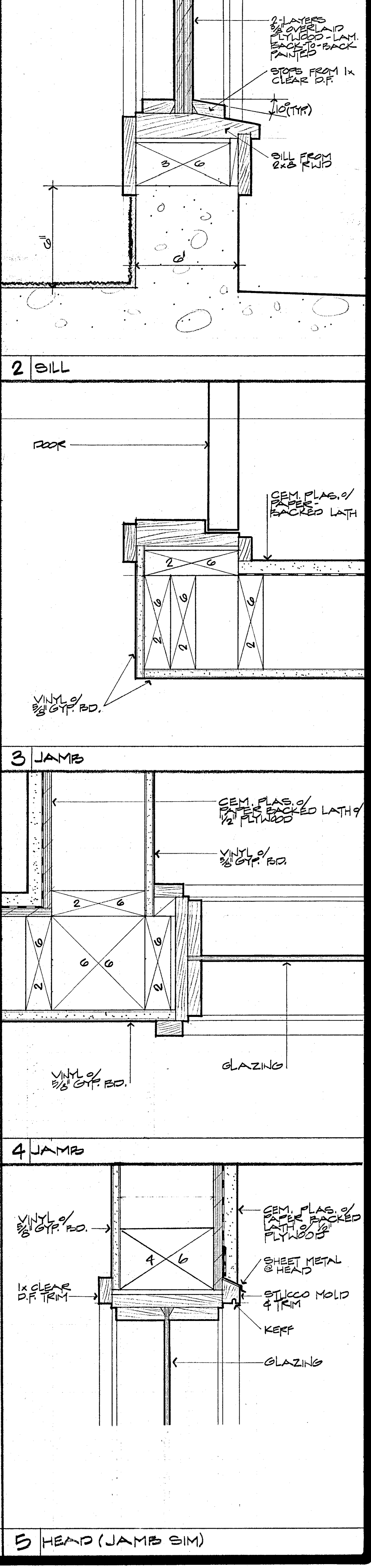
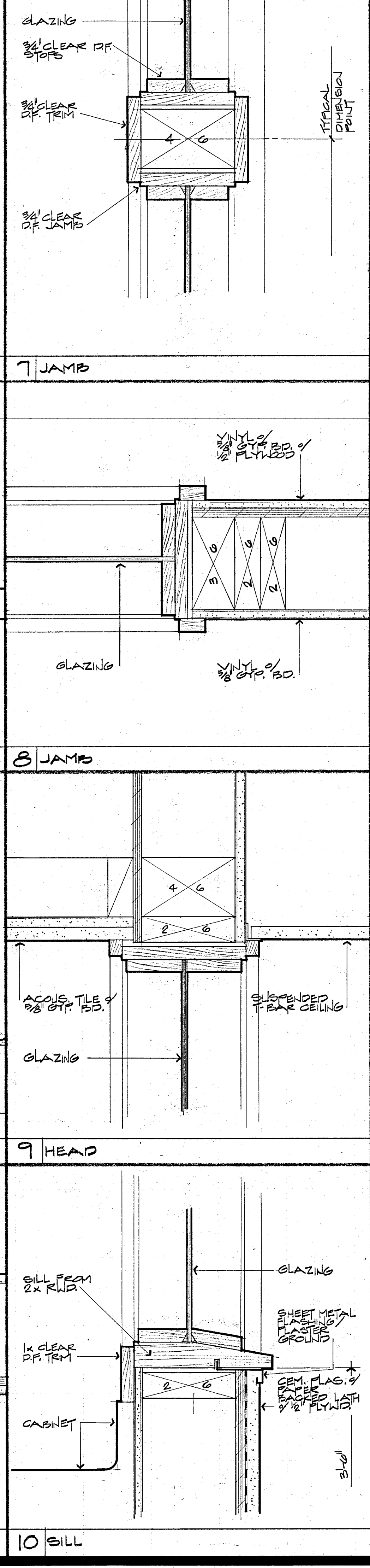
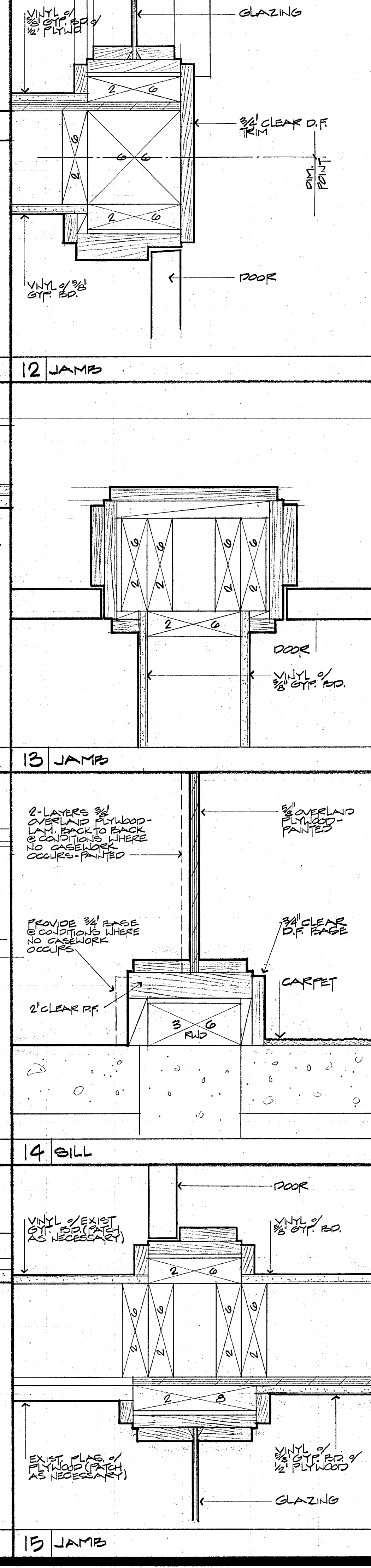
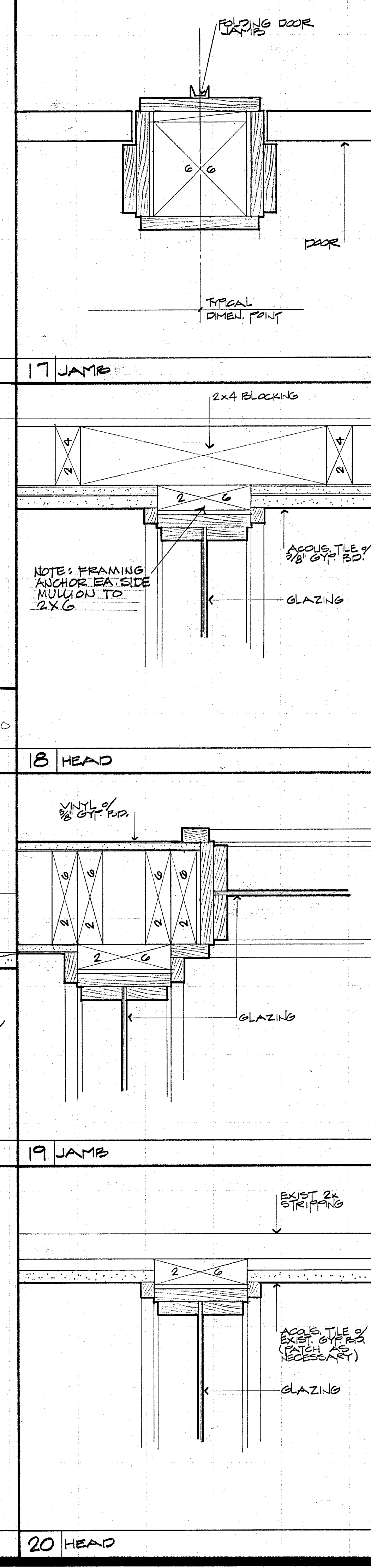
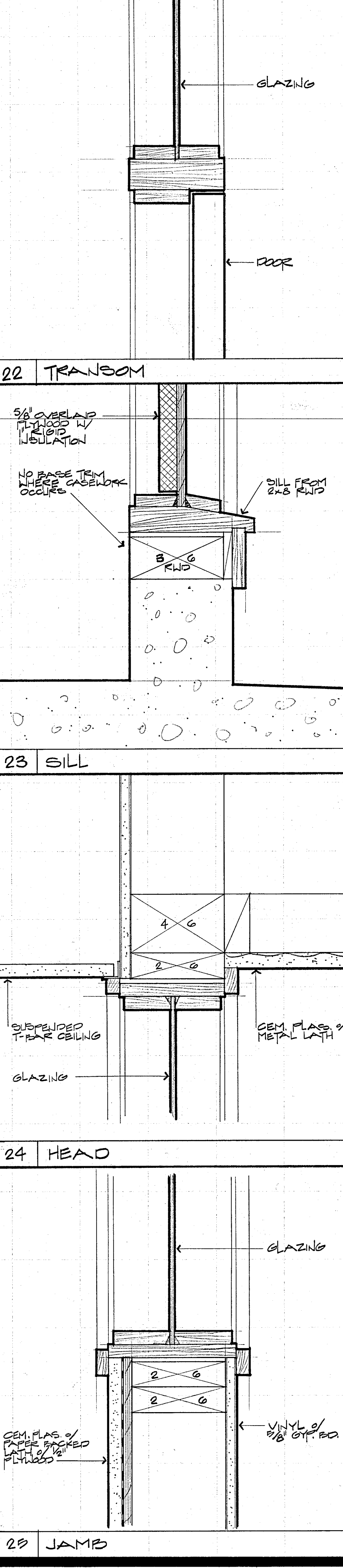
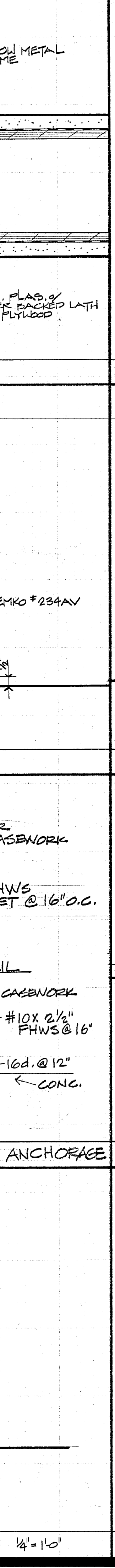

**DR. JENSEN**  
PORTER - JENSEN - HANSEN - MANZAGOL  
ARCHITECTS, A.I.A.  
445 WASHINGTON STREET, SANTA CLARA, CALIFORNIA 95050

DRAWN BY: *[Signature]*  
CHECKED BY: *[Signature]*  
DATE: 2-15-77  
PROJECT: LIBRARY ADDITION TO TOLON ELEMENTARY SCHOOL  
SANTA CLARA, CALIFORNIA

DATE: MAR 15 1979  
TIME: 4:19 P.M.  
BY: *[Signature]*  
CONSULTANT: PORTER - JENSEN - HANSEN - MANZAGOL ARCHITECTS, A.I.A.

DETAILS 3-10

LIBRARY ADDITION TO TOLON ELEMENTARY SCHOOL  
BERKESSA UNION SCHOOL DISTRICT  
SANTA CLARA, CALIFORNIA

10 OF 30 SHEETS  
1790-T



# TYPICAL DETAILS

# GENERAL NOTES

# INDEX

NOTE: WHERE POSSIBLE AND UPON APPROVAL OF THE STRUCTURAL ENGINEER AND OFFICE OF STATE ARCHITECT, PLACE FOOTING CONCRETE IN NEAT EXCAVATION WITHOUT SIDE FORMS.

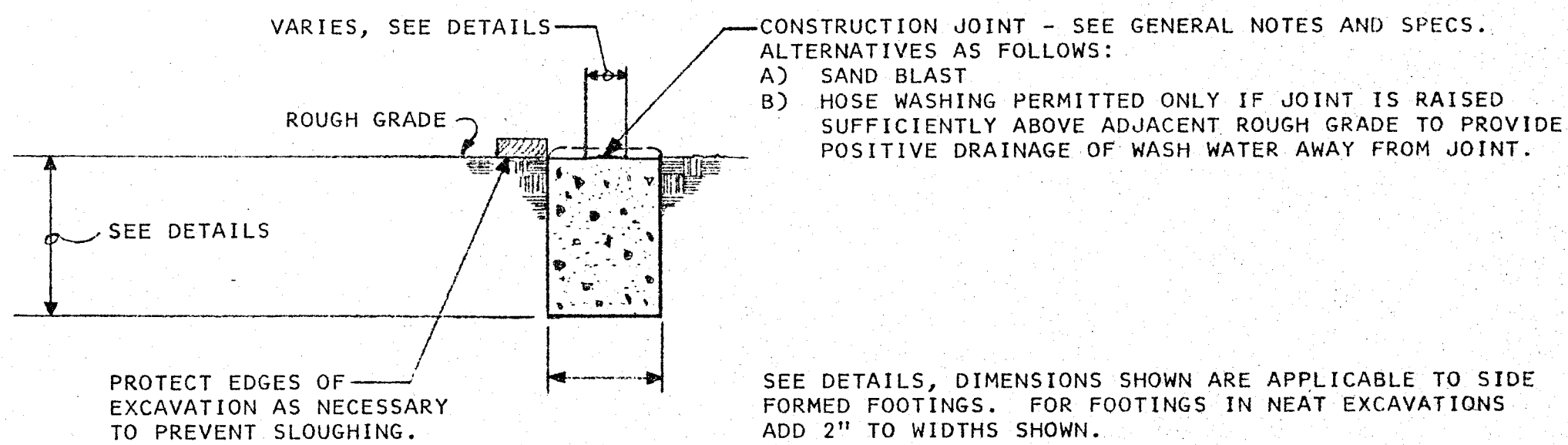

FOOTING & GRADE BEAM TRENCHES

**B1**

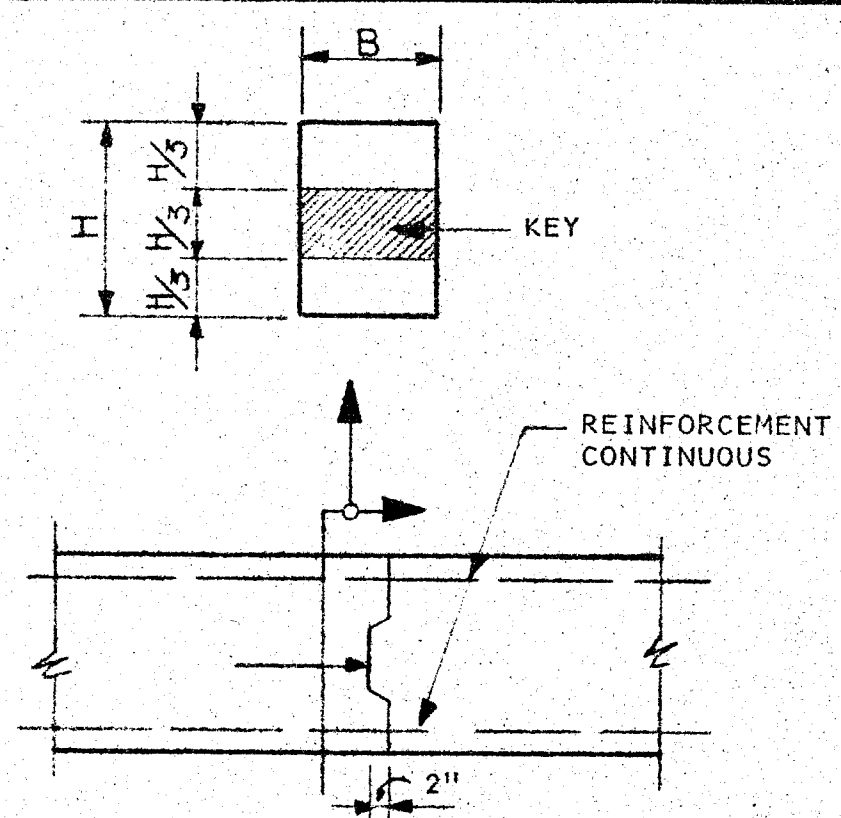

VERTICAL CONSTRUCTION JOINT AT CONTINUOUS FOOTINGS

**A1**

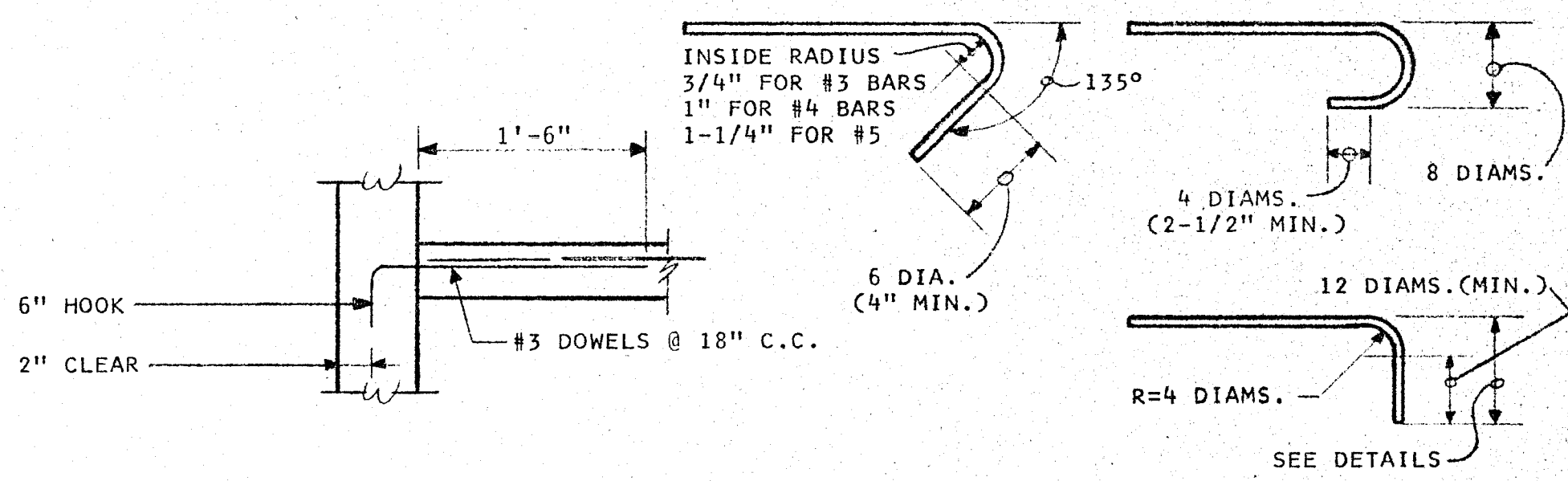

SLAB AT FOOTINGS & WALLS

**D1**

TYPICAL HOOKS

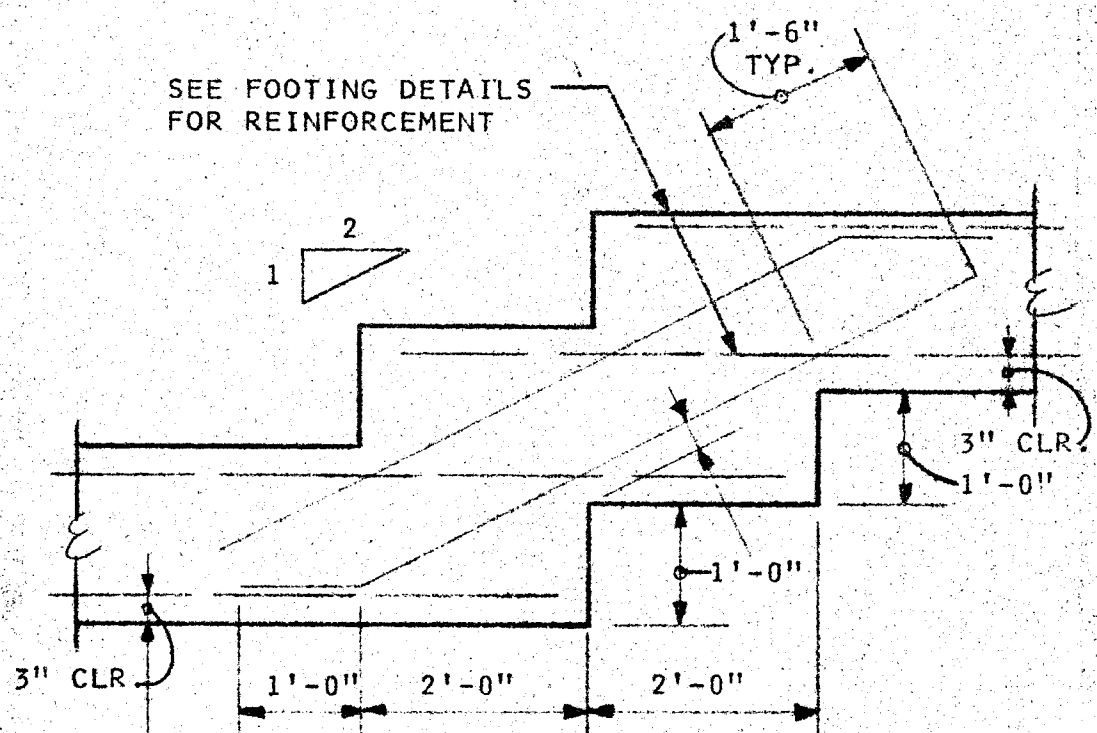

STEPS IN FOOTING

**C1**

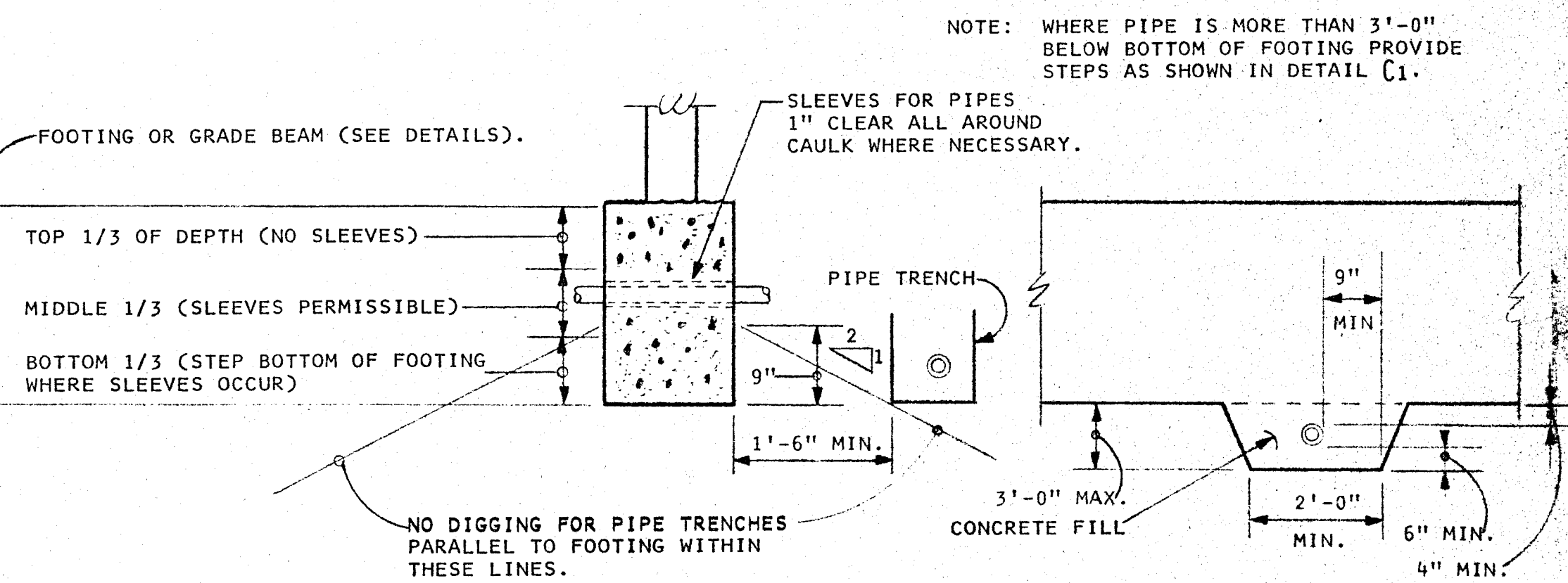

PIPE CLEARANCE AND DETAILS AT FOOTINGS AND/OR GRADE BEAMS

**F1**

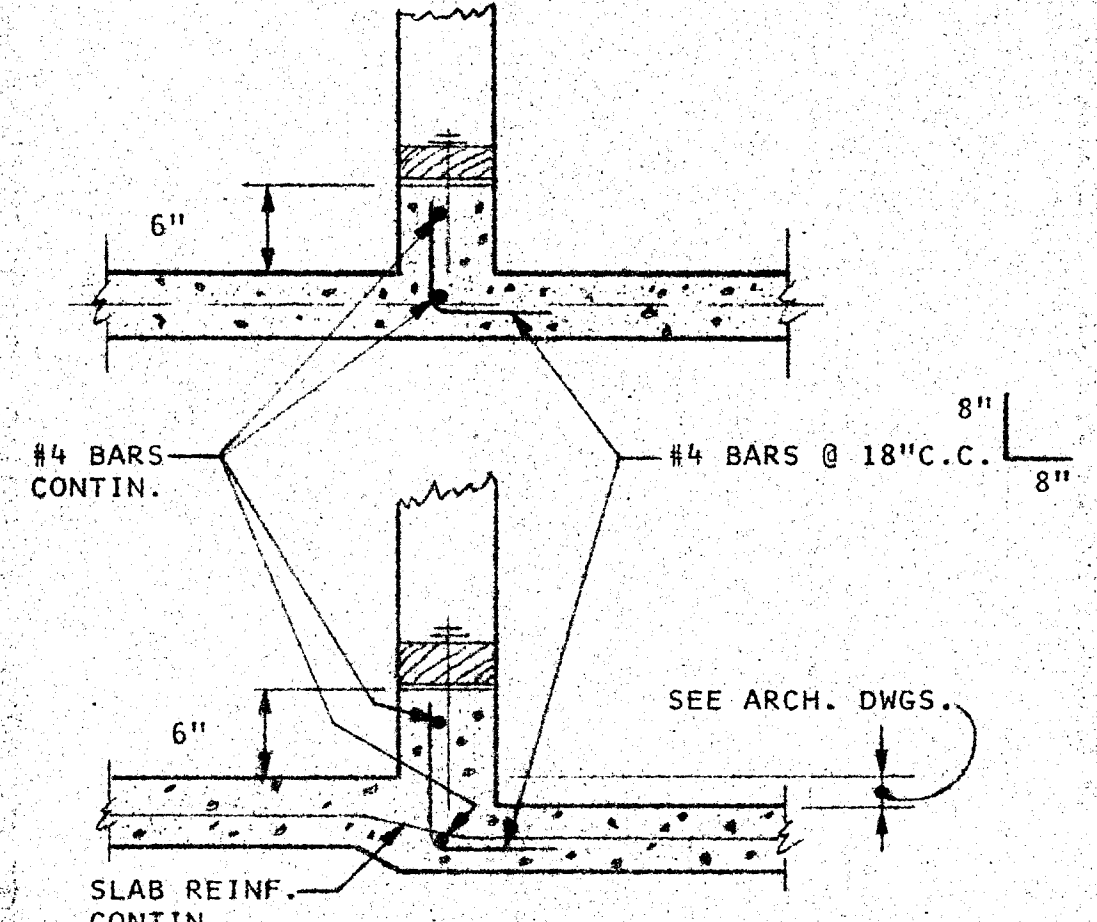

FRAMING AT OPENINGS NOT OTHERWISE SHOWN

**E1**

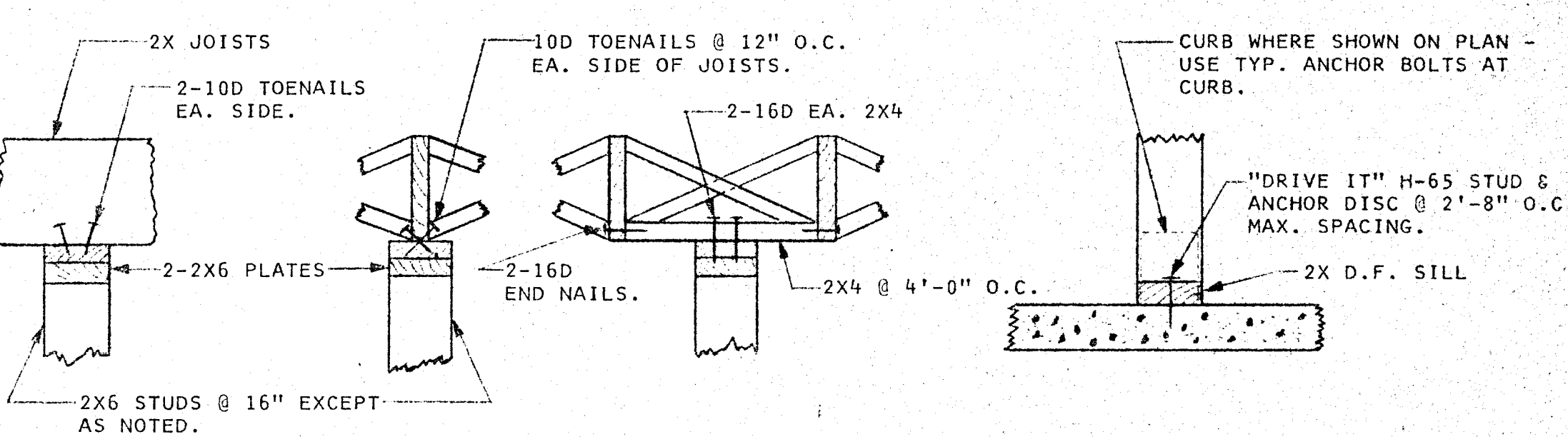

NON-STRUCTURAL PARTITIONS

**H1**

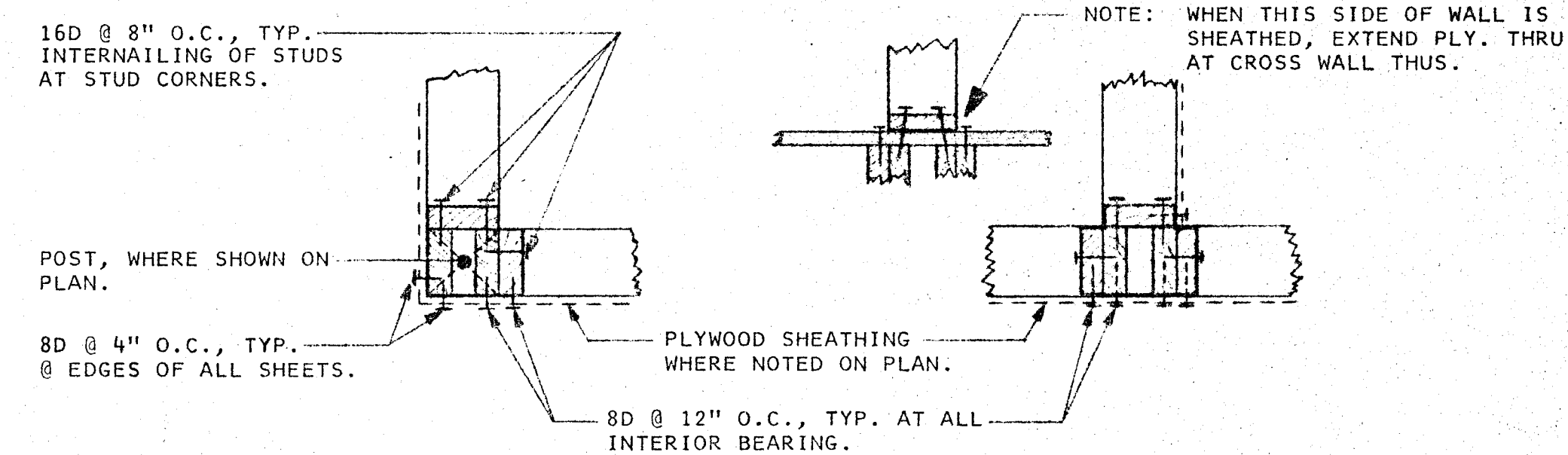

STUD CORNERS

**J1**

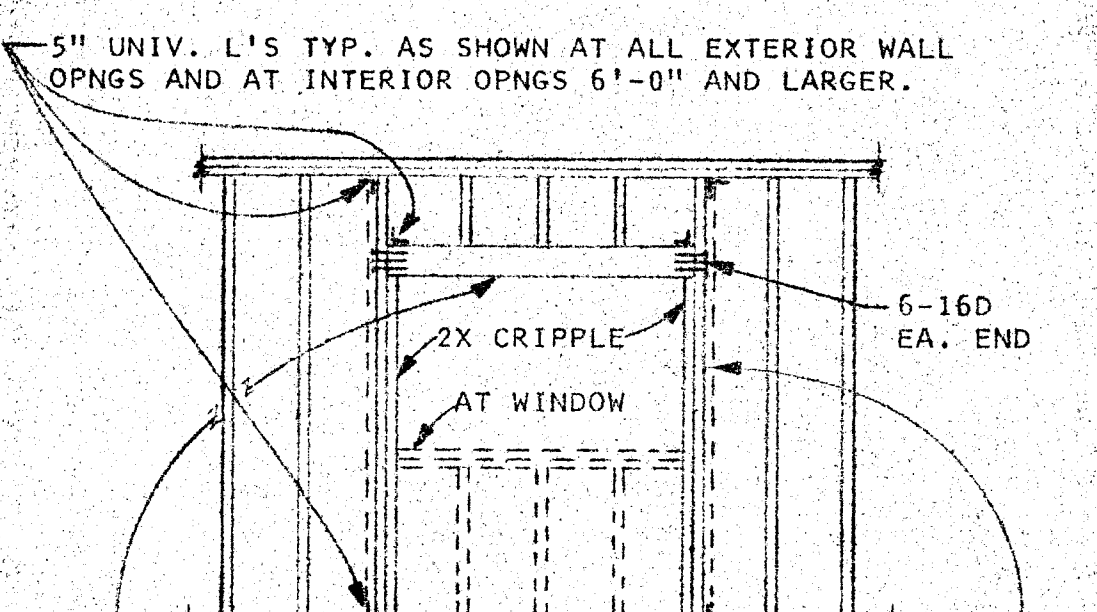

FRAMING AT OPENINGS NOT OTHERWISE SHOWN

**G1**

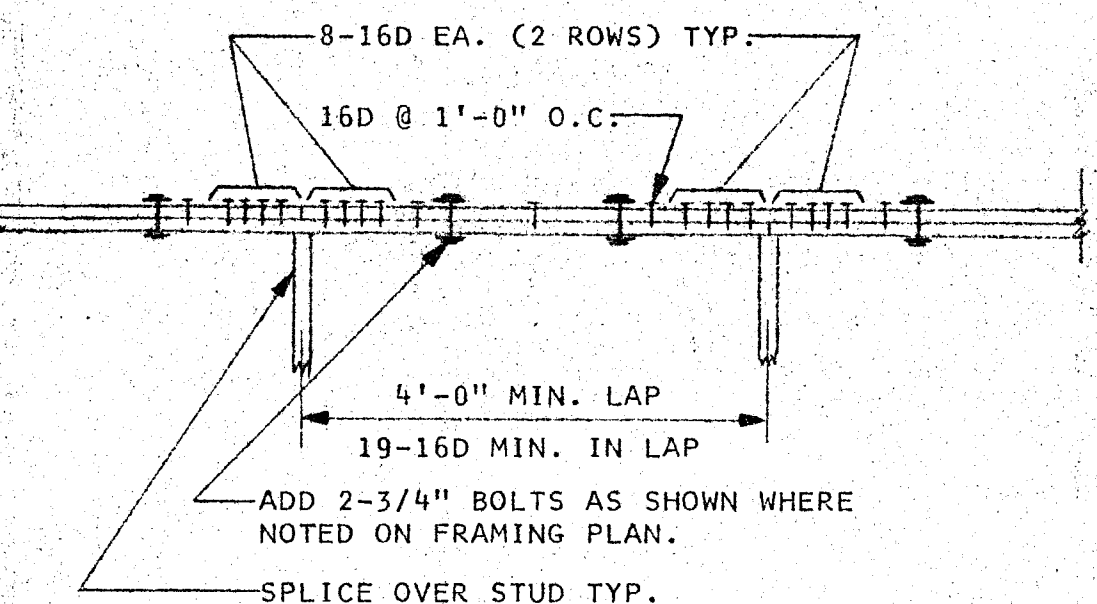

TYP. SPLICE FOR DOUBLE 2X PLATES

**I1**

APPLYING TO ALL STRUCTURAL FEATURES UNLESS OTHERWISE SHOWN OR NOTED

- CONCRETE**
  - CONCRETE STRENGTH SHALL BE NOT LESS THAN 3,000 PSI FOR FOOTINGS AND SLABS ON GROUND, 3,000 PSI FOR WALLS, BEAMS, COLUMNS AND STRUCTURAL SLABS.
  - ALL CONCRETE SHALL BE REINFORCED EXCEPT WHERE NOTED SPECIFICALLY ON DRAWINGS AS "NOT REINFORCED".
  - ALL CONCRETE CURBS ARE 6" HIGH UNLESS OTHERWISE NOTED.
- STEEL REINFORCEMENT**
  - USE A.S.T.M. A615 GRADE 40.
  - ALL REINFORCEMENT SHALL BE CONTINUOUS. LAPS AT SPLICES SHALL BE 16" FOR #3 BARS, 20" FOR #4 BARS, 24" FOR #5 BARS. WIRE BARS TOGETHER AT SPLICES OR MAINTAIN 1-1/2" CLEARANCE BETWEEN BARS.
  - STANDARD HOOKS AS DETAILED IN E1 SHALL BE USED WHENEVER HOOKS ARE CALLED FOR ON DRAWINGS.
  - REINFORCEMENT SHALL BE SECURED POSITIVELY IN PLACE BEFORE CASTING CONCRETE.
- SLAB ON GROUND**
  - SLABS ON GROUND SHALL BE 4" THICK. REINFORCE INTERIOR SLABS WITH #3 BARS AT 18" O.C. EACH WAY AT CENTER OF SLAB.
  - SUPPORT BAR REINFORCEMENT ON PRECAST CONCRETE BLOCKS SPACED AT 3'-0" EACH WAY.
  - AT JUNCTIONS OF SLABS WITH WALL PROVIDE DOWELS AS DETAILED IN E1.
- CONSTRUCTION JOINTS**
  - ROUGHEN SURFACES TO EXPOSE CLEAN AGGREGATE AT ALL JOINTS.
  - SEE DETAIL C1 REGARDING HORIZONTAL FOOTING CONSTRUCTION JOINTS.
  - KEY VERTICAL JOINTS, SEE DETAIL D1.
- STRUCTURAL STEEL**
  - STRUCTURAL STEEL, EXCLUDING TUBULAR SECTIONS, SHALL CONFORM TO A.S.T.M. A36. TUBULAR SECTIONS SHALL CONFORM TO A.S.T.M. A500 OR A501.
  - ALL GROOVE WELDS SHALL BE COMPLETE PENETRATION WELDS WITH DETAILS SUCH THAT WELD IS ACCEPTABLE WITHOUT WELDING PROCEDURE QUALIFICATION UNDER A.W.S. CODE AND AISC SECTION 1.17.2. SEE SPECIFICATIONS REGARDING INSPECTION.
  - BOLTED CONNECTIONS SHALL BE MADE WITH UNFINISHED BOLTS A.S.T.M. A307. THREADS SHALL BE EXCLUDED FROM SHEAR PLANES.
  - PAINT, SEE SPECIFICATIONS.
- GLUED LAMINATED BEAMS**
  - ALL STRUCTURAL GLUED LAMINATED LUMBER SHALL BE FABRICATED AND INSPECTED IN ACCORDANCE WITH TITLE 21 - 2511.
  - USE COMBINATION 24F FOR ALL MEMBERS.
  - ADHESIVE FOR ALL MEMBERS SHALL BE EXTERIOR TYPE, AS PER MILITARY SPECIFICATION MIL-A3978.
- SOIL CONDITIONS**
  - FOOTINGS SHALL BEAR ON NEW ENGINEERED FILL, WITH 2'-6" THICKNESS OF FILL BELOW FOOTINGS.
  - SEE ARCHITECTURAL DRAWINGS AND SPECIFICATIONS FOR GENERAL GRADING REQUIREMENTS.
  - SOIL BEARING PRESSURES DO NOT EXCEED 1,500 P.S.F. DEAD LOAD OR 2,000 P.S.F. DEAD LOAD PLUS LIVE LOAD. (BASED ON GRUBBARD, JACOBS & JONES REPORT, 1/15/65)

- CARPENTRY NOTES**
  - FRAMING**

SILLS ON CONCRETE SHALL BE PRESSURE TREATED D.F. THEY SHALL BE ANCHORED WITH 5/8" X 1'-0" BOLTS AT 4'-0" MAX. AND 9" FROM ENDS OF EACH PIECE WITH AT LEAST TWO BOLTS IN EACH PIECE. WHERE NOTCHES FOR PIPES EXCEED 1/3 OF WIDTH OF THE SILL, PLACE A BOLT WITHIN 9" OF EACH END OF NOTCH. SILLS SHALL BE BEDDED IN 1:3 CEMENT MORTAR 1/2" THICK.

STUD WALLS AND PARTITIONS SHALL BE FRAMED AS DETAILED. PARTITIONS NOT OTHERWISE SHOWN SHALL BE 2X6 STUDS AT 16" O.C. PROVIDE 2" BRIDGING SO THE UNBRACED LENGTH OF STUDS SHALL NOT EXCEED 8'-0". AT SHEATHED WALLS CENTER 2" BLOCKING BEHIND ALL HORIZONTAL PLYWOOD JOINTS EXCEPT AS OTHERWISE SHOWN. LAP AND INTERNAL DOUBLE TOP PLATES, SEE D1.

JOISTS, EXCEPT AS OTHERWISE SHOWN, SHALL HAVE FULL BEARING AND 2" BLOCKING AT SUPPORTS. PROVIDE CROSS BRIDGING AT 10'-0" MAX. O.C. (OMIT CROSS BRIDGING FOR JOISTS 8" AND UNDER IN DEPTH).

BOLT HOLES IN WOOD SHALL BE 1/32" LARGER THAN BOLT DIAMETER. PROVIDE WASHERS UNDER HEAD AND NUT WHERE BEARING IS AGAINST WOOD. USE STANDARD MALLEABLE IRON WASHERS UNDER NUTS OF ALL SILL BOLTS, STEEL PLATE WASHERS ELSEWHERE.

1/2" BOLTS - 2" SQUARE X 1/4" STEEL WASHER.  
 5/8" BOLTS - 2-3/4" DIAM. X 5/16" M.I. WASHER, 2-1/2" SQ. X 1/4" STEEL PLATE WASHER.  
 3/4" BOLTS - 3" DIAM. X 7/16" M.I. WASHER, 3" SQ. X 5/16" STEEL PLATE WASHER.

LAG SCREWS SHALL BE INSTALLED WITH WRENCH, NOT DRIVEN WITH HAMMER. PROVIDE LEAD HOLES PREBORED AS FOLLOWS: FOR SHANK, SAME DIAMETER AND DEPTH AS SHANK; FOR THREADED PORTION 75% SHANK DIAMETER TO FULL PENETRATION OF POINT.
  - SHEATHING: SEE K1**
  - NAILING SCHEDULE**

ALL WOOD MEMBERS SHALL BE CONNECTED WITH NAILING LISTED, UNLESS A GREATER NUMBER OF NAILS IS CALLED FOR ELSEWHERE ON THE DRAWINGS. ALL NAILS SHALL BE COMMON WIRE NAILS. WHERE THE NAILING SPECIFIED TENDS TO SPLIT THE WOOD, HOLES FOR NAILS SHALL BE PRE-DRILLED. SPLIT MEMBERS SHALL BE TAKEN OUT AND REPLACED.

JOIST TO BEARING----- 2-10D TOENAILS EA. SIDE.  
 JOIST TO SIDE OF STUD----- 3-16D FOR 8", PLUS 1-16D PER 2" ADDITIONAL DEPTH.  
 JOIST TO PARALLEL PLATES----- 10D TOENAILS AT 1'-0" EA. SIDE.  
 JOIST TO JOIST AT LAPS----- 4-16D.

DOUBLE TOP PLATES (2X PLATES)  
 PLATE TO PLATE----- 16D AT 1'-0" O.C.  
 LOWER PLATE TO STUD----- 2-16D TO 2X4 STUDS, 3-16D TO 2X6 AND 2X8 STUDS.

MULTIPLE STUDS----- 16D AT 8" O.C. EA. PAIR.  
 STUDS TO BEARING, 2X4 AND SMALLER----- 2-10D TOENAILS EA. SIDE.  
 STUDS TO BEARING, 2X6----- 3-10D TOENAILS EA. SIDE.

CEILING STRIPPING (1" NOMINAL)----- 2-8D COMMON NAILS EA. JOIST, 1 STR. AND 1 SLANTED.  
 CEILING STRIPPING (2" NOMINAL)----- 2-16D COMMON NAILS EA. JOIST, 1 STR. AND 1 SLANTED.

BLOCKING TO JOISTS----- 2-10D TOENAILS EA. SIDE EA. END.  
 BLOCKING TO BEARING (PLATES, BEAMS, ETC.)----- 2-10D TOENAILS EA. SIDE.  
 BLOCKING TO STUDS----- 2-10D TOENAILS EA. SIDE EA. END.

DOUBLE JOIST (8" DEPTH OR LESS)----- INTERNAL 16D AT 1'-0" O.C. (STAGGER)  
 DOUBLE JOIST (GREATER THAN 8" DEPTH)----- NAIL AS ABOVE AND ALSO BOLT WITH 1/2" BOLTS AT 2'-0" O.C. (STAGGER)

2X3 HERRINGBONE CROSSBRIDGING----- 2-8D EA. END EA. PIECE, NAIL LOWER ENDS AFTER ROOF IS ON.
  - METAL FRAMING CONNECTORS:**

THESE DEVICES SHALL BE AS MANUFACTURED BY SIMPSON, UNIVERSAL ANCHORS OR APPROVED EQUAL OF LIKE DIMENSIONS, GAUGE AND NUMBER OF NAILS. HOLES ARE PREPUNCHED. ANGLES SHALL BE PLACED WITH SHORT LEG ALONG CONTINUOUS MEMBER AT JOINT. USE NAILS FURNISHED WITH CONNECTOR. INSPECTOR'S COPY OF SPECIAL CONNECTION DETAILS TO BE OBTAINED FROM ENGINEER.

AS BUILT FOR REFERENCE ONLY

SH. No.	DESCRIPTION
51	GENERAL NOTES & TYPICAL DETAILS
52	FOUNDATION & ROOF FRAMING PLANS, FND. DETAILS
53	STRUCTURAL DETAILS

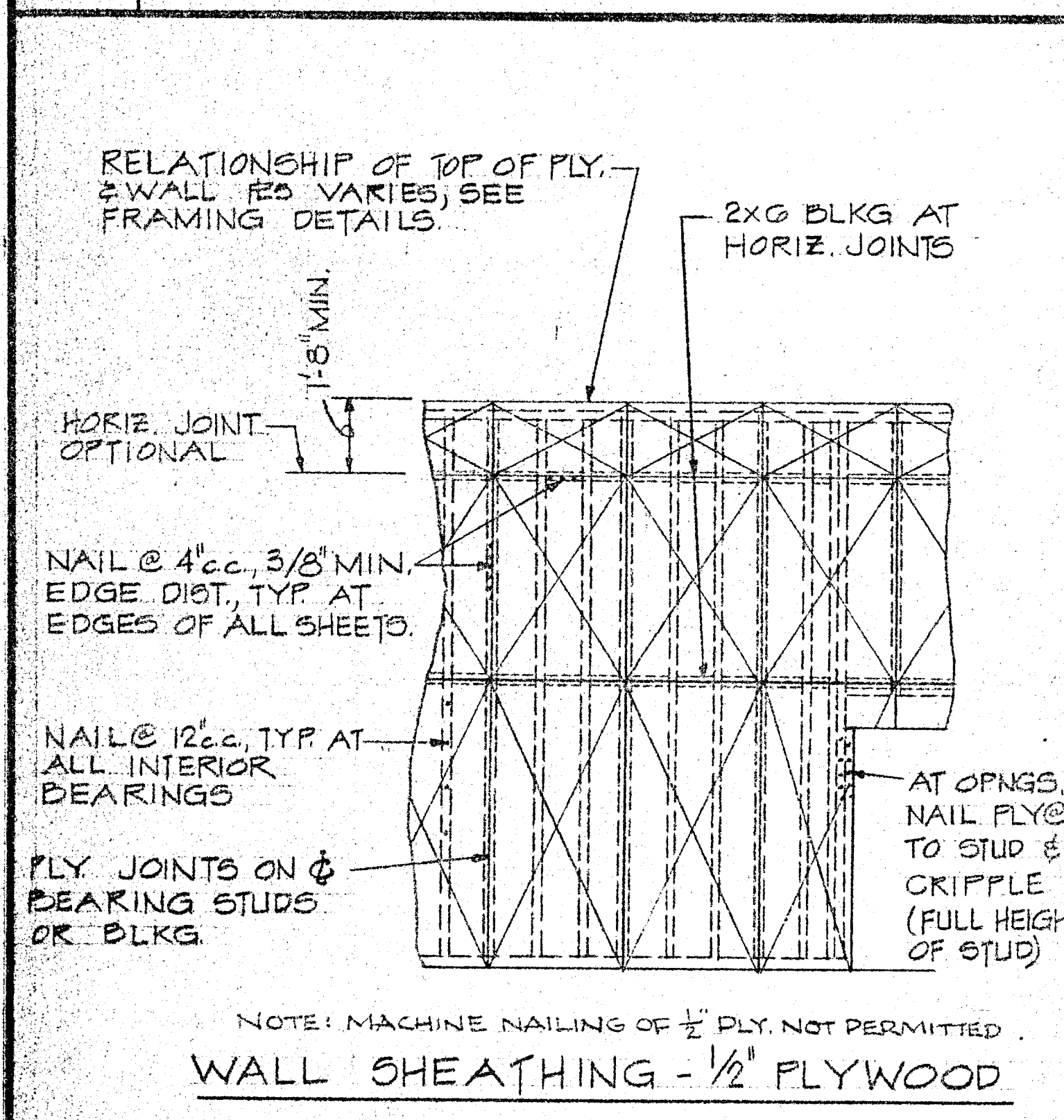

WALL SHEATHING - 1/2" PLYWOOD

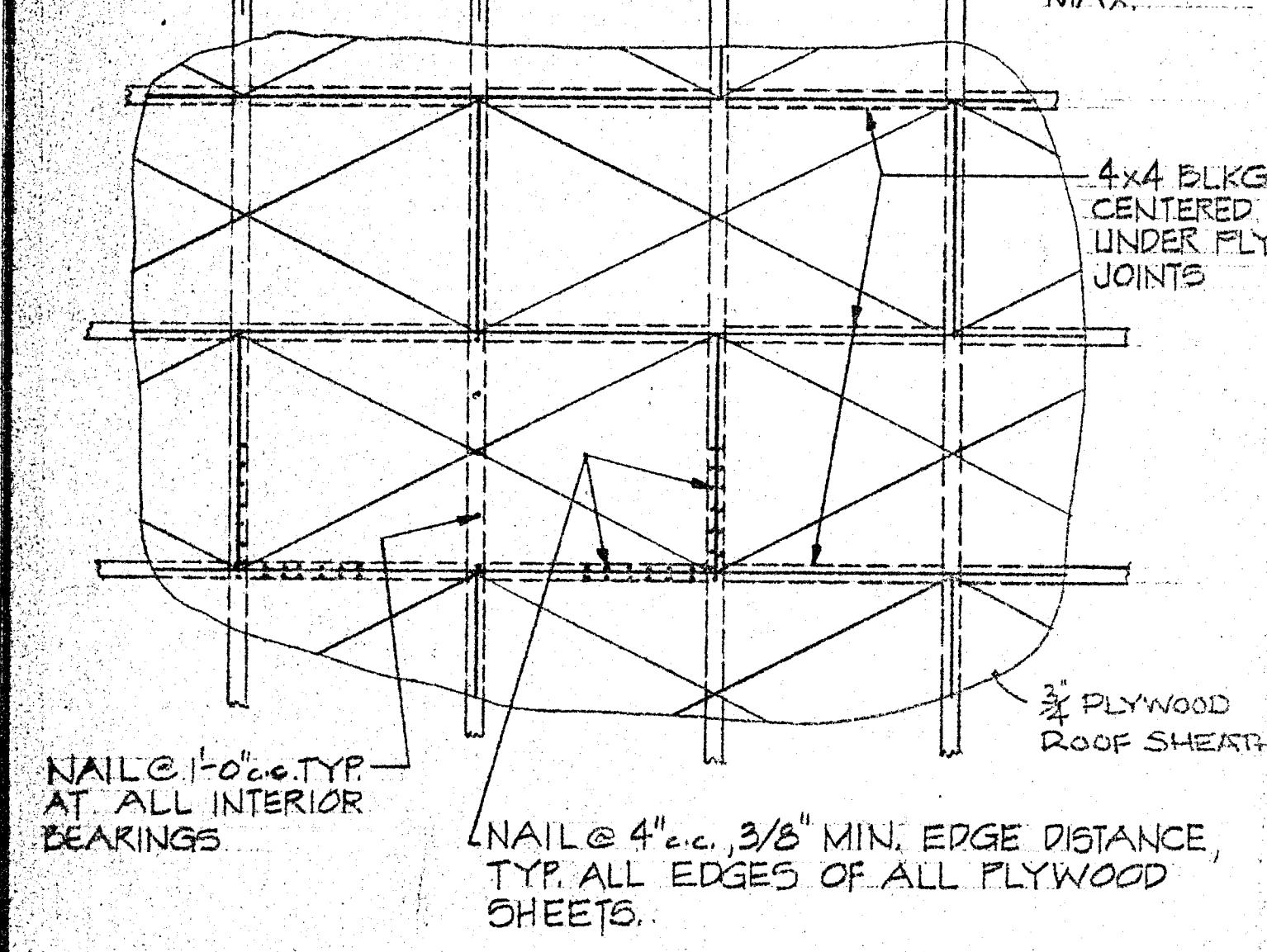

- NOTES:**
- ALL PLYWOOD SHEATHING SHALL BE PS1-74 STRUCTURAL I GRADE W/EXTERIOR GLUE & SHALL BEAR THE GRADE MARK OF AN APPROVED TESTING AGENCY APA, TECO, OR PTL. PANEL ID. INDEX 48-24 FOR 3/4" THICK.
  - ALL NAILS SHALL BE 8d COMMON FOR 1/2" PLYWOOD & 10d COMMON FOR 3/4" PLYWOOD
  - NO PANEL LESS THAN 12" WIDE SHALL BE USED

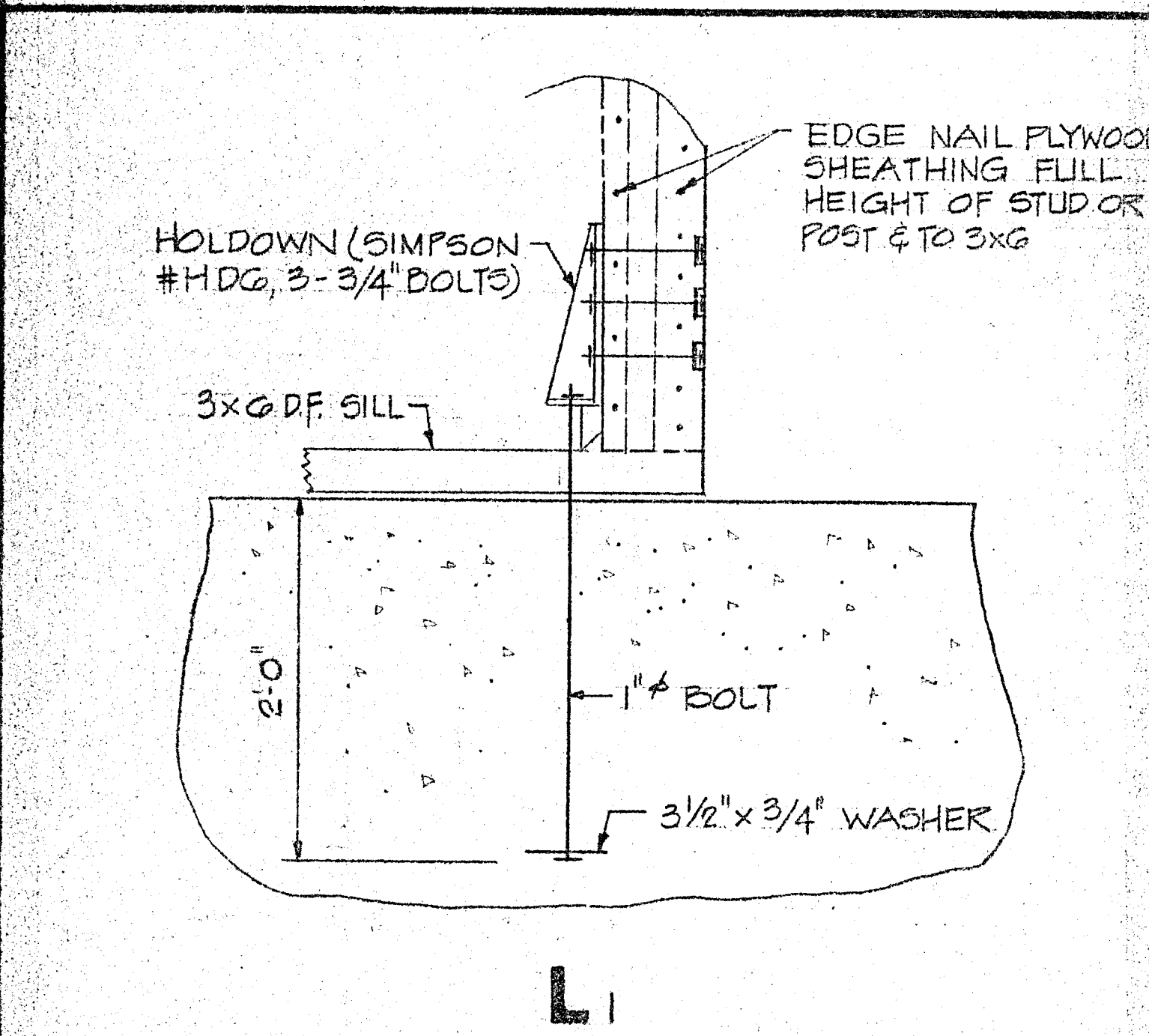

**K1**

ARCHITECTS A.I.A.  
 PORTER · JENSEN · HANSEN · MANZAGOL  
 1515 J STREET, SUITE 200, OAKLAND, CALIFORNIA 94612  
 PHONE: 415-763-1515  
 FAX: 415-763-1516  
 M.P.R. 5. 1975  
 CONSULTANT  
 CHARLES F. BIRNBAUMER  
 STRUCTURAL ENGINEER  
 1909 14TH AVENUE, SUITE 201  
 SAN FRANCISCO, CALIFORNIA 94133  
 GENERAL NOTES, TYPICAL DETAILS  
 LIBRARY ADDITION TO TOTOY ELEMENTARY SCHOOL  
 1985/86/87 Uvalde School District  
 SAN JOSE, CALIFORNIA  
 0-SHEETS  
 233-PLANNED  
 11/2007



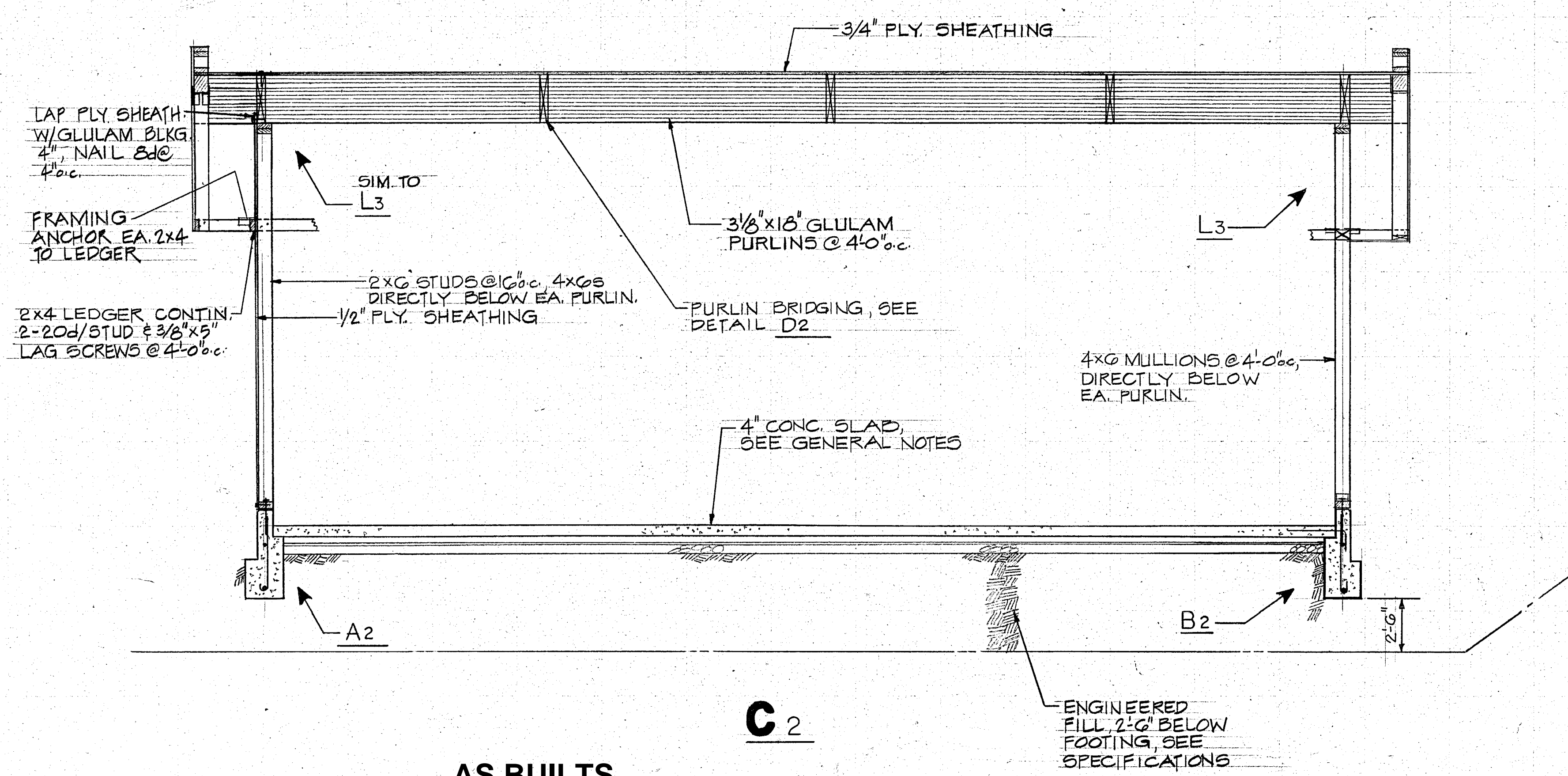

**AS BUILT  
FOR REFERENCE ONLY**

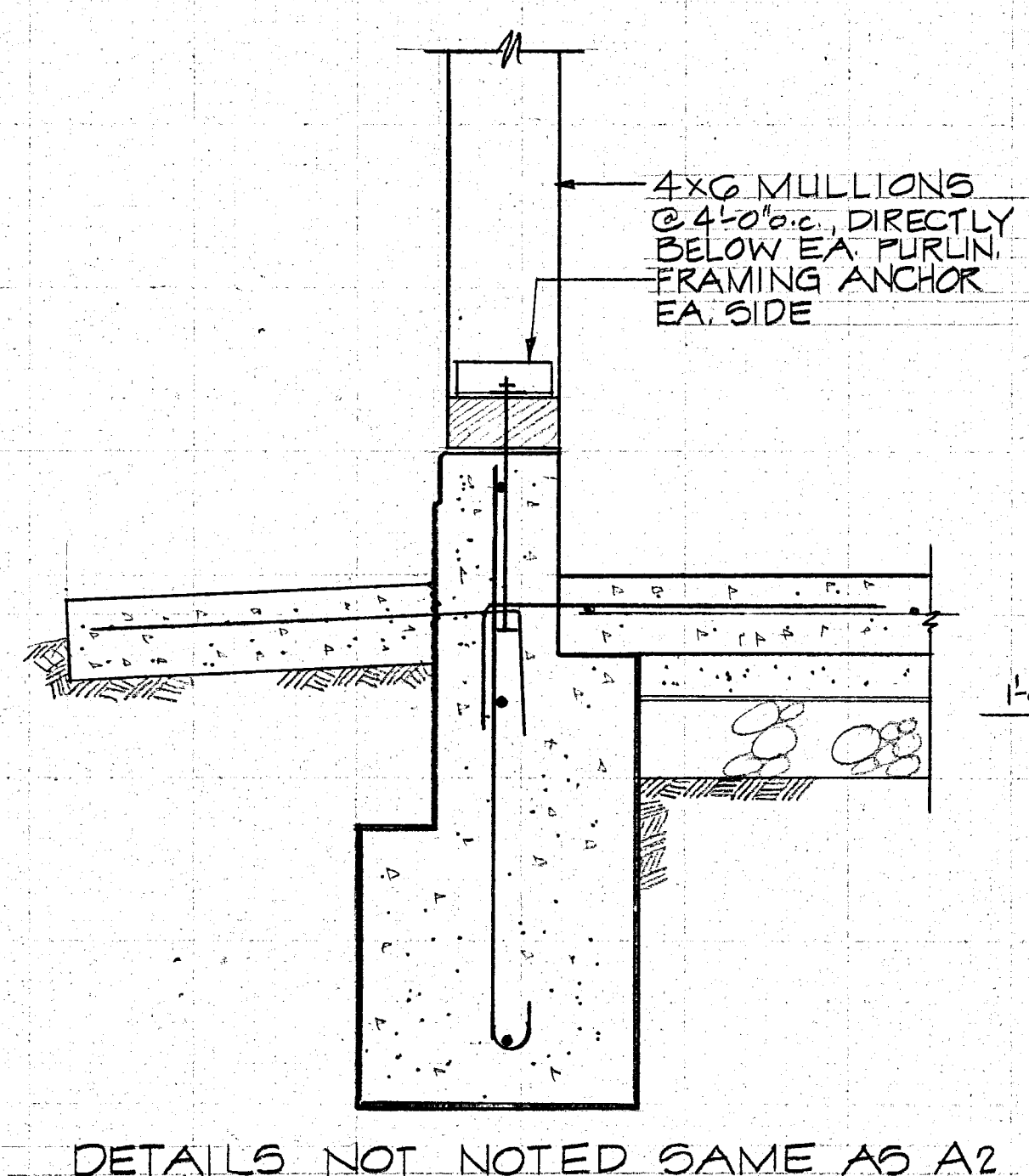

**B2**

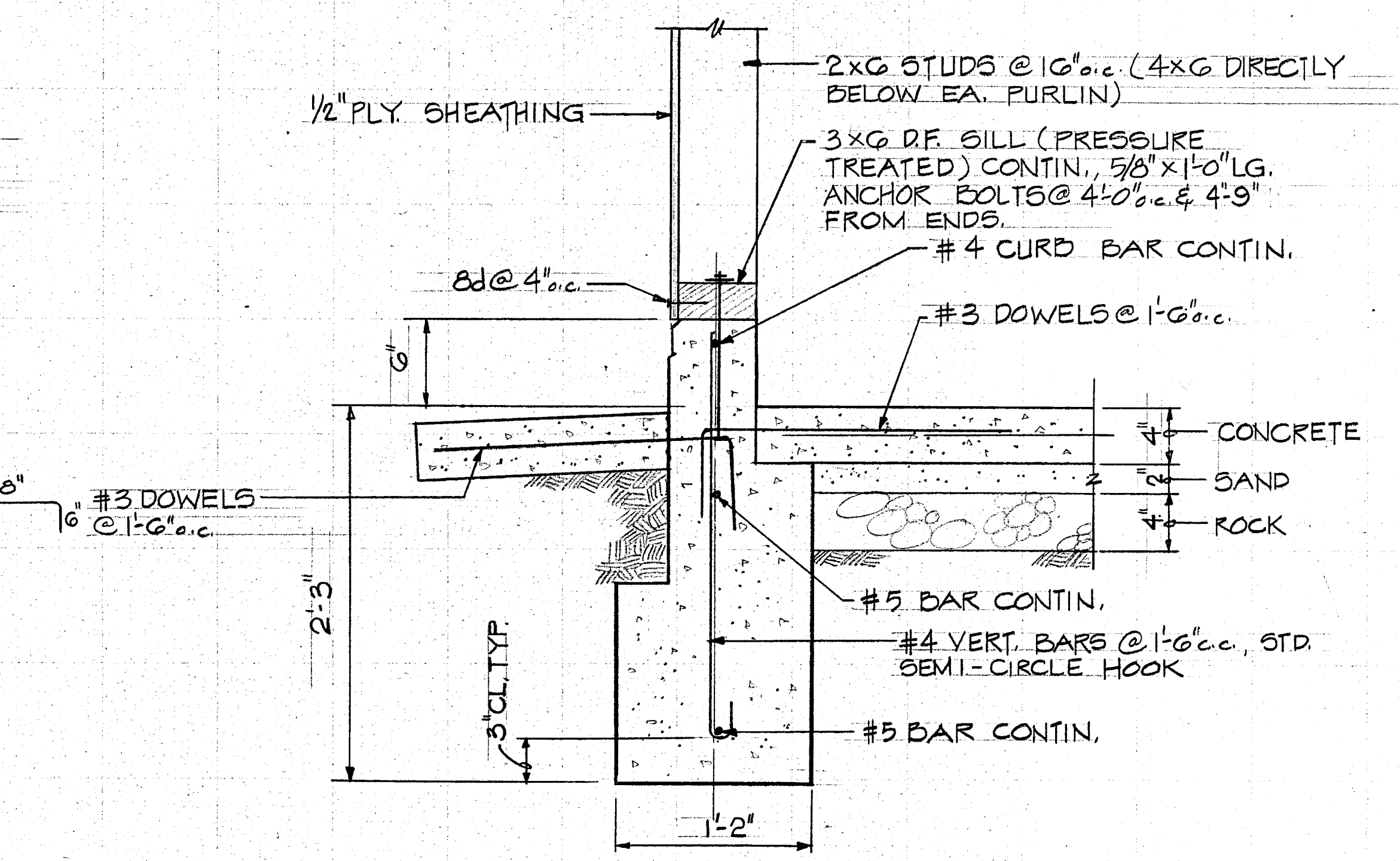

**A2**

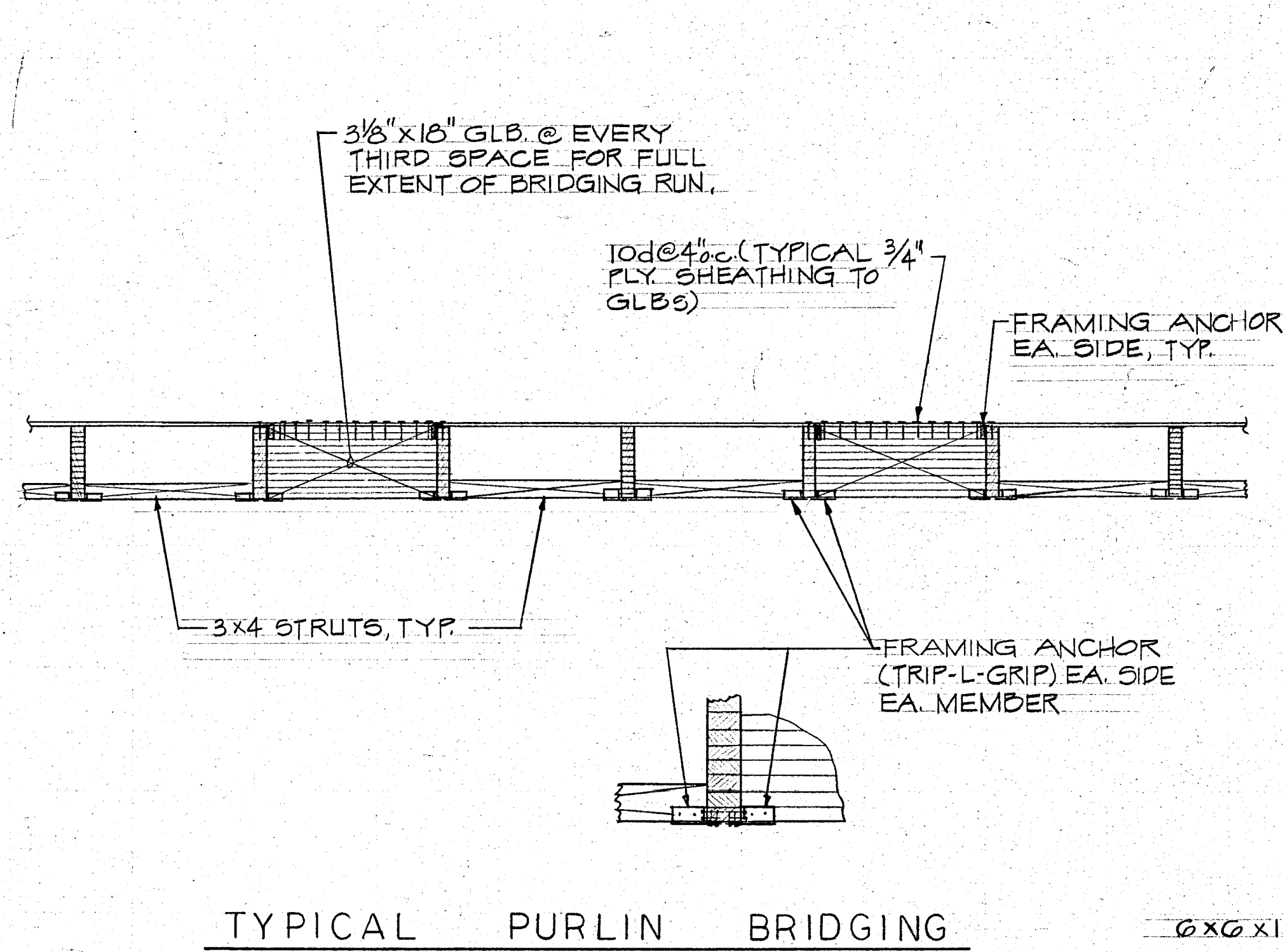

**D2**

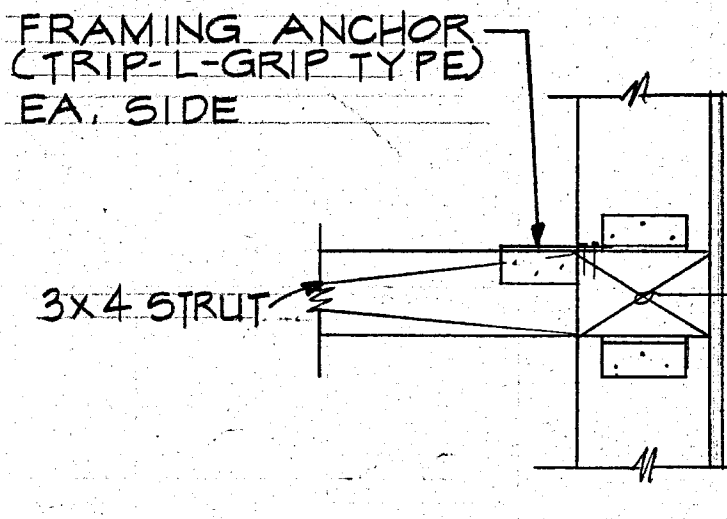

**E2**

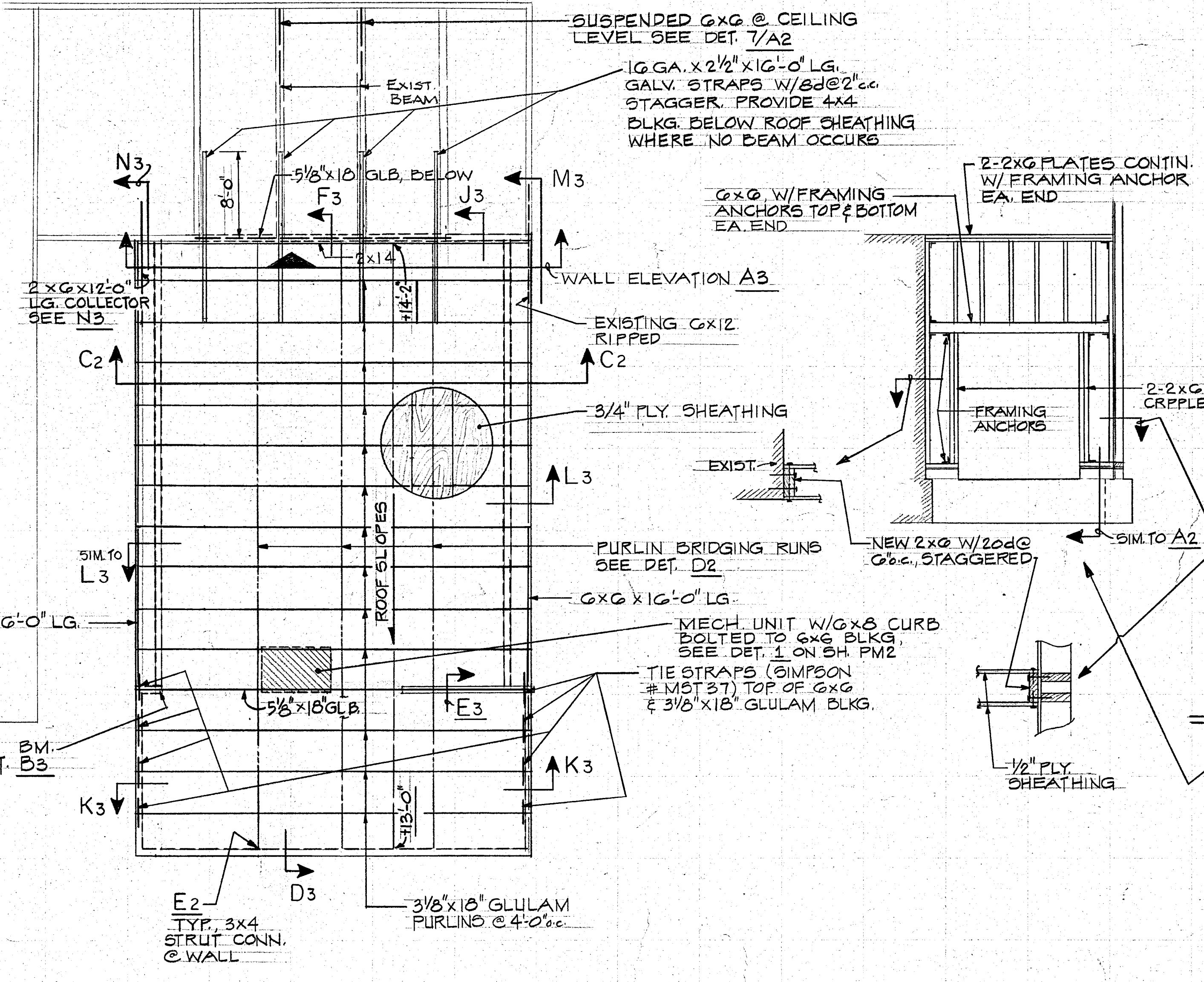

**ROOF FRAMING PLAN**  
SCALE: 1/8"=1'-0"

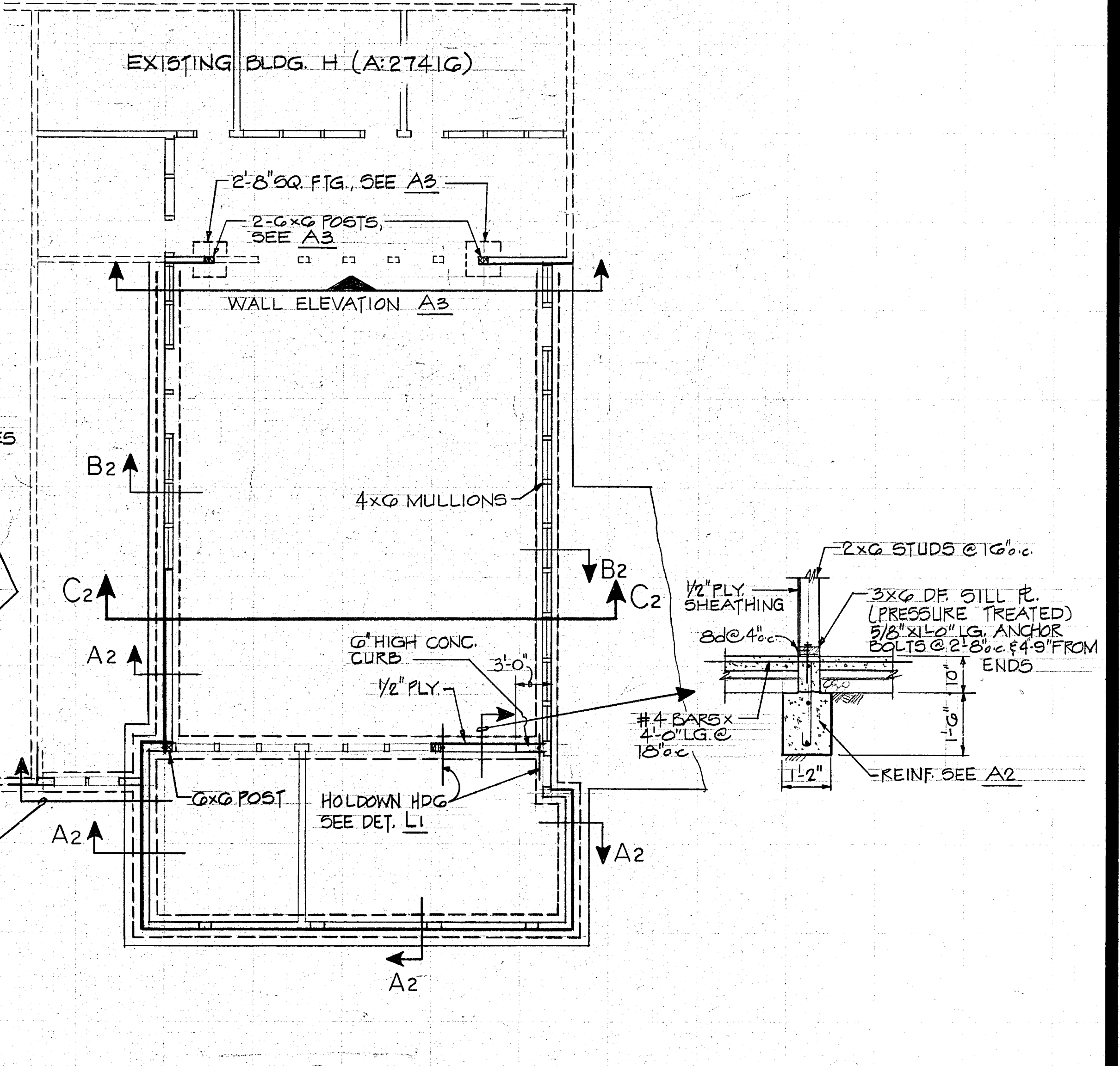

**FOUNDATION PLAN** REF. NORTH  
SCALE: 1/8"=1'-0"

L SEE GENERAL NOTES & TYPICAL DETAILS SHEET 01.  
Z FOR CRICKETS, CANTS, DRAINS, OPENINGS NOT SHOWN, ETC., SEE ARCHITECTURAL AND/OR PLUMBING-MECHANICAL DRAWINGS.



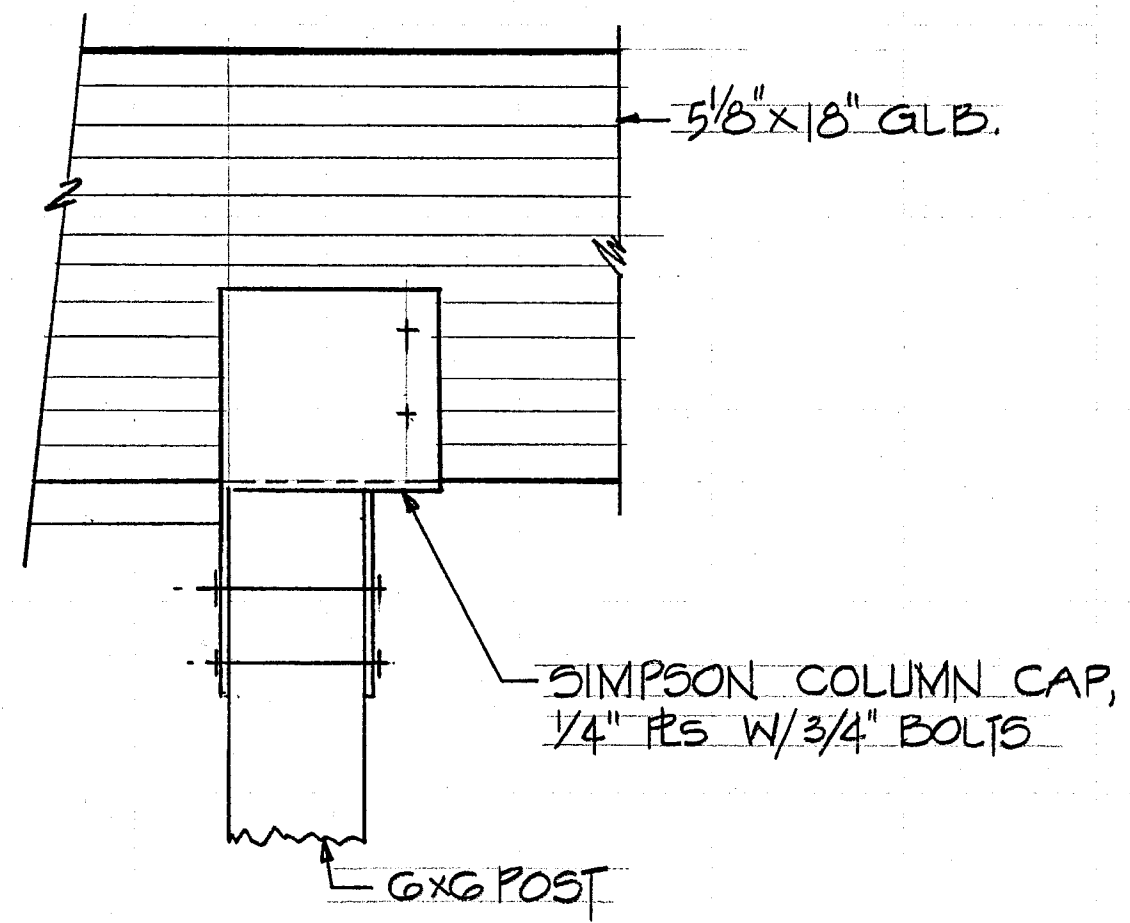

**B3**

AS BUILT FOR REFERENCE ONLY

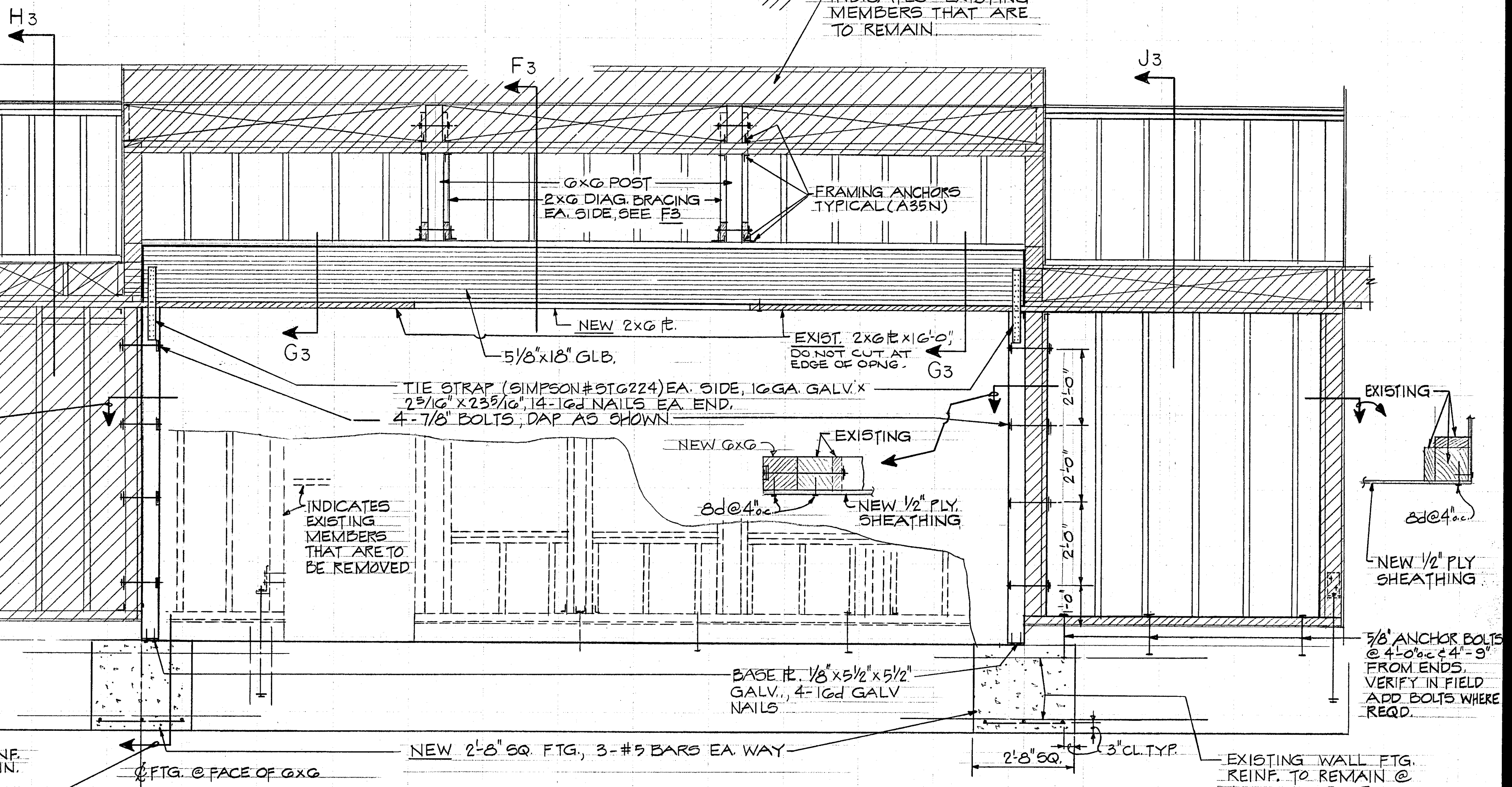
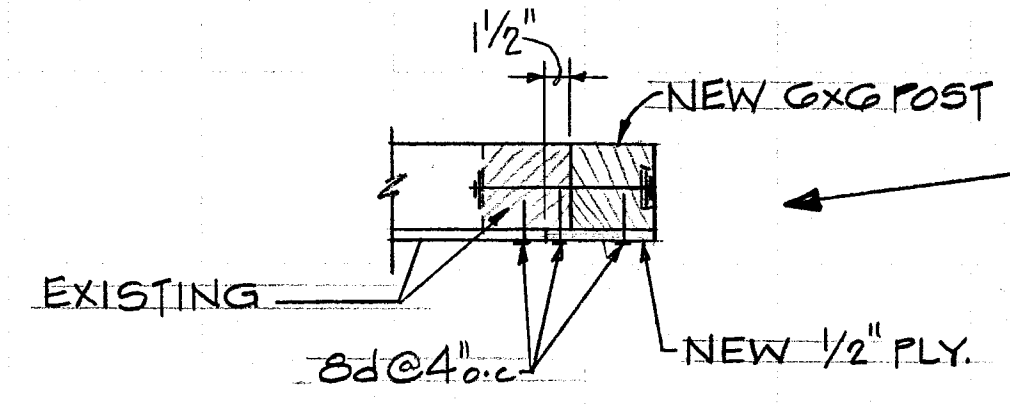

**A3 ELEVATION - EXISTING WALL**

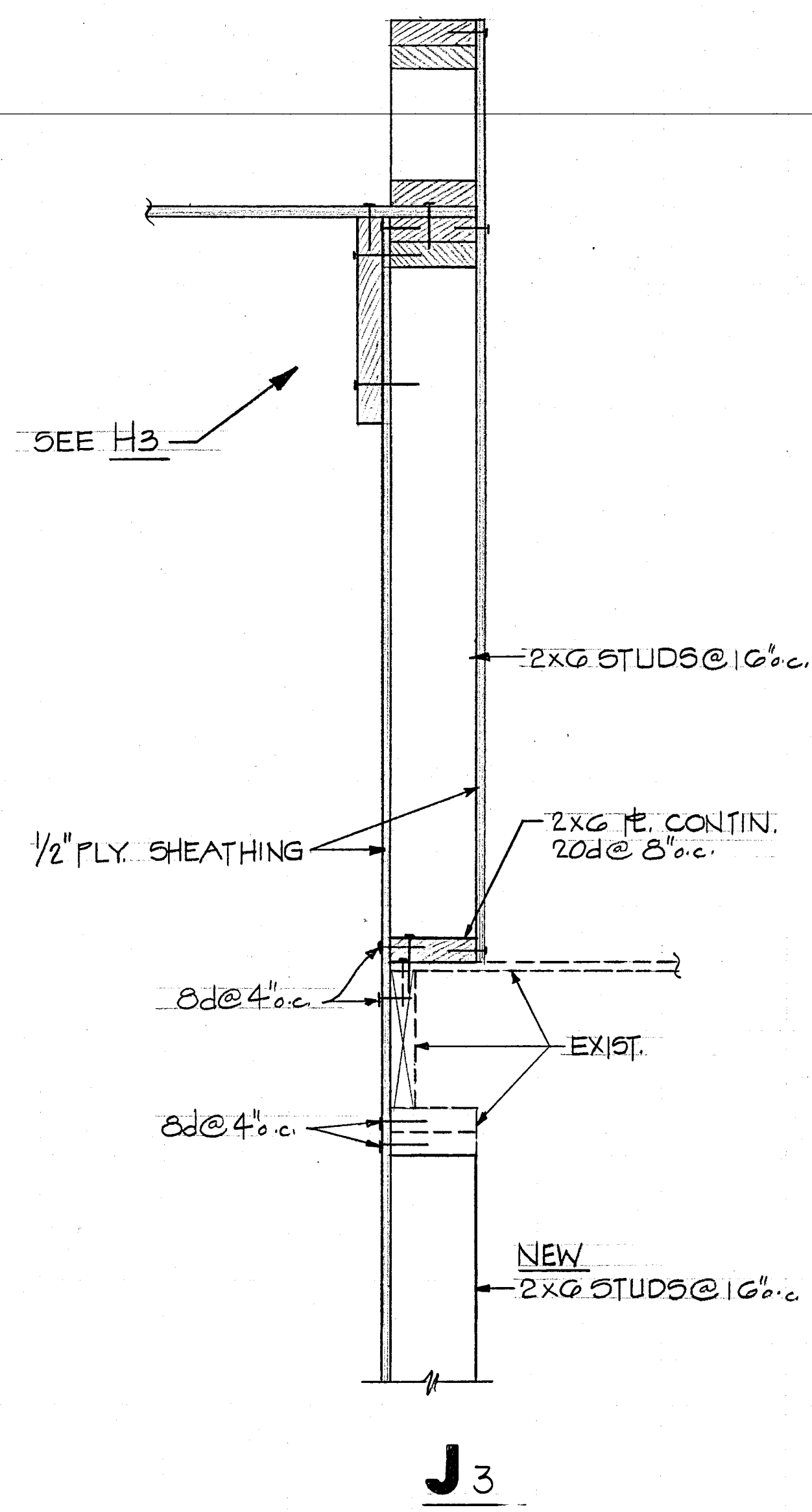

**J3**

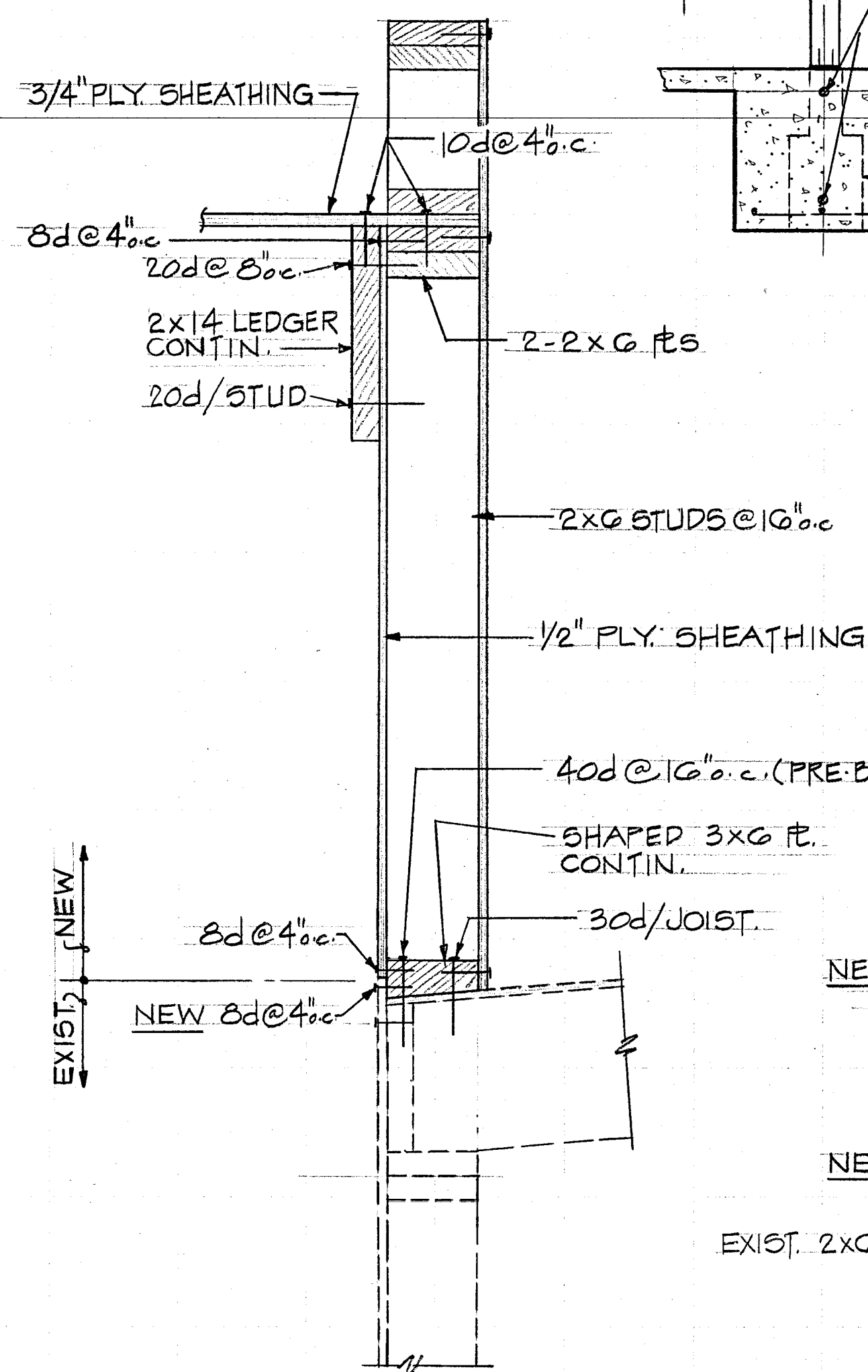

**H3**

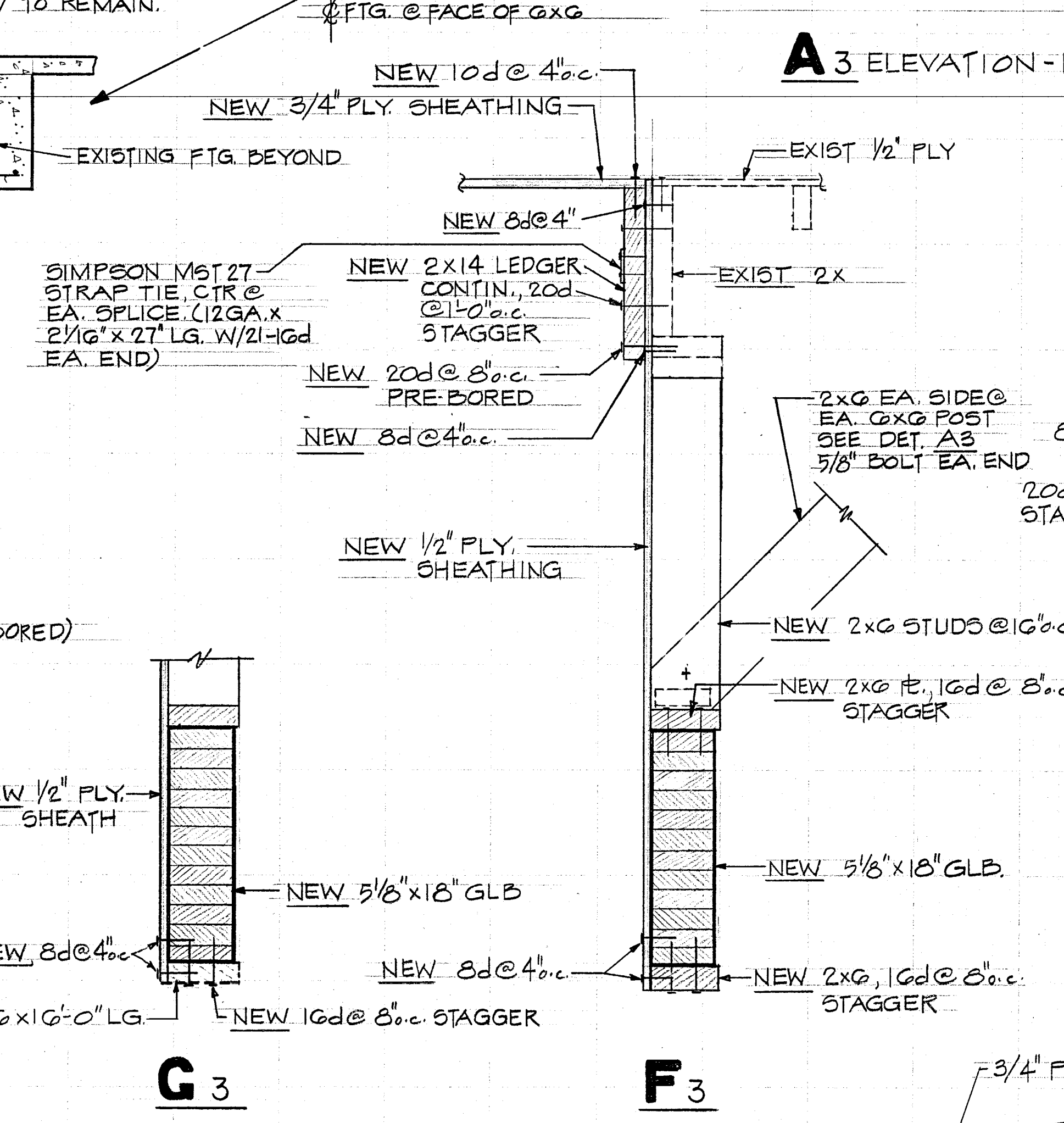

**F3**

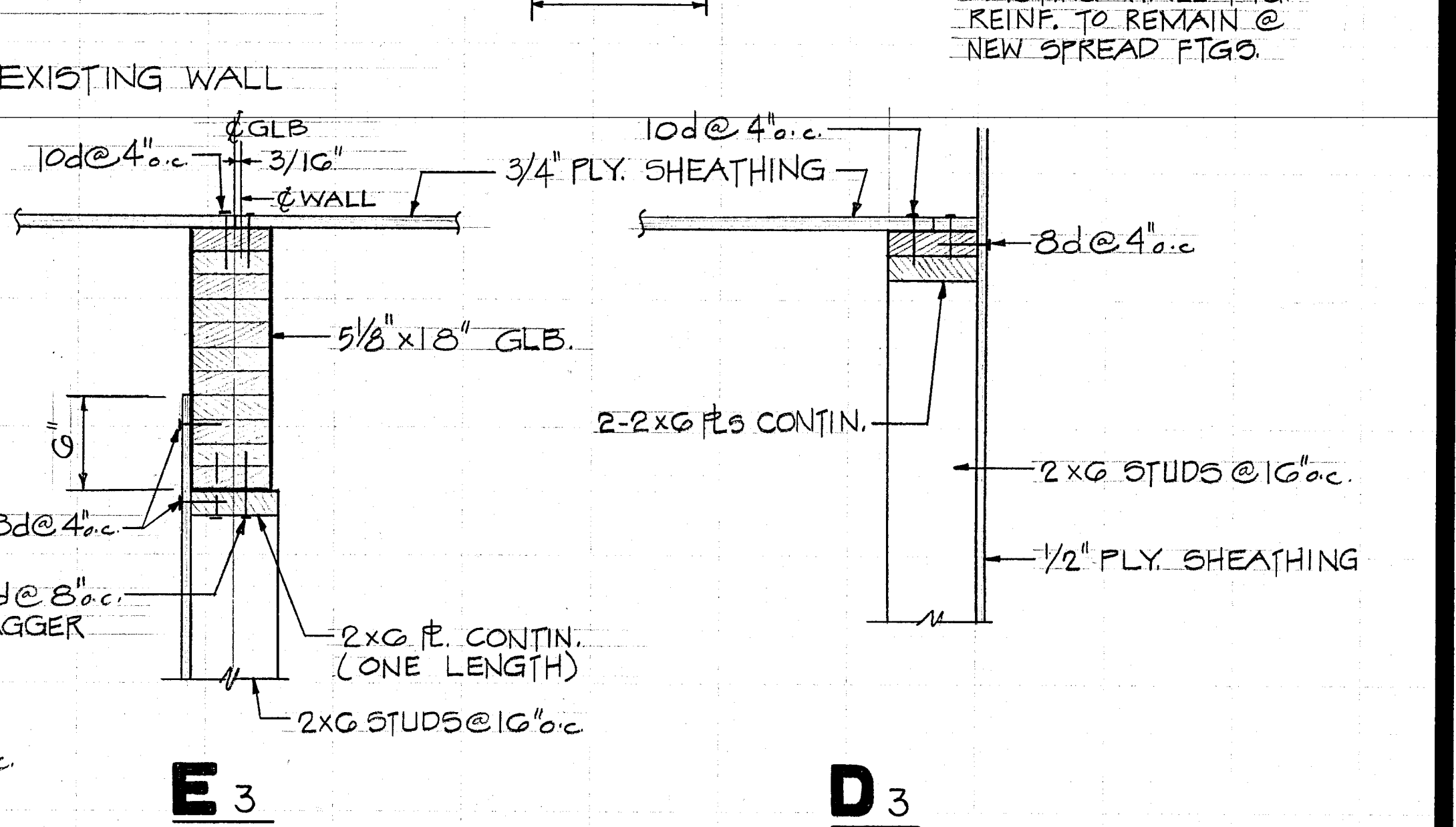

**E3**

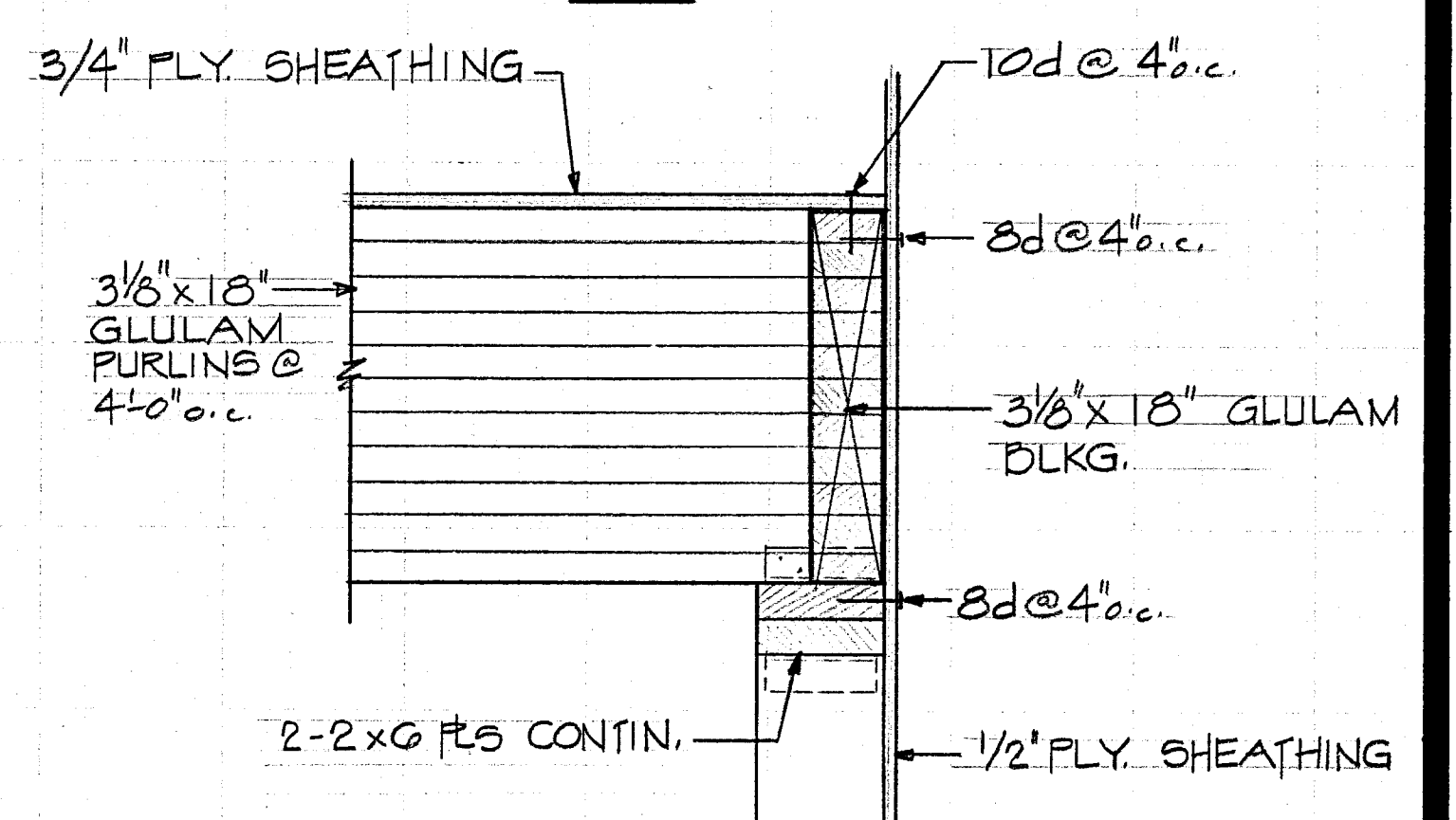

**D3**

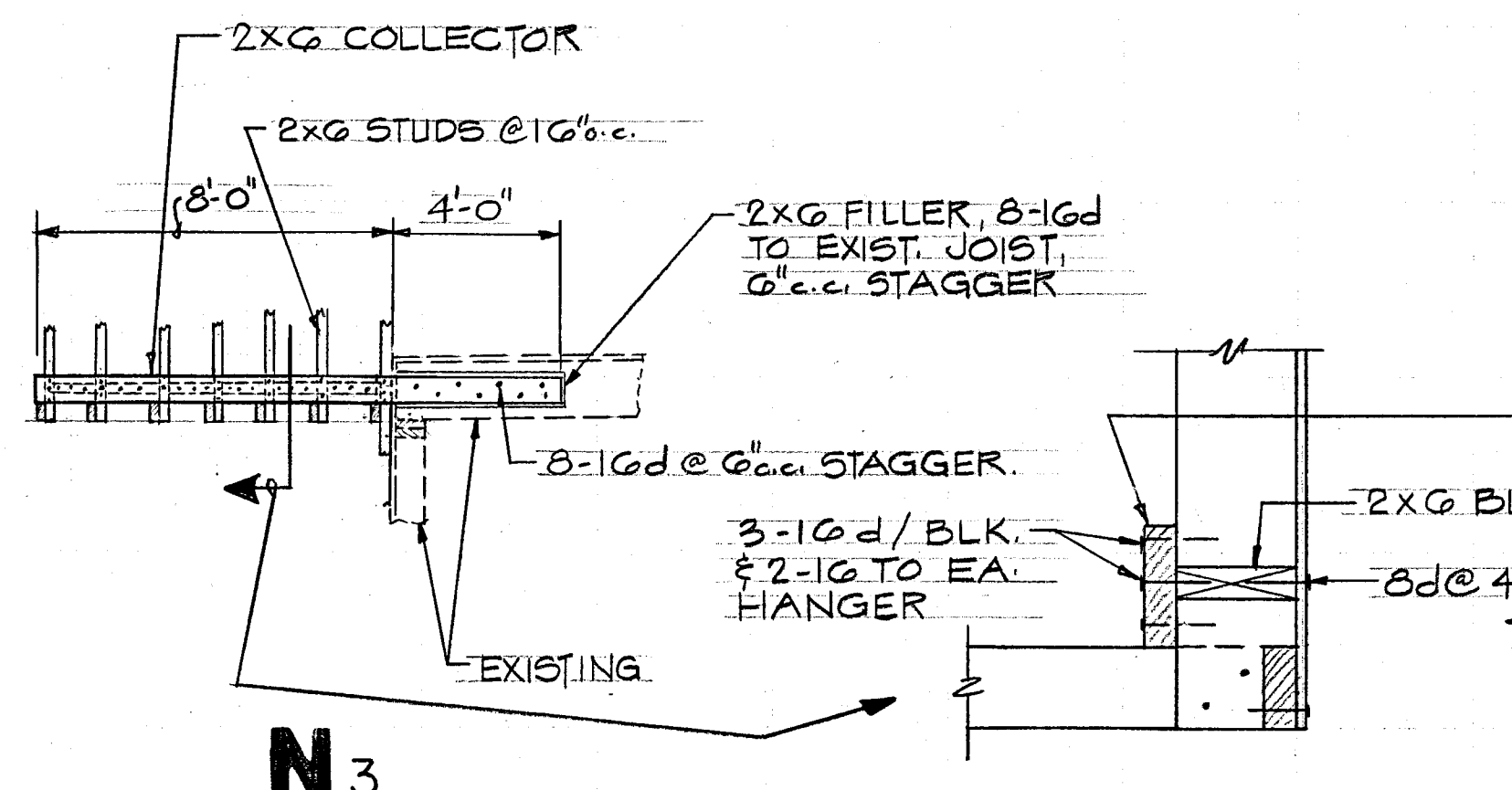

**N3**

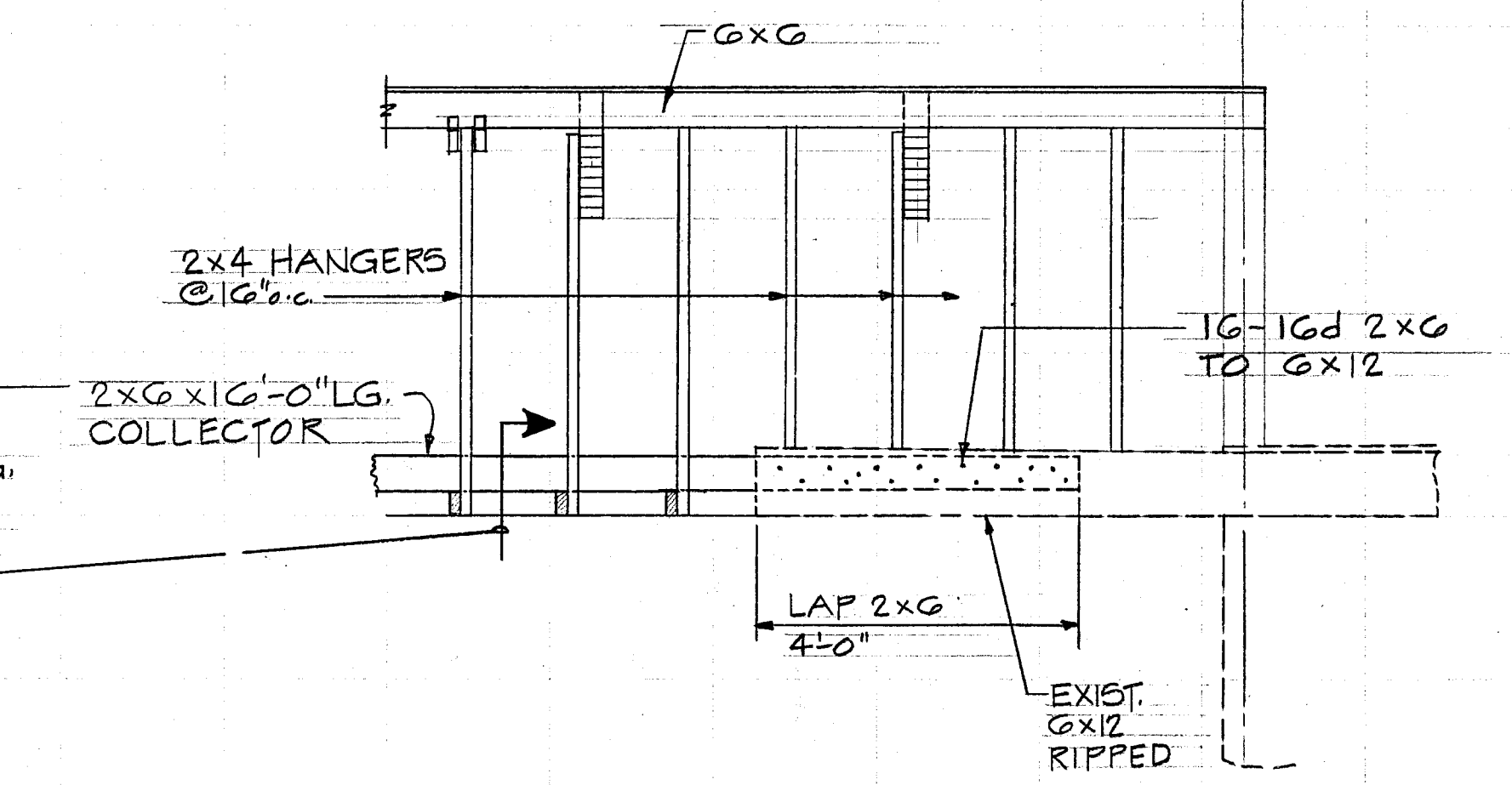

**M3**

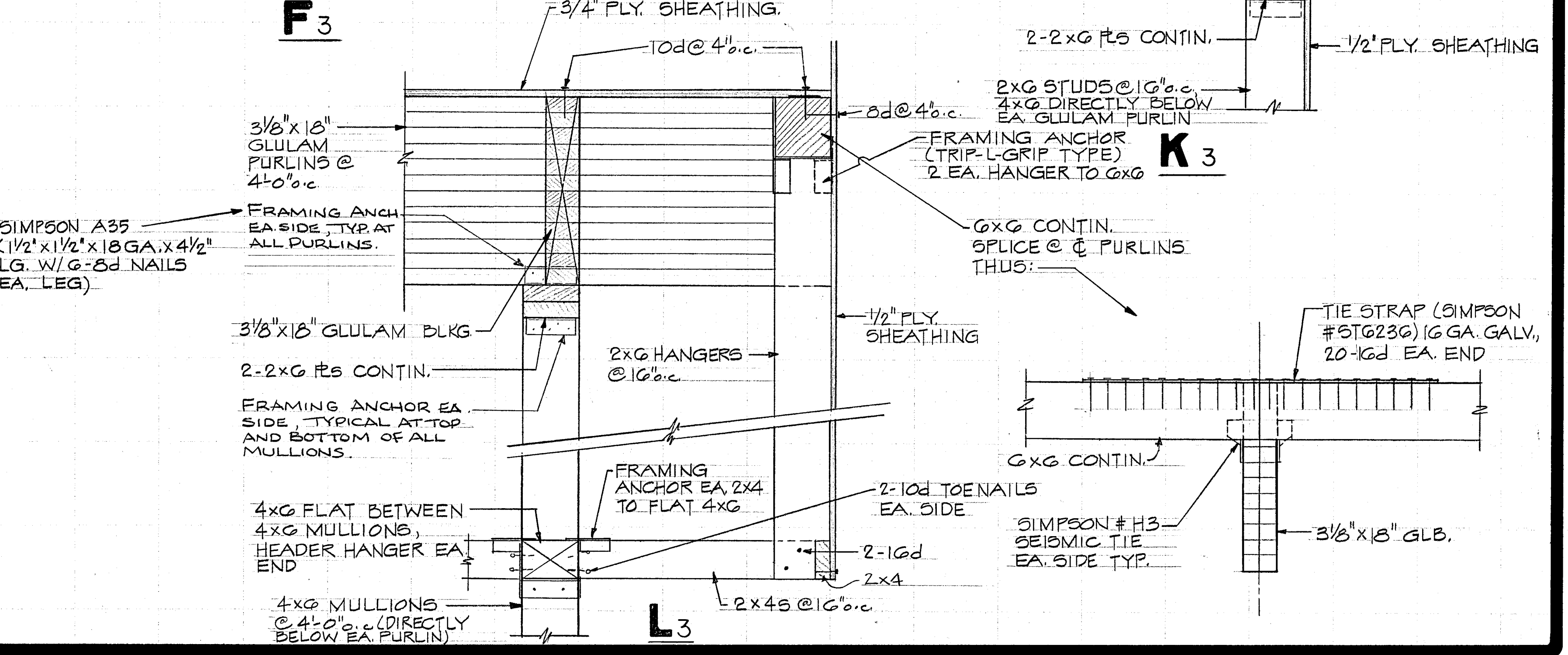

**L3**



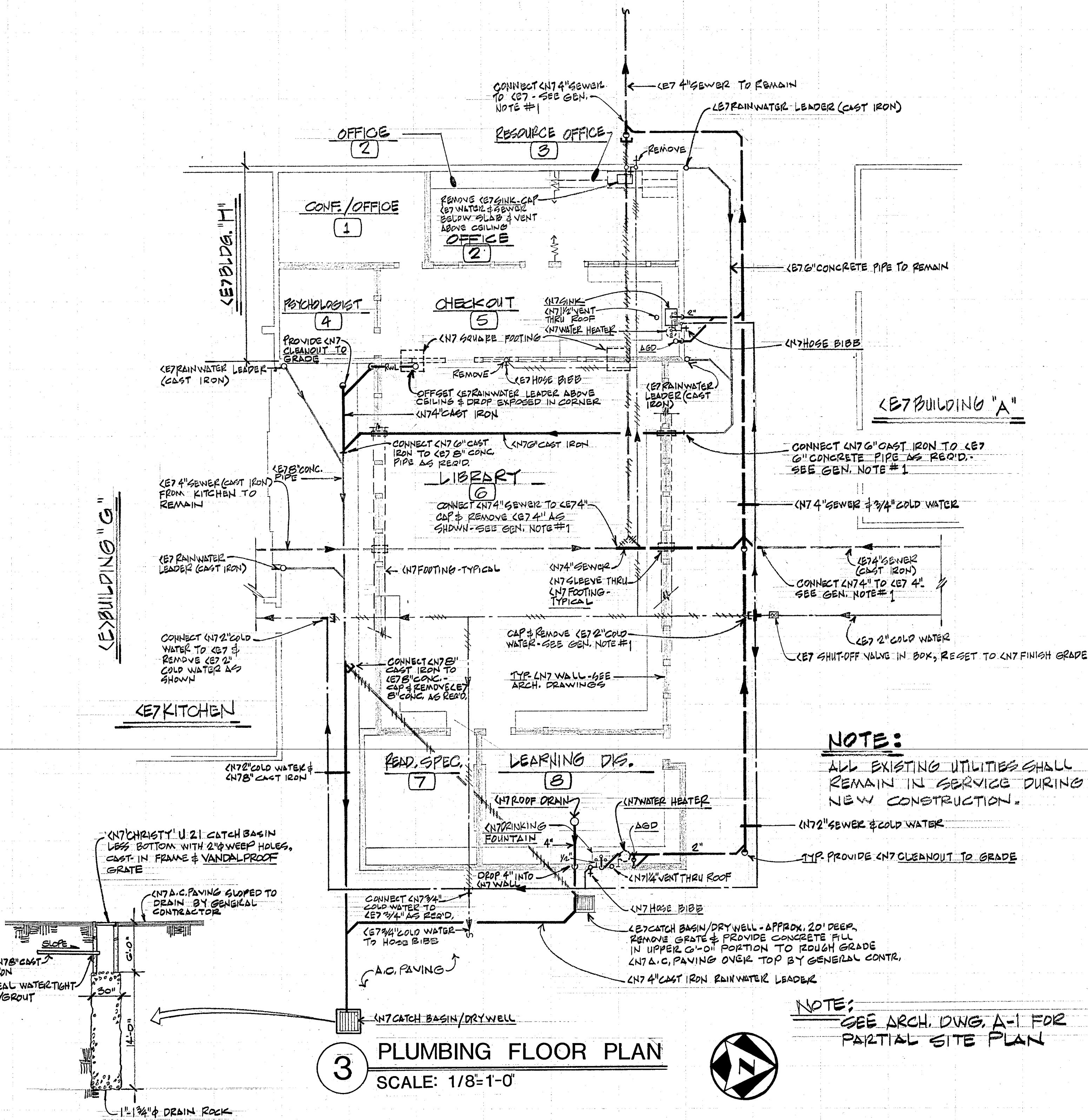

**3 PLUMBING FLOOR PLAN**  
SCALE: 1/8"=1'-0"

**NOTE:**  
ALL EXISTING UTILITIES SHALL REMAIN IN SERVICE DURING NEW CONSTRUCTION.

**NOTE:**  
SEE ARCH. DWG. A-1 FOR PARTIAL SITE PLAN

**PLUMBING GENERAL NOTES**

- VISUALLY VERIFY EXACT LOCATION, INVERT ELEVATION AND SIZE OF EXISTING LINES BEFORE TRENCHING FOR NEW WORK.
  - COORDINATE ALL WORK TO AVOID CONFLICTS WITH ALL OTHER TRADES. RUN ALL PIPING TO AVOID ARCHITECTURAL OPENINGS, DUCTS, STRUCTURAL MEMBERS OR OTHER OBSTRUCTIONS. OFFSET PIPING WHERE REQUIRED.
  - OPENING AND PATCHING OF EXISTING WALLS, CEILINGS, PAVING & SLABS SHALL BE BY GENERAL CONTRACTOR.
  - RELOCATING OF EXISTING STORM DRAINAGE SYSTEM IS PLUMBING WORK.
- (N) SINK: AM. STD. MOD. 7013.014, 24" X 21" WITH HANS #5515 FAUCET, #4112.021 STRAINER, 17 GA. CHROME PLATED P-TRAP SPEEDWAY STR-1715A STOPS AND STAINLESS STEEL HUDER RIM. MODIFY LEDGE FOR SINGLE DRILLING.
- (N) DRINKING FOUNTAIN: HANS MOD. 4120, 30" X 20" WITH HANS #5515 FAUCET, 5002 BUBBLER, 6456 STRAINER, 17 GA. CHROME PLATED P-TRAP, SPEEDWAY STR-1715A STOPS AND STAINLESS STEEL HUDER RIM.
- (N) HOSE BIBB: ACORN NO. 8121 WITH INTEGRAL VACUUM BREAKER.
- (N) CLEANNOUT TO GRADE: J.R. SMITH FIG. 4286, PROVIDE CHRISTY G-5 BOX AND CAST IRON LID MARKED "SEWER".
- (N) AIR GAP DRAIN: J.R. SMITH FIG. 3950, SIZE 1-1/2" COMPLETE WITH FIG. 2699 TRAP PRIMER.
- (N) WATER HEATER: STATE MOD. CV-6-1MS7-K, 6 GAL. CAP. 2000 WATTS COMPLETE WITH SANDROSE ELEMENT AND CASH-ACME MOD. FVX-5 P.C.P. RELIEF VALVE. HEATER SHALL COMPLY TO TITLE 24 REQUIREMENTS FOR ENERGY EFFICIENCY. 10/4/100
- (N) ROOF DRAIN: J.R. SMITH MODEL 1010-C-R, SIZE 3" COMPLETE WITH CAST IRON DOME.

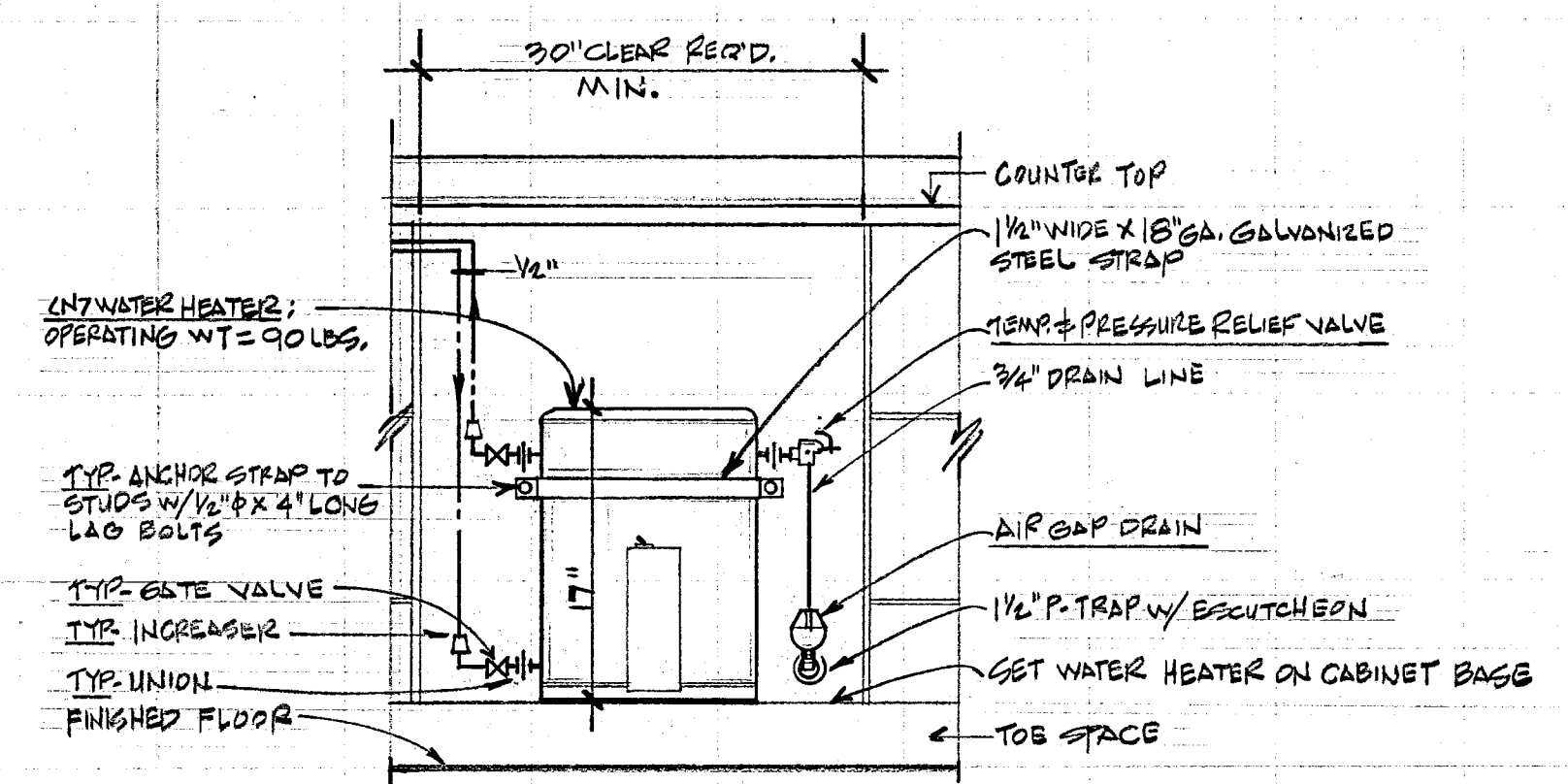

**WATER HEATER PIPING DIAGRAM**  
NO SCALE

MARK	NECK SIZE	SERVICE	TYPE	MODEL NO. "BARBER-COLMAN"
1	8"φ	CEILING SUPPLY	PERFORATED	816 - P85N
2	10"φ	"	"	1024 - P85N
3	10"φ	"	"	1024 - P85J
4	8"φ	"	"	824 - PDLJ
5	10"φ	"	"	1024 - PDLJ
6	30" x 8"	SIDEWALL SUPPLY	REMOVABLE CORE	30 x 8 1A - GMAY
7	8" x 8"	CEILING RETURN	PERFORATED	824 - PELV
8	10" x 10"	"	"	1024 - PELV
9	17" x 17"	"	"	1724 - PEEN
10	8"φ	TRANSFER	"	824 - PDS
11	12" x 12"	RELIEF	CONTINUOUS	12 x 12 - TXE
12	24" x 24"	"	"	24 x 24 - TXE
13	24" x 24"	RETURN	"	24 x 24 - TXEV
14	30" x 6"	RELIEF	INTEGRAL CORE	30 x 6 - GES
15	38" x 6"	"	"	38 x 6 - GES

MARK	MANUFACTURER AND MODEL NO.	TYPE	CFM	TOTAL SP	HP	SERVICE	COOLING COIL #	AIR	WATER	OPER. VLT (L.D.A.)	
FC-1	TRANE #8 AL1	DRAW-THERM	3100	1.0"	1	120/1/60	3100	700 24.5	154.45'	0.4	1000

\* THE COIL SHALL BE A TYPE W-SERIES 16, 4-ROW COIL AND SHALL BE USED FOR BOTH HEATING AND COOLING.

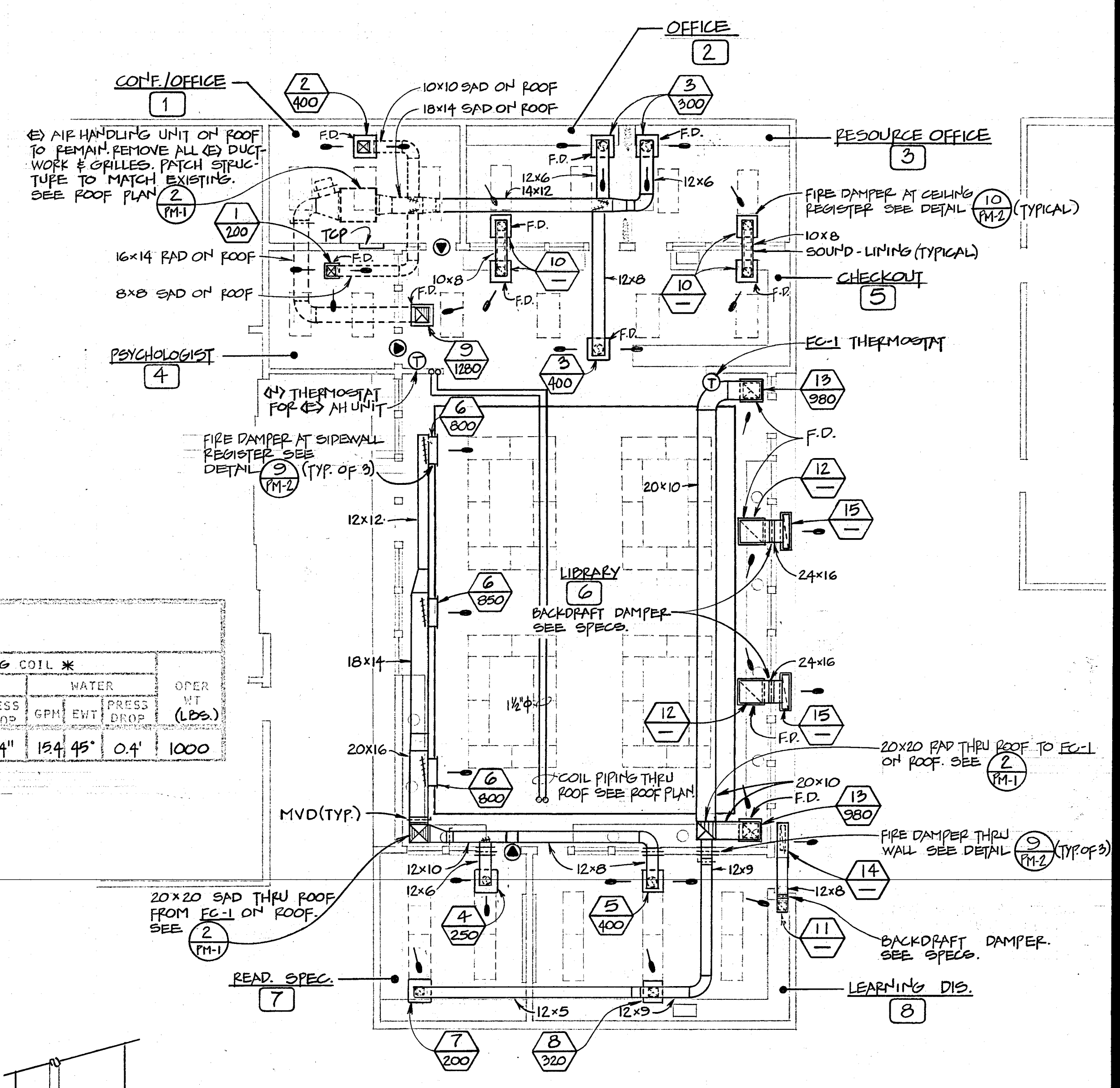

**1 MECHANICAL FLOOR PLAN**  
SCALE: 1/8"=1'-0"

- MECHANICAL GENERAL NOTES**
- PROTECT ALL FACILITIES FROM DUST AND DAMAGE DURING CONSTRUCTION.
  - VERIFY EXACT SIZE AND LOCATION OF EXISTING EQUIPMENT PRIOR TO CONSTRUCTION.
  - COORDINATE ALL WORK TO AVOID CONFLICT WITH OTHER TRADES.

**AS BUILT FOR REFERENCE ONLY**

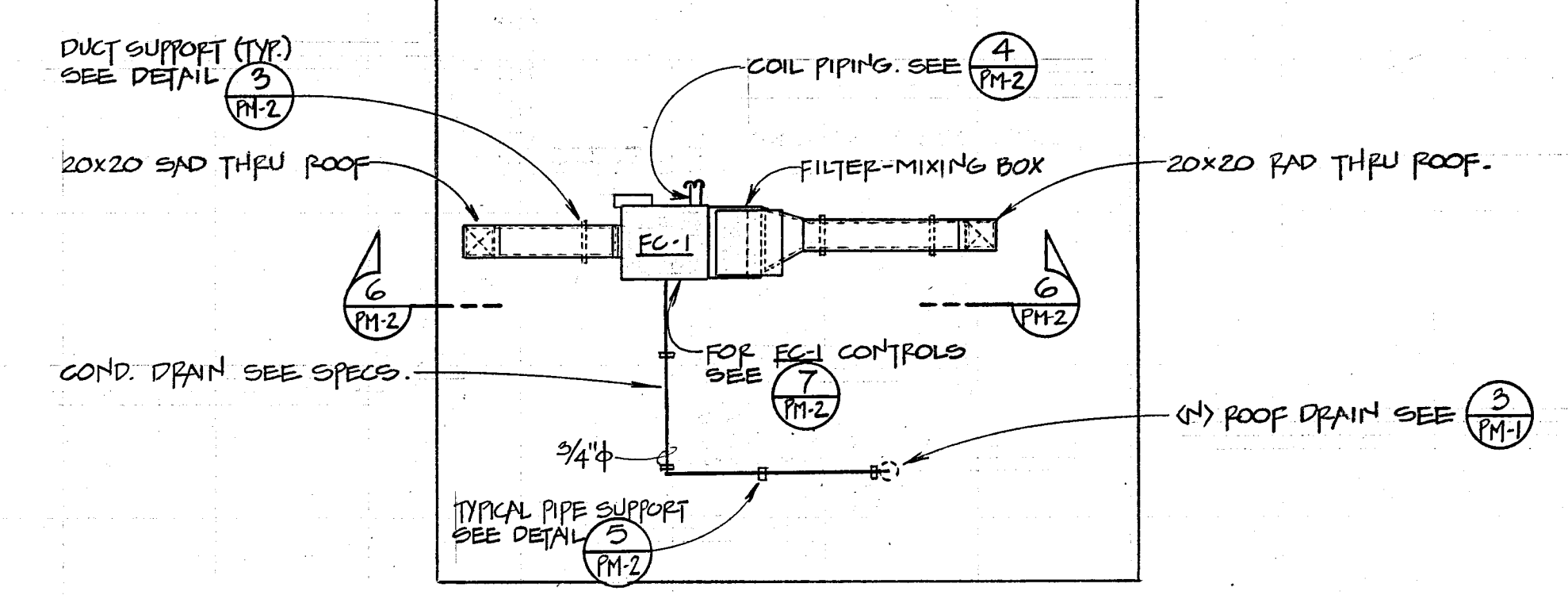

**2 ROOF PLAN**  
SCALE: 1/8"=1'-0"

**MANZAGOL ARCHITECTS, A.L.A.**  
 PORTER JENSEN HANSEN MANZAGOL  
 400 WASHINGTON STREET, SUITE 200, OAKLAND, CALIFORNIA 94612  
 PHONE: (415) 778-1000  
 FAX: (415) 778-1001  
 WWW: WWW.MANZAGOL.COM  
 PROJECT NO. 151979  
 DATE: 02-15-07  
 SHEET NO. 7750-T  
 LIBRARY ADDITIONS TO YOYON ELEMENTARY SCHOOL, BERKESSA UNION SCHOOL DISTRICT







